

# **MANUÁL PRO UČITELE ČESKÉHO JAZYKA PRO CIZINCE BEZ ZNALOSTI LATINKY**

## **HANDOUTY**



**Člověk v tísni – společnost při ČT, o. p. s.  
Projekt Varianty Equal**

**Autorský tým:**

Jana Čemusová

Petra Huková

Ondřej Štindl

Barbora Štindlová

**Ilustrace:**

Richard Fischer

A	á
B	C
Č	D
Ď	E

É

F

G

H

CH

I

Í

J



K

L

M

N

Ň

O

Ó

P

R

Ř

T

Ť

U

Ú

Ů

V

W

Y

Ý

Z

Ž

A	Á	B	C	Č
D	Ď	E	É	F
G	H	CH	I	Í
J	K	L	M	N
Ň	O	Ó	P	R
Ř	T	Ť	U	Ú
Ů	V	W	Y	Ý
Z	Ž			

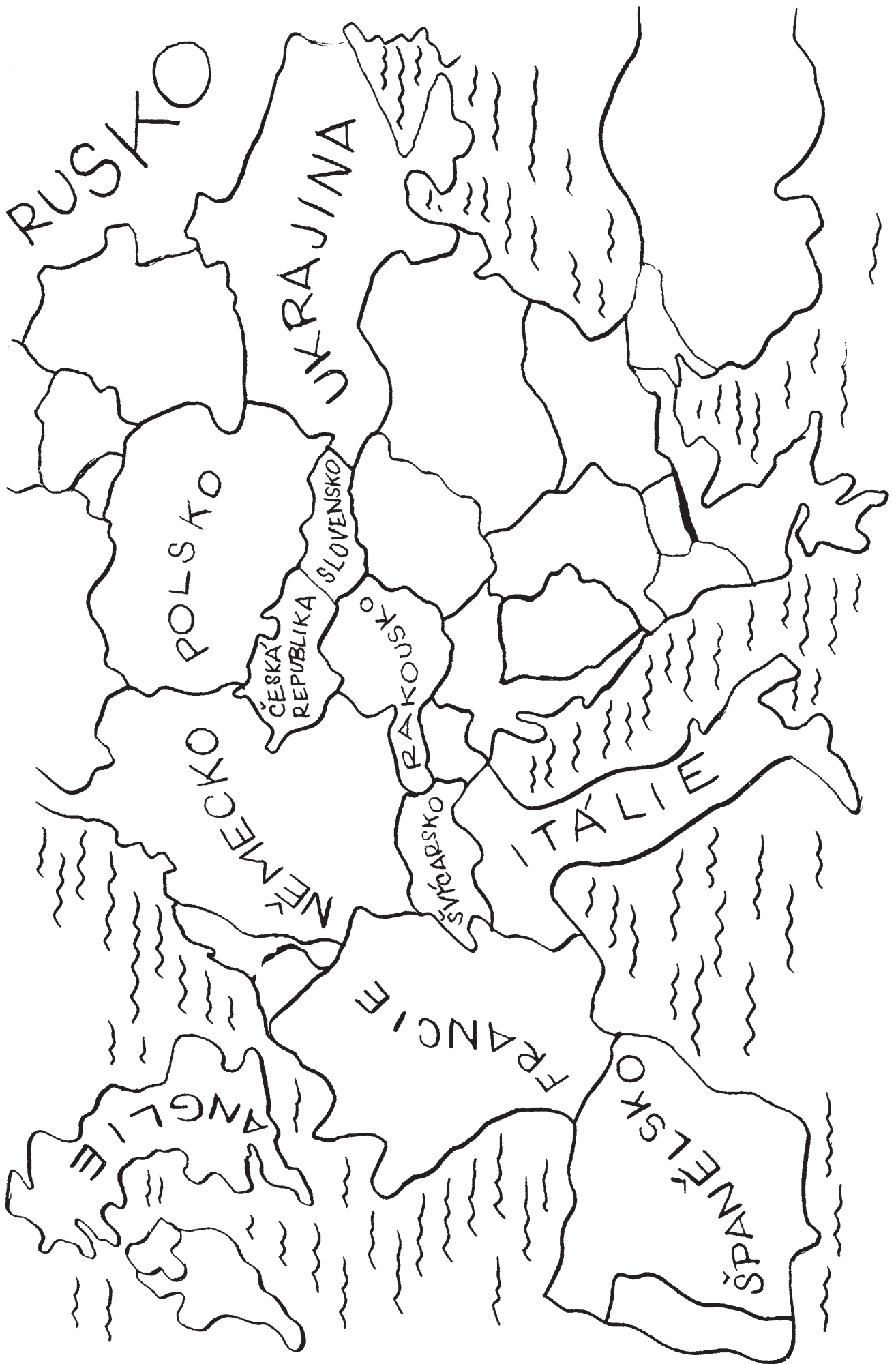

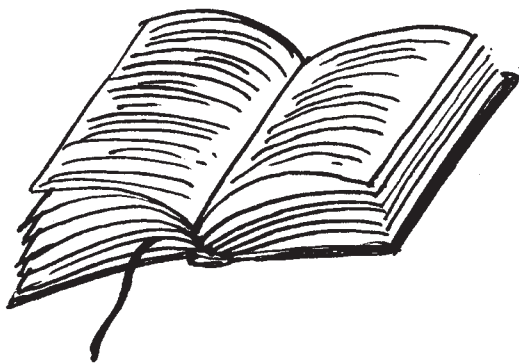
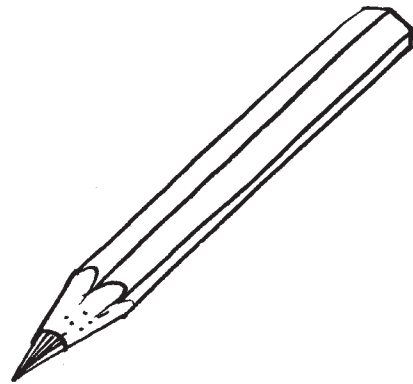
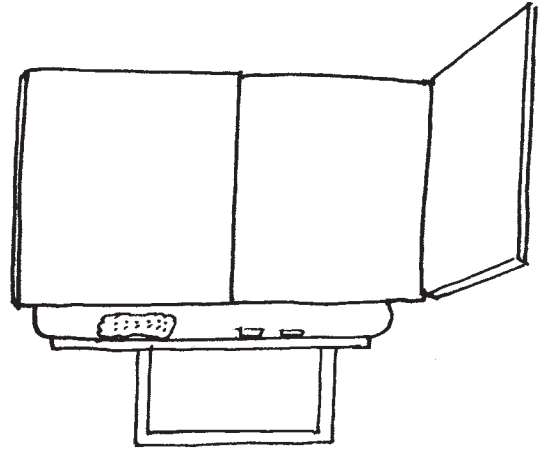
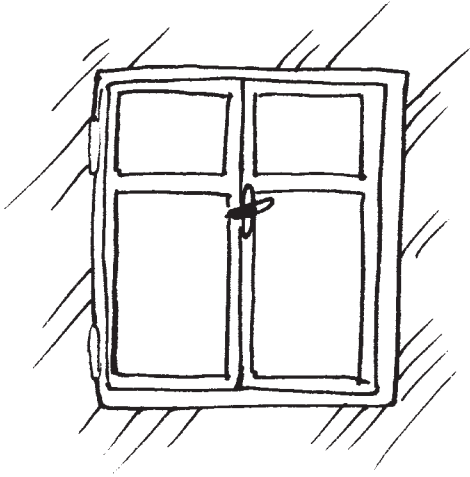
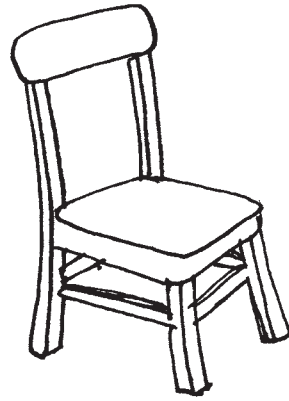

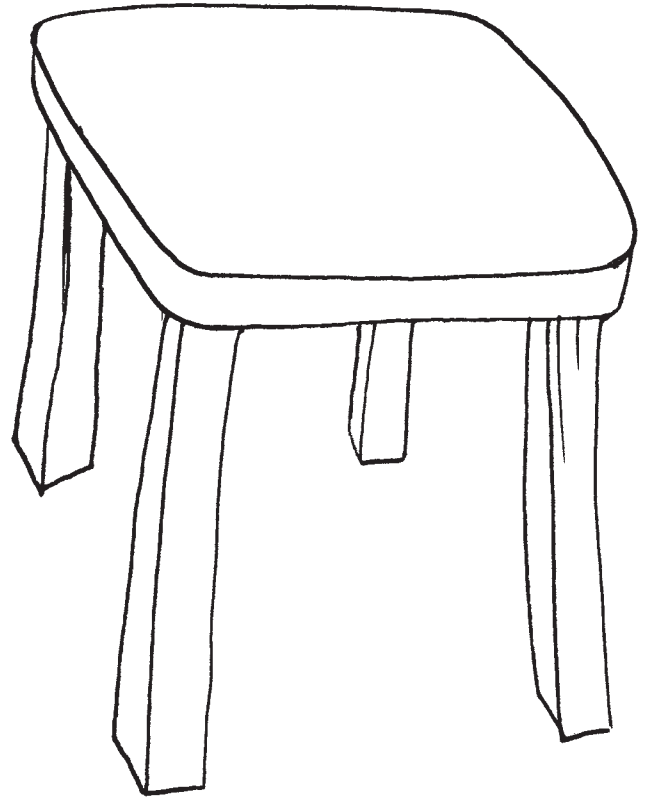
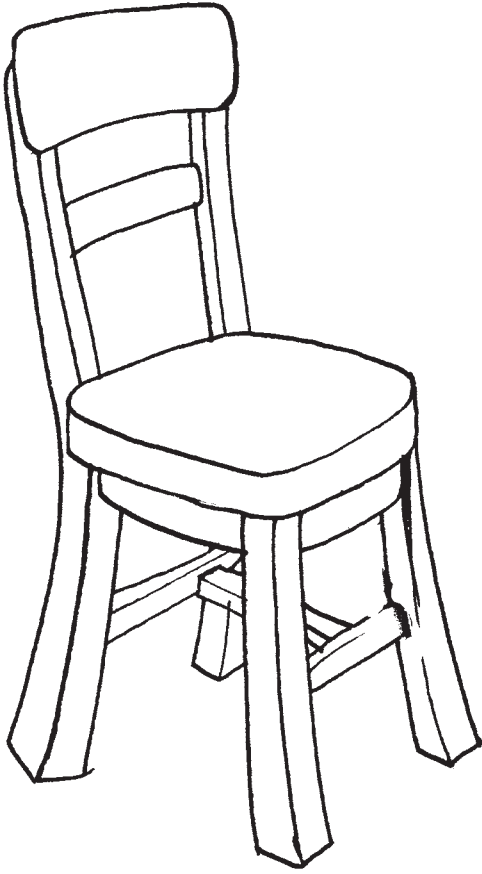



PA'N



PANI



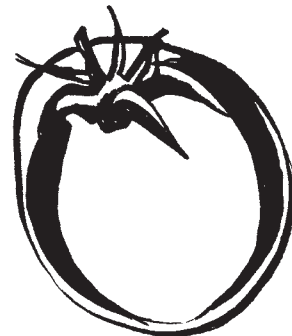
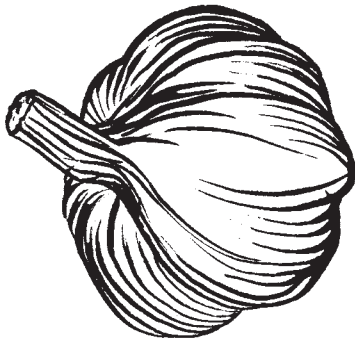
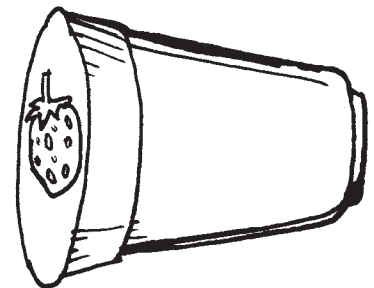
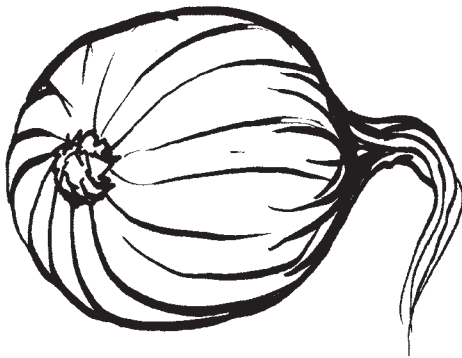
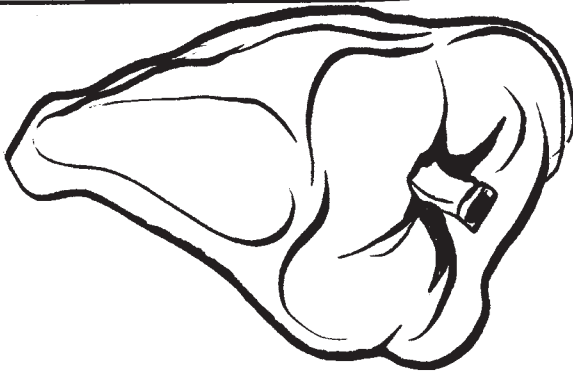
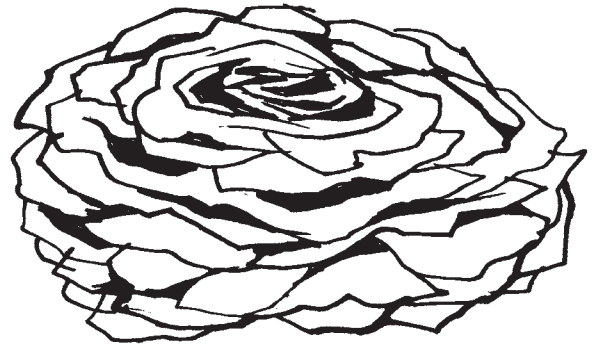
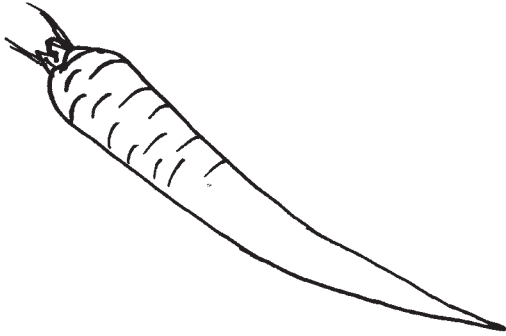
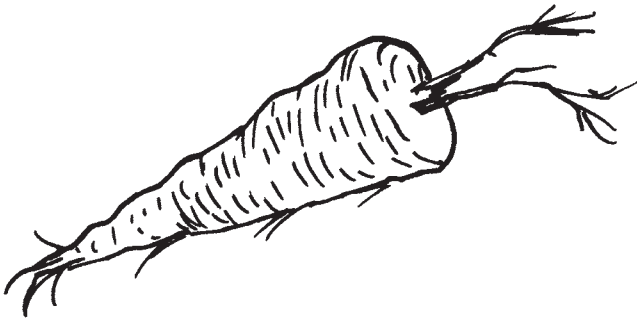

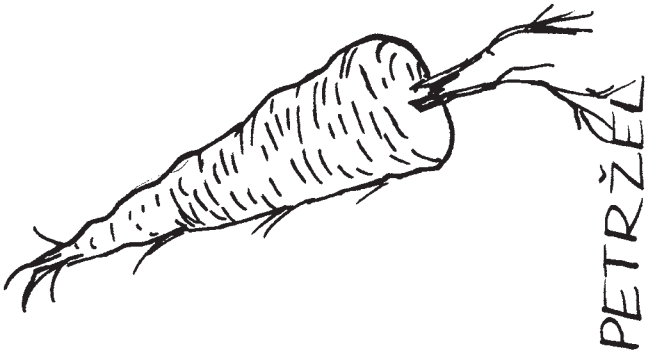

PETRŽEL

OKURKA

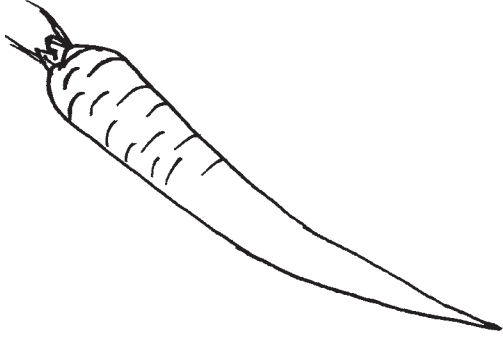

MRKEV

SALAT

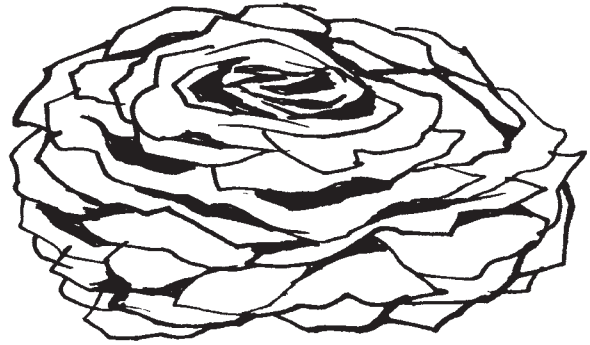

PAPRIKA

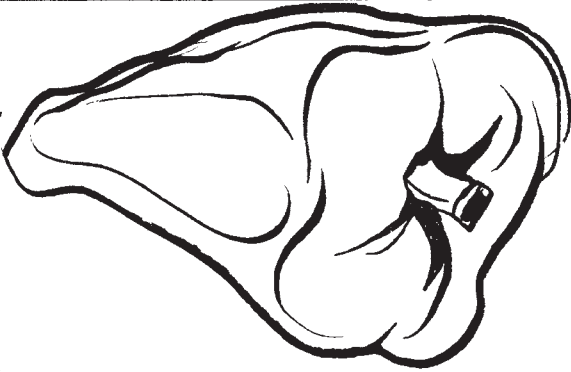

BRAMBORY

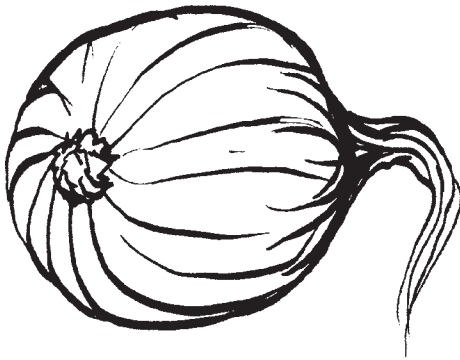

CIBULE

JOGURT

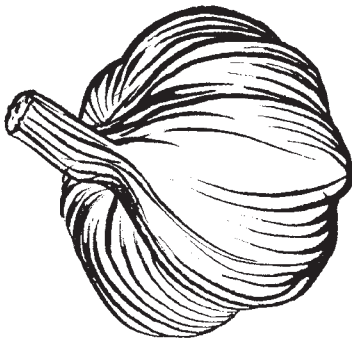
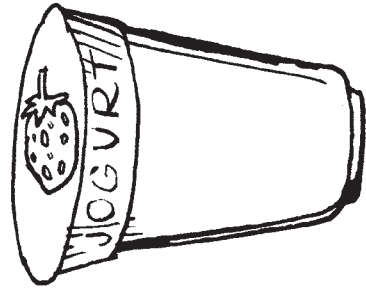

ČESNEK

RAJČE



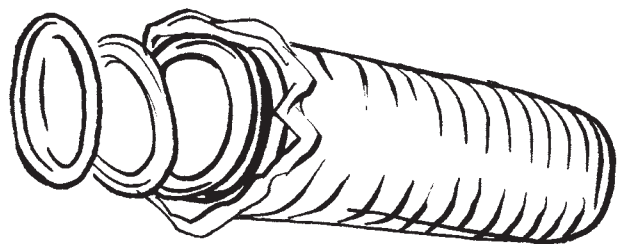
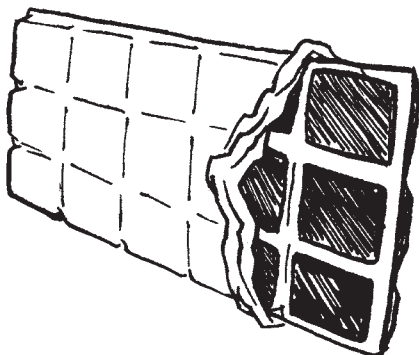
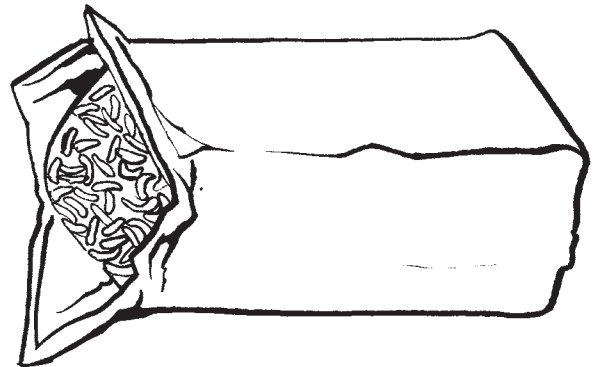
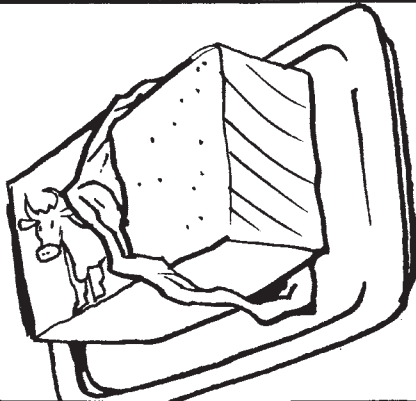
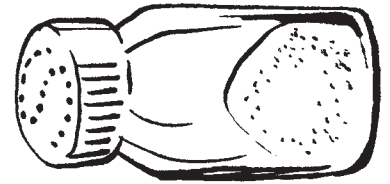
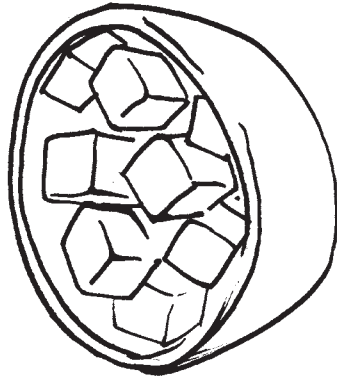
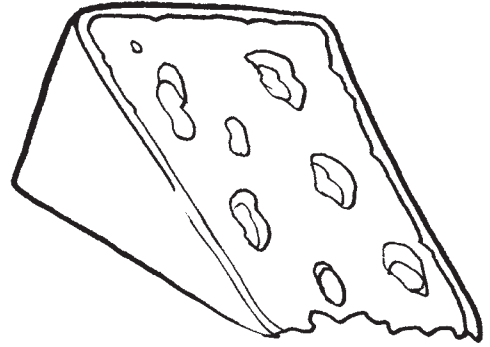
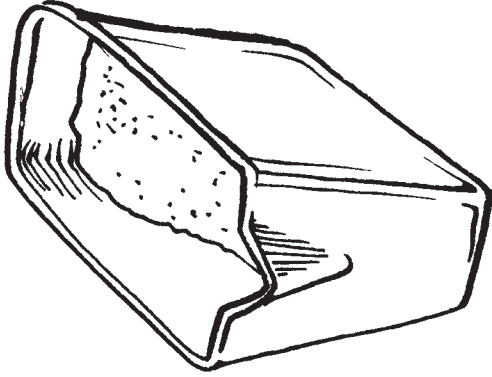
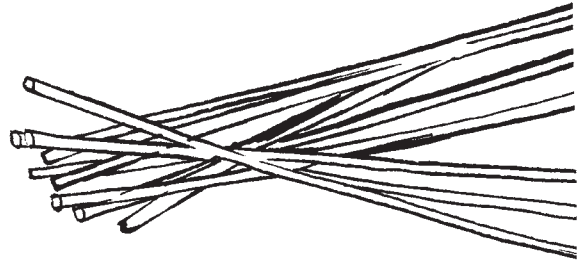
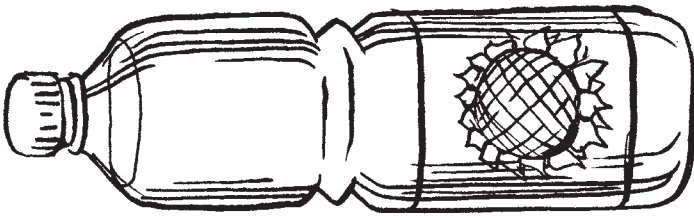

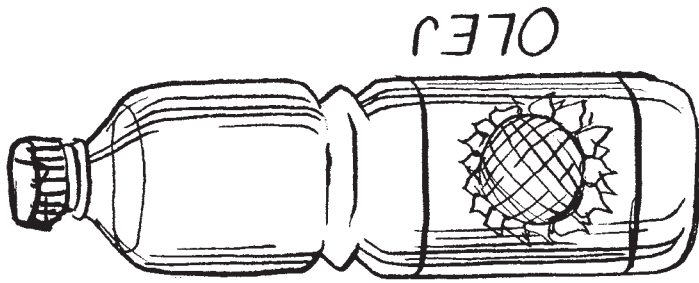

OLEJ

TĚSTOVINY

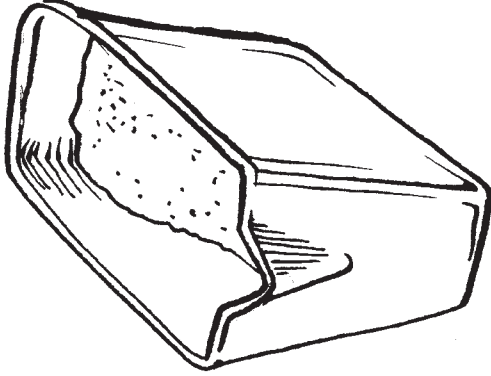
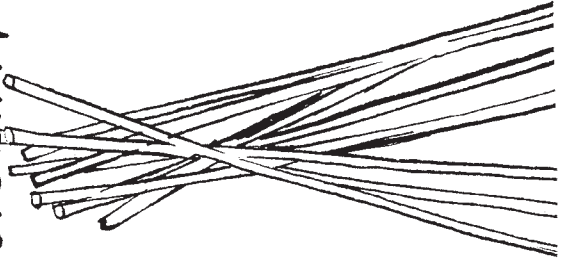

MOUKA

SYR

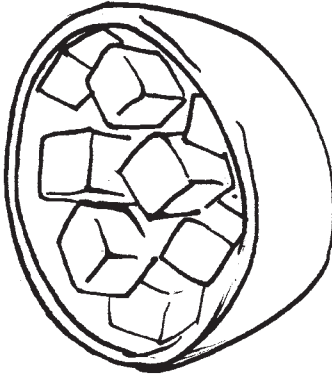
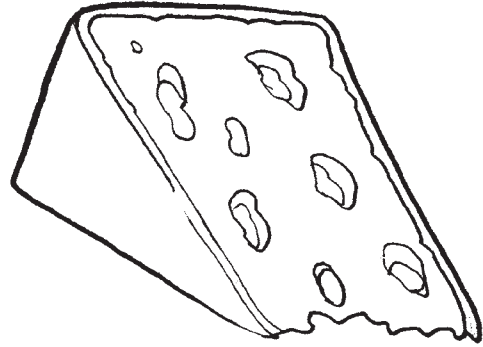

CUKR

SŮL

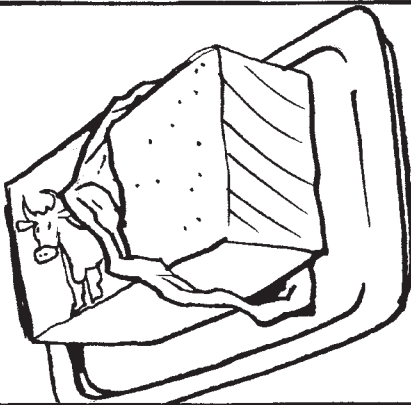
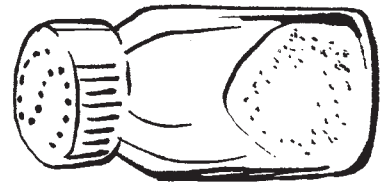

MA'SLO

RÝŽE

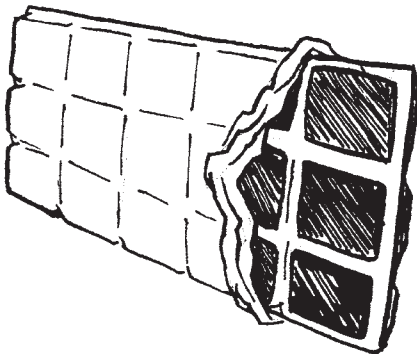
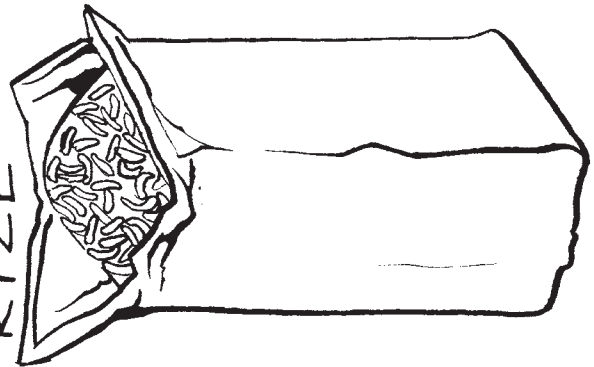

ČOKOLÁDA

SUŠENKY

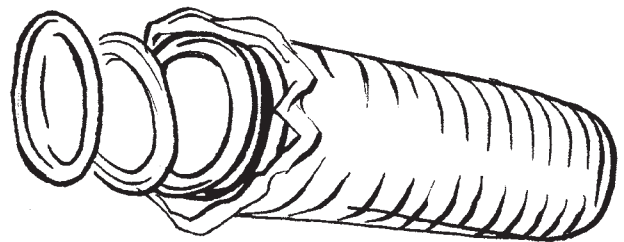

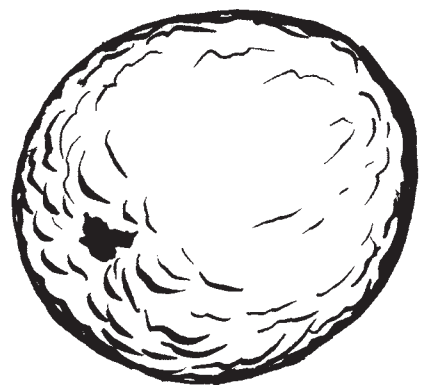
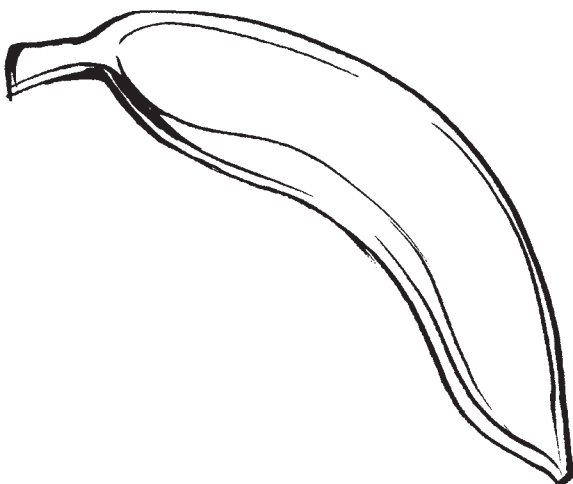
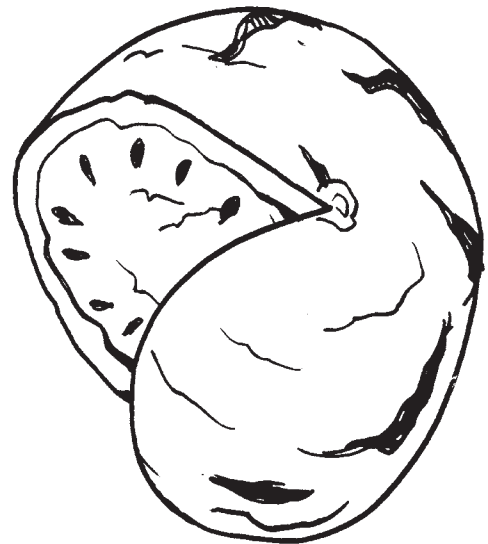
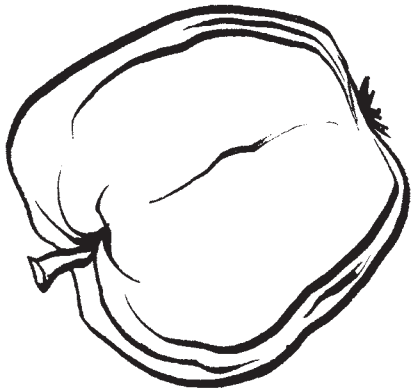
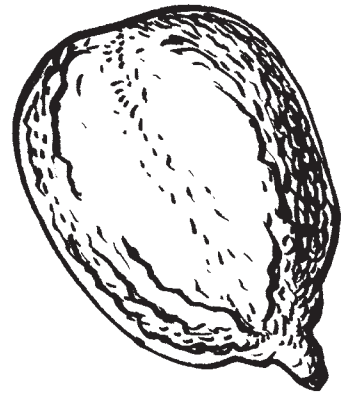
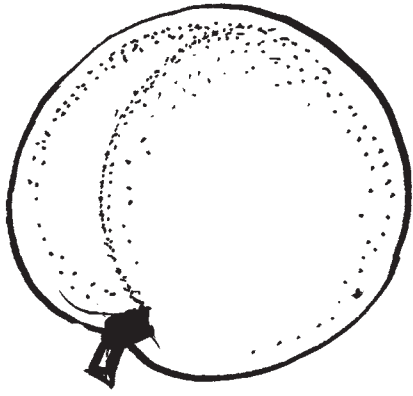

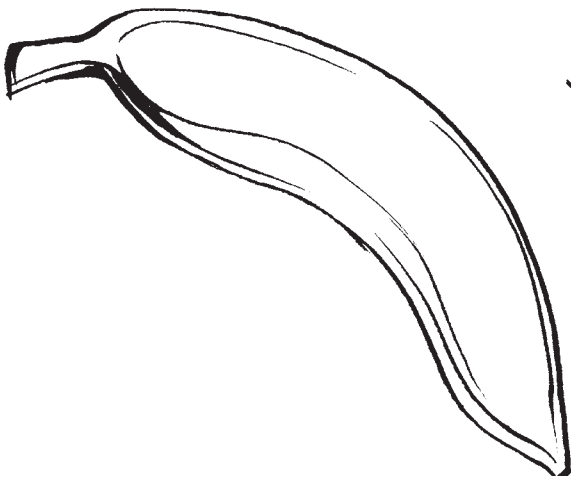

BANÁN

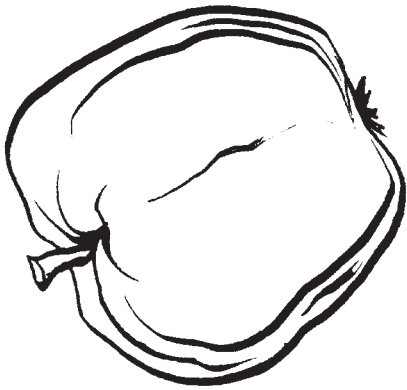

JABLKO

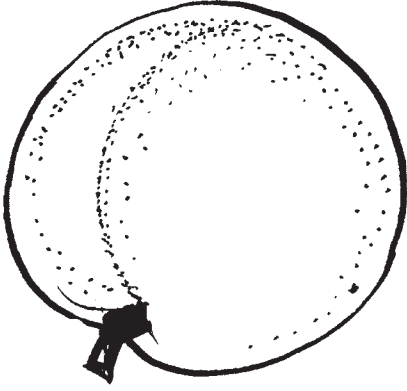

BROSKEV

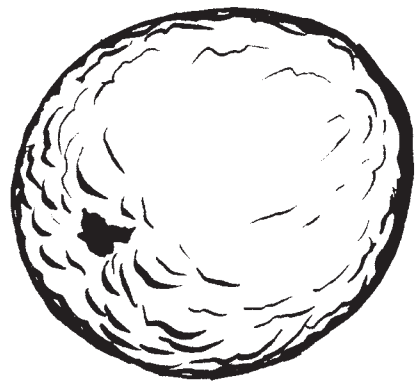

POMERANČ

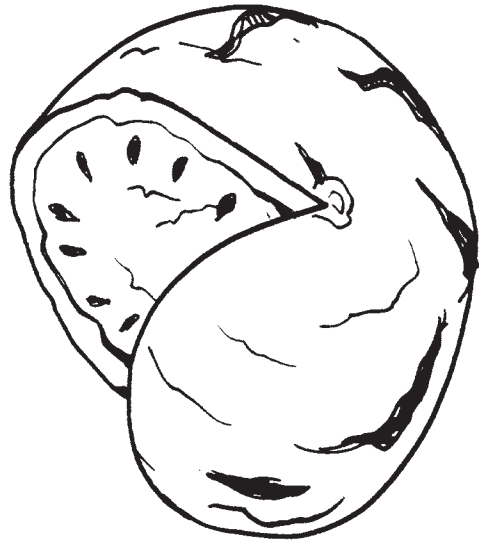

MELOUN

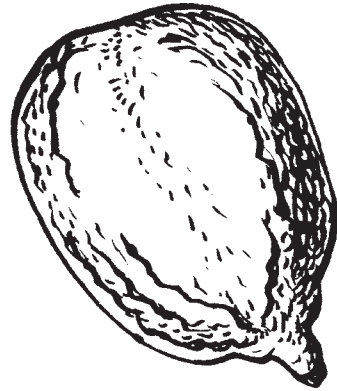

CITRON

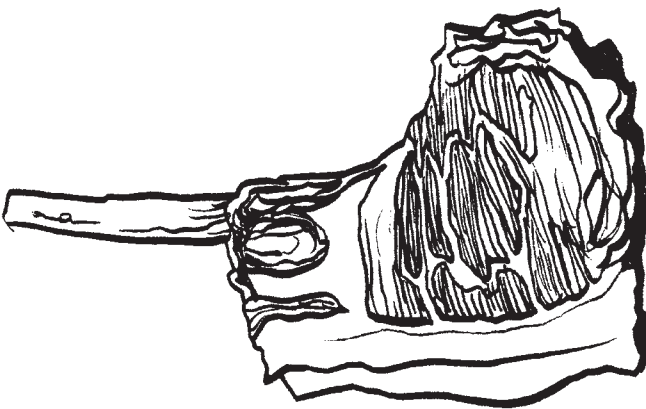
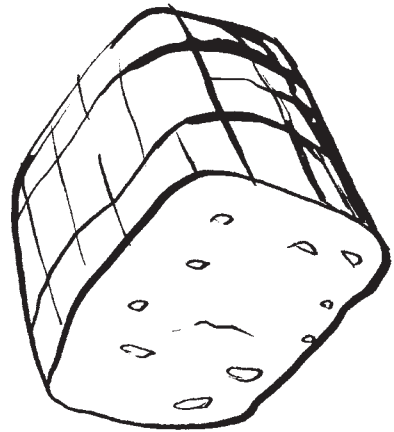
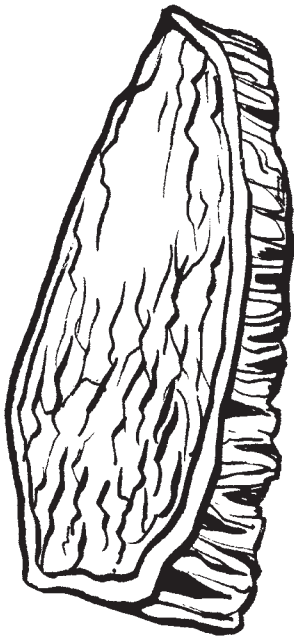
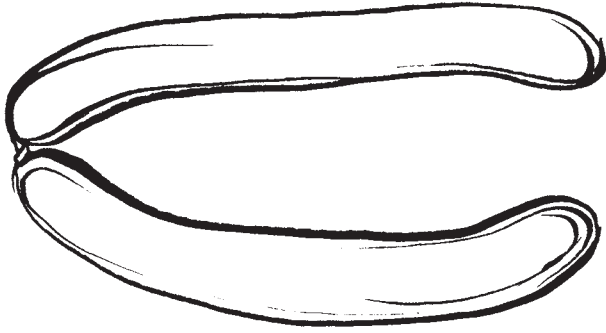



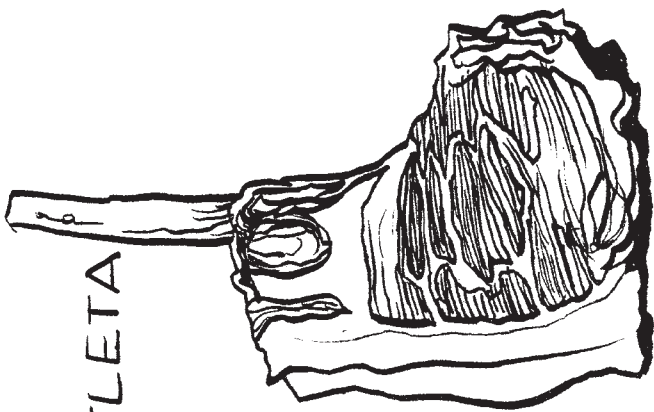

KOTLETA

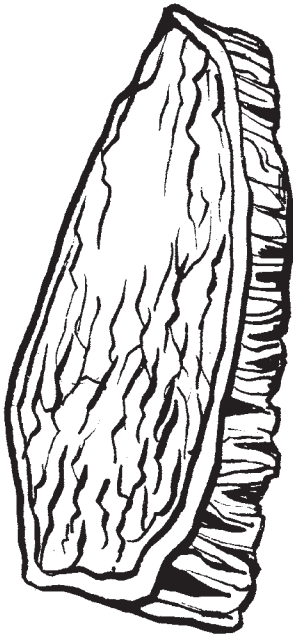

STĚAK

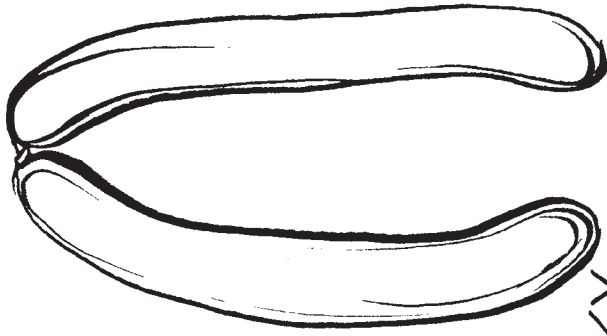

PÁRKY



STEHNO

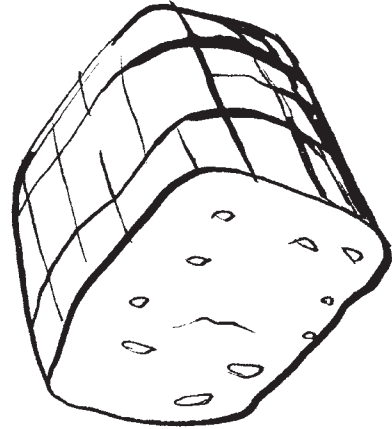

ŠUNKA



SALÁM



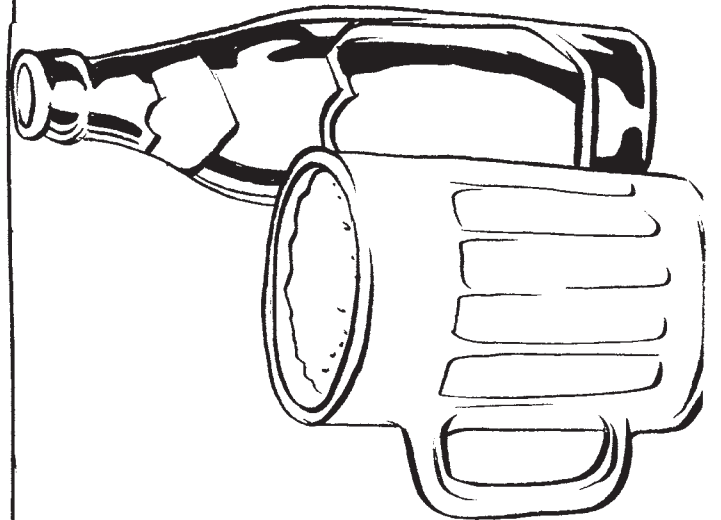
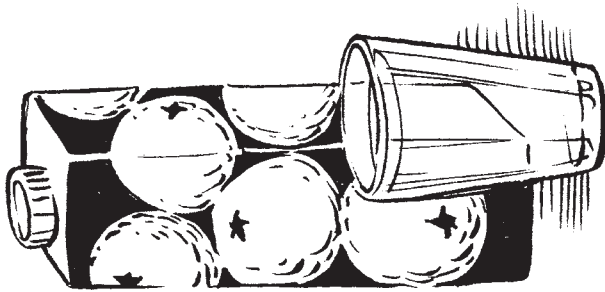
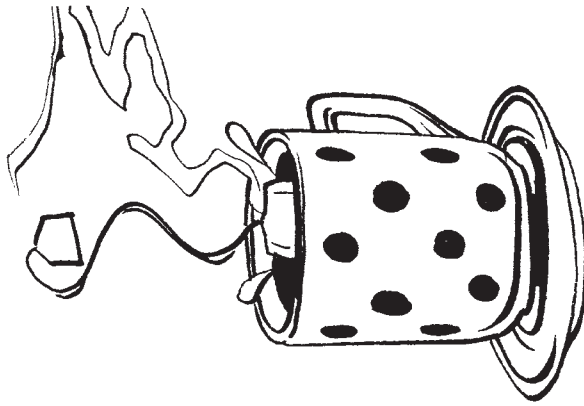
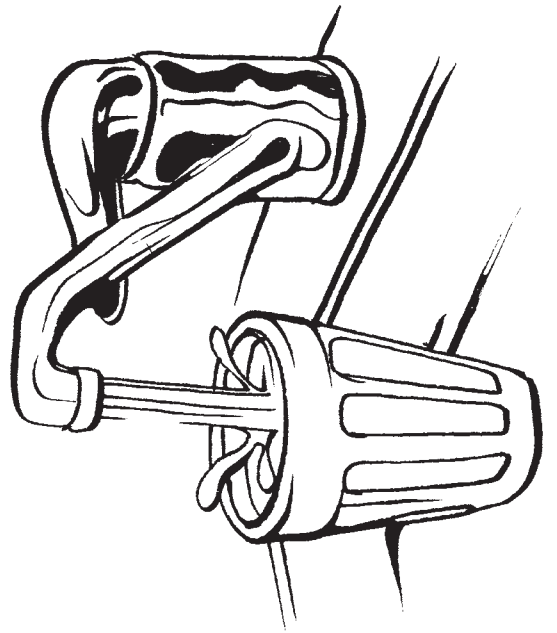
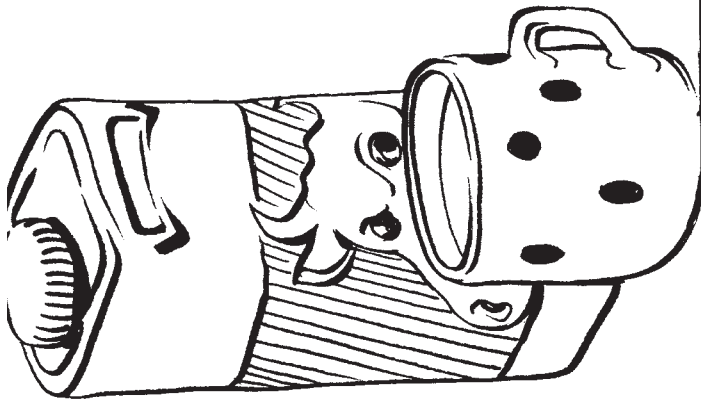

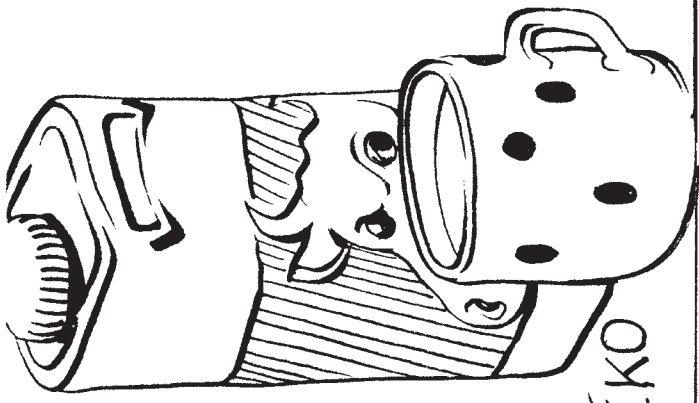

MLÉKO

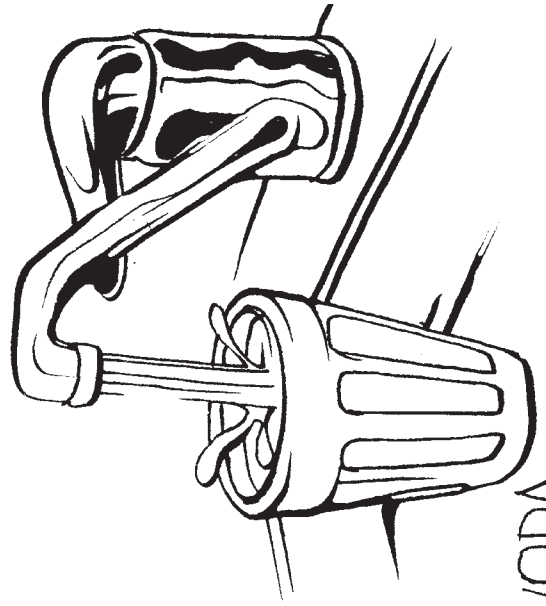

VODA

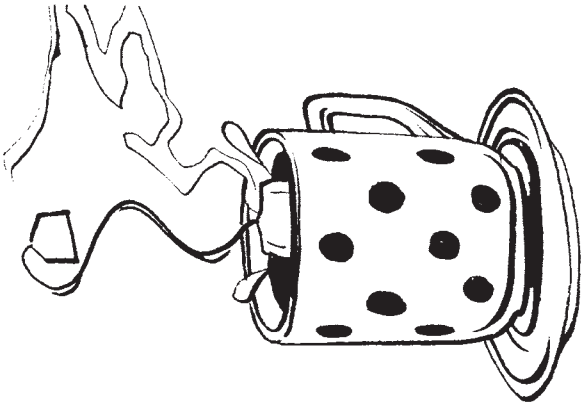

ČAJ



KÁVA

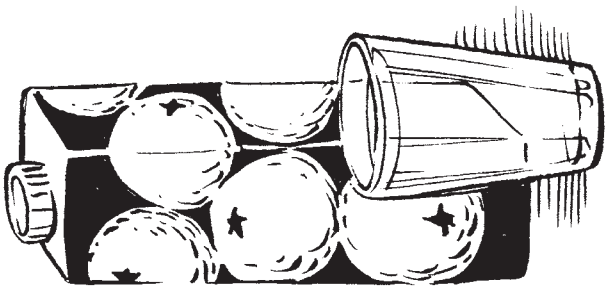

DŽUS

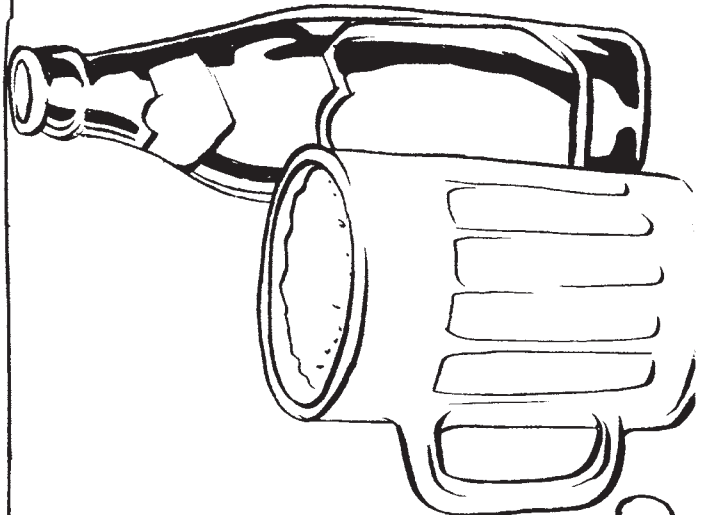

PIVO

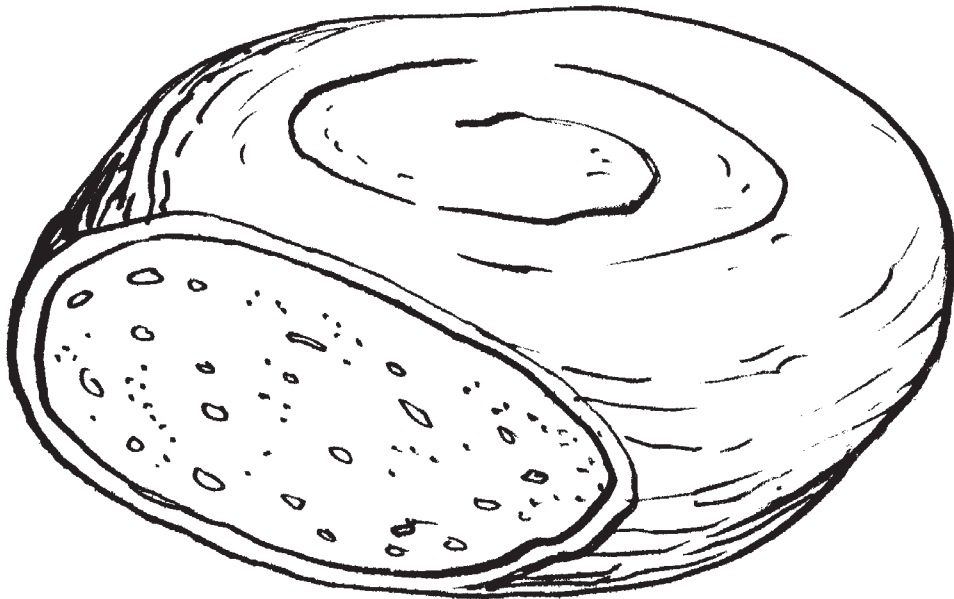
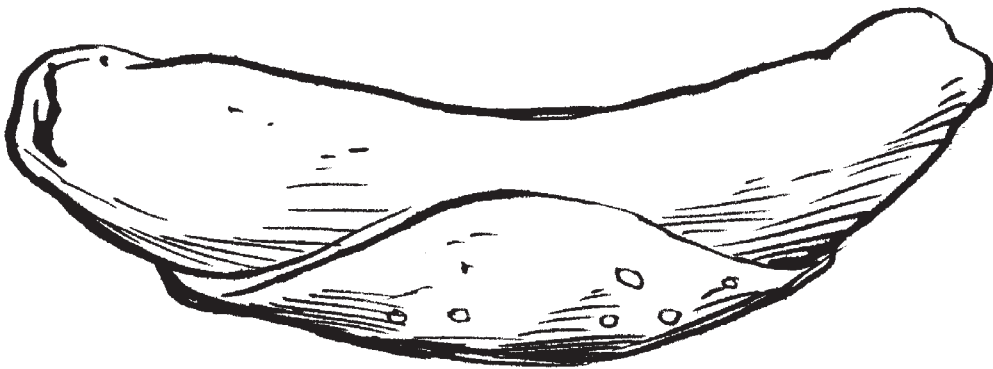



HOUSKA

---

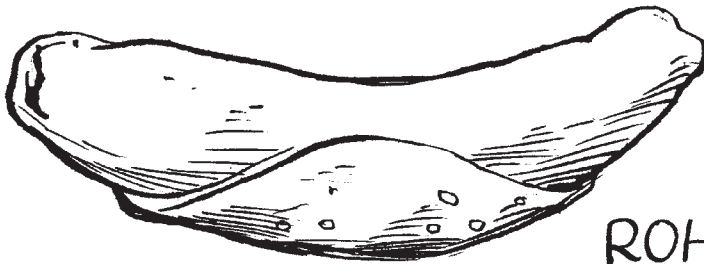

ROHLÍK

---

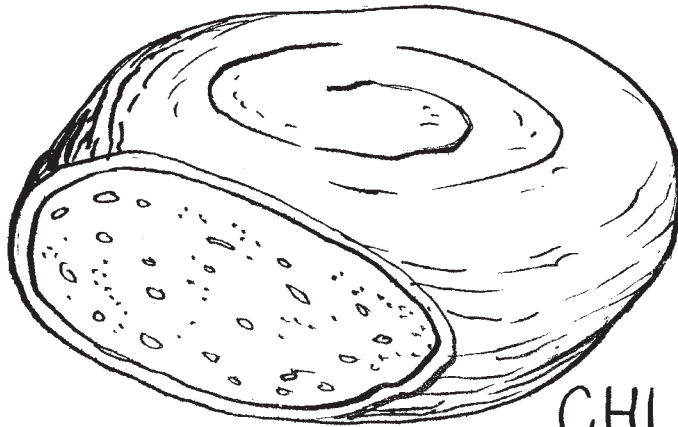

CHLÉB

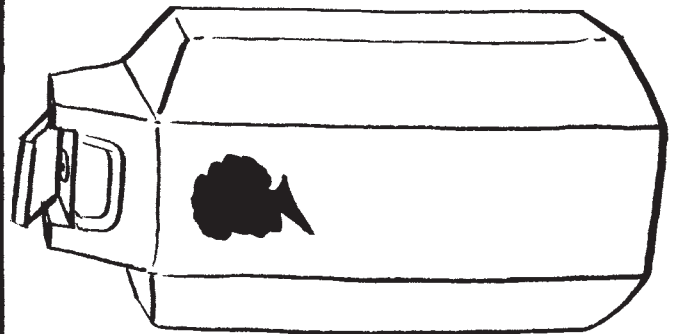
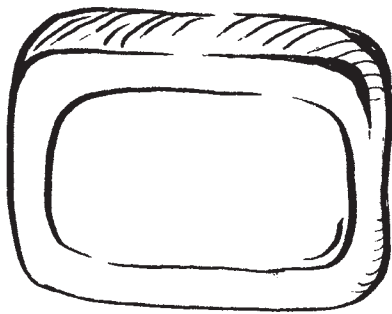
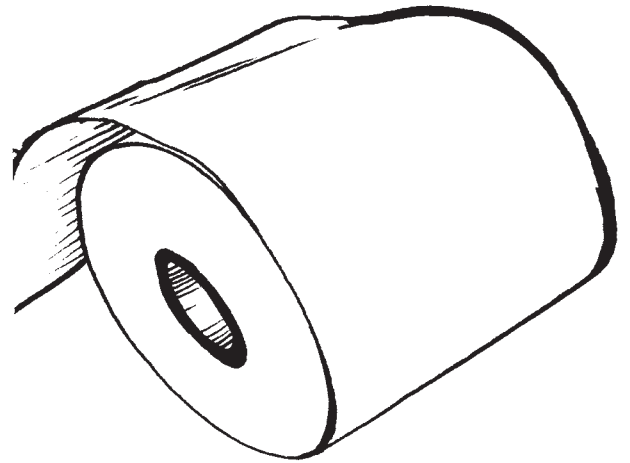
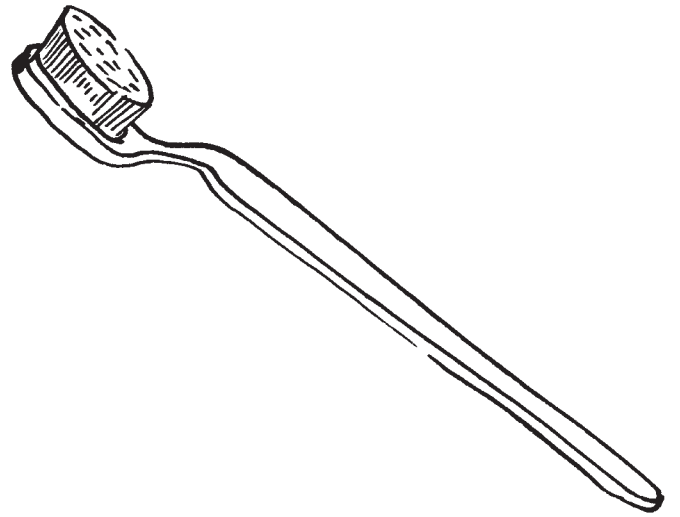
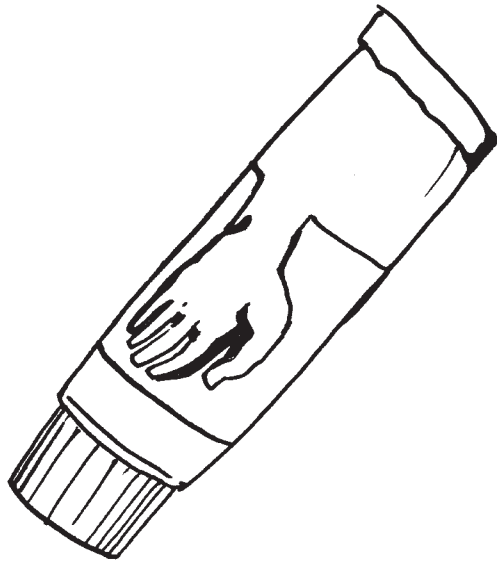

KRÉM  
NA  
RUCE

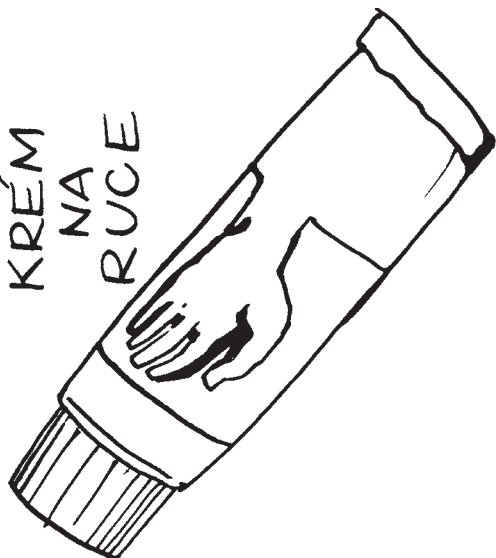

KARTÁČEK  
(NA ZUBY)

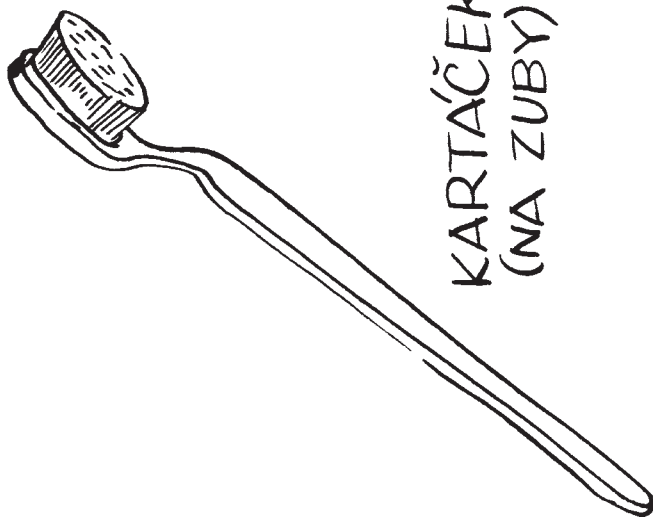

KRÉM  
NA  
HOLENÍ



TOALETNÍ  
PAPÍR

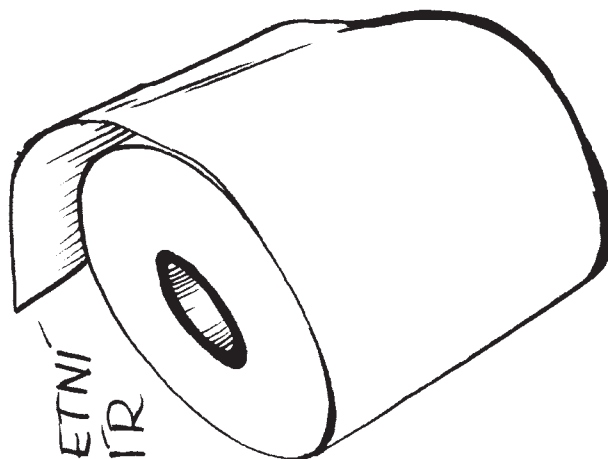

MÝDLO

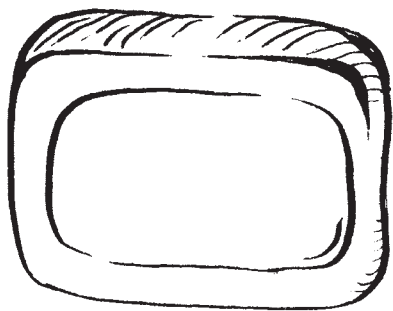

ŠAMPON

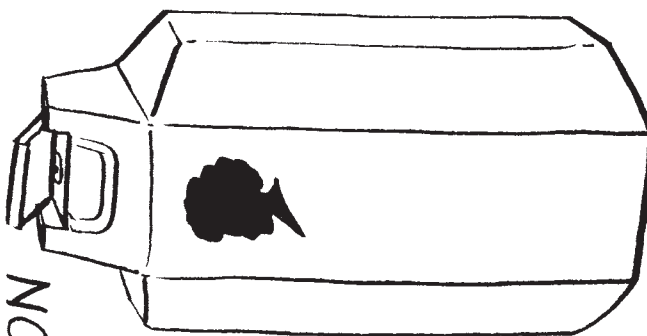

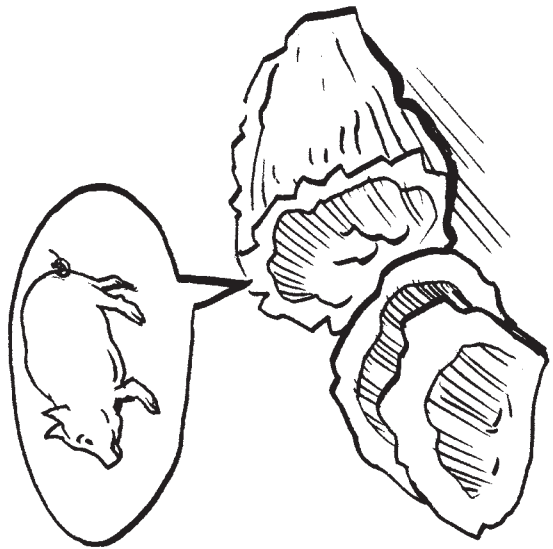
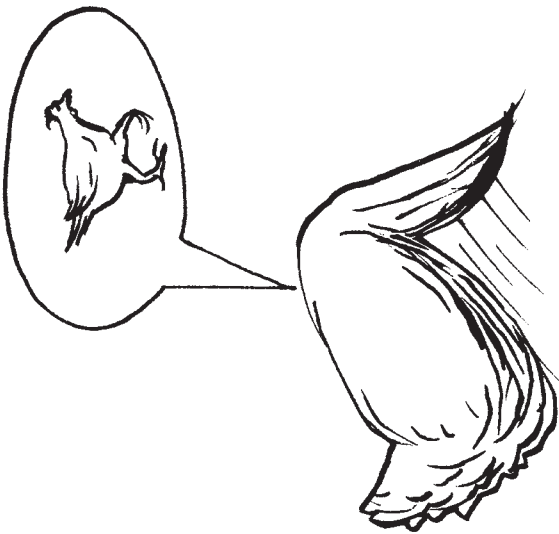
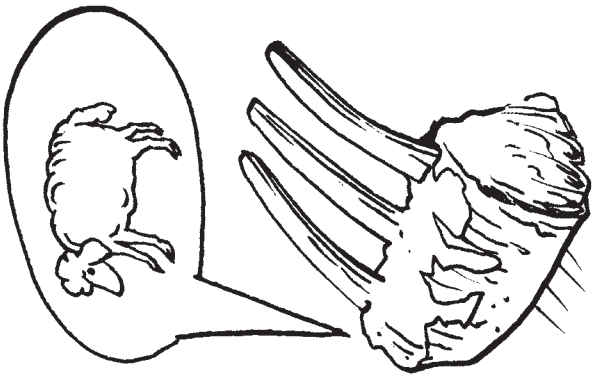
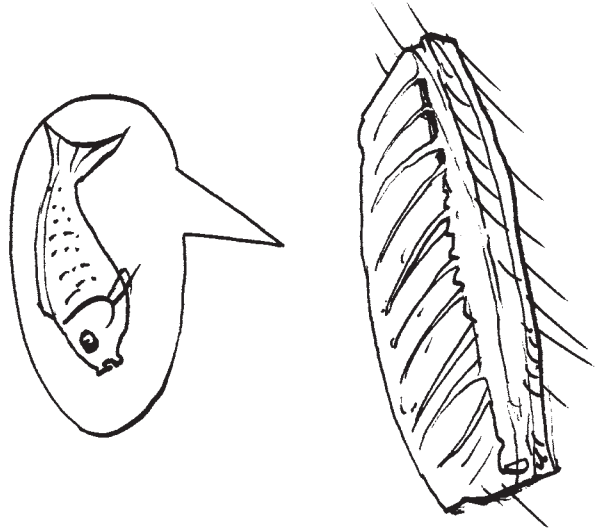
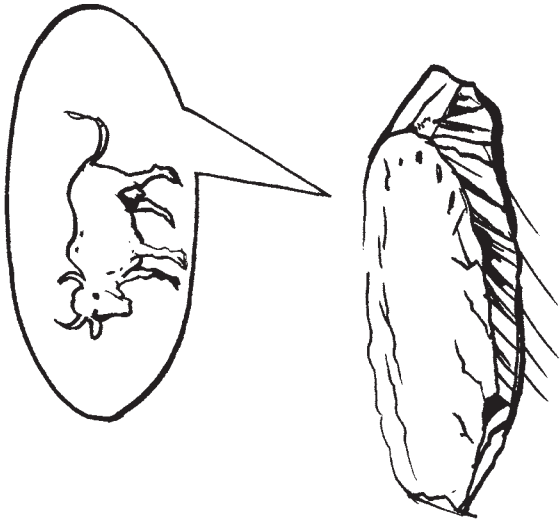

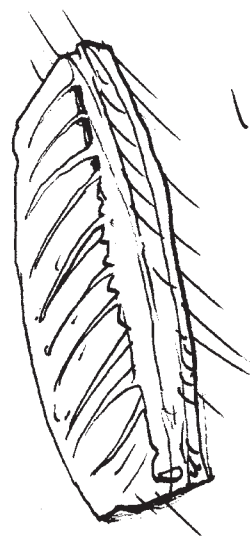
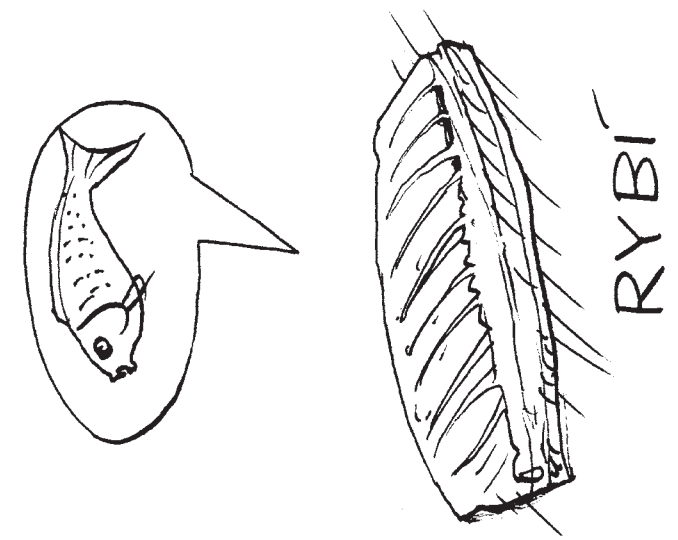
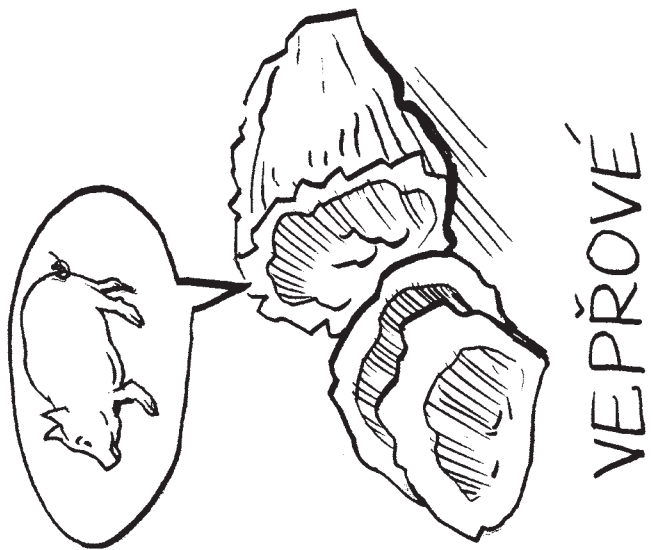
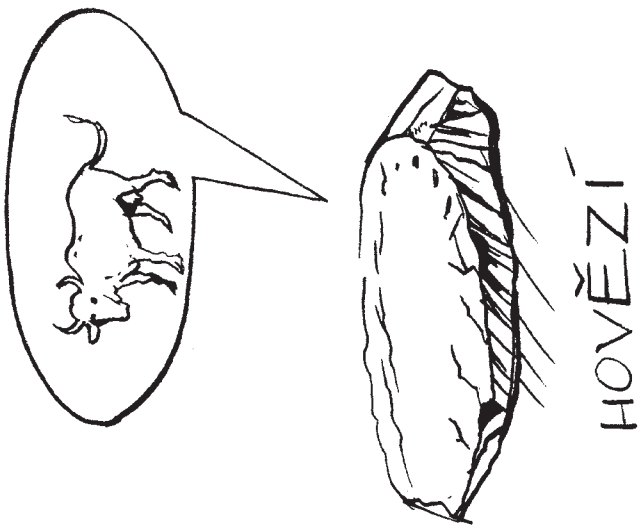
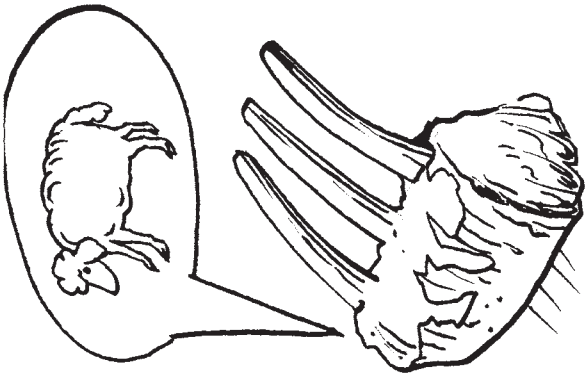
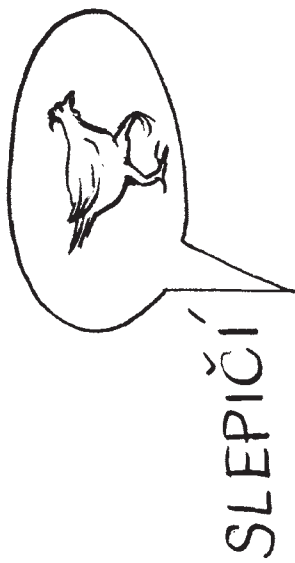



20,-



13,-

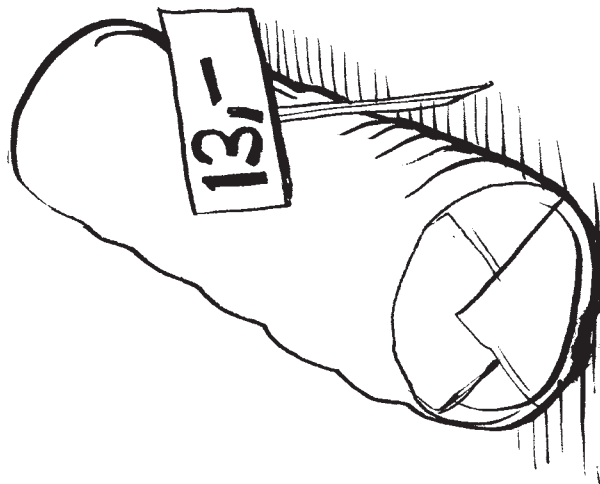

1,50

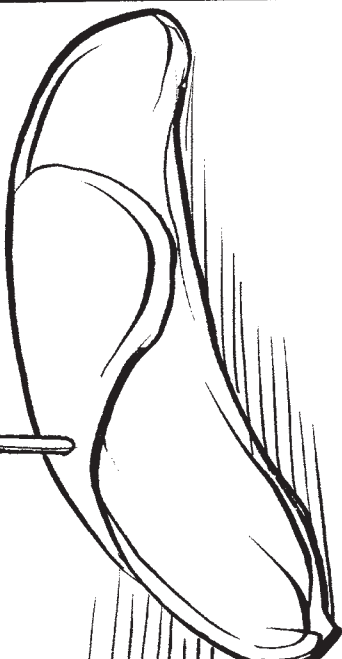

30,-

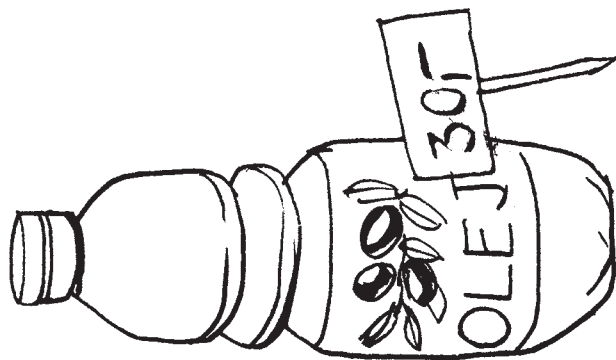

28,-



12,90



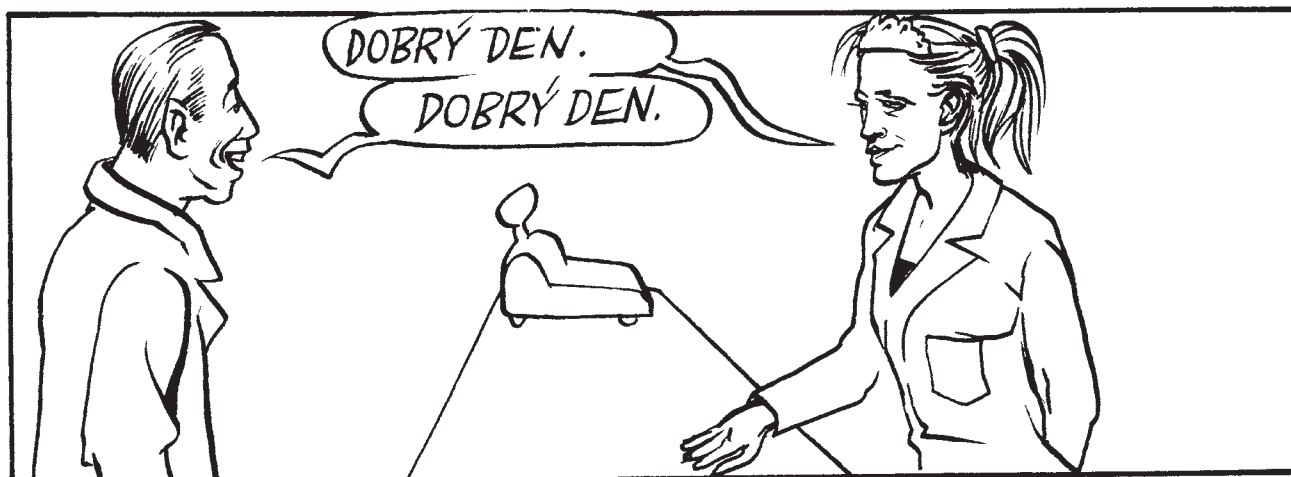

<p><b>1</b></p> <hr/> <p>•</p> <hr/> <p><i>jedna</i></p>	<p><b>2</b></p> <hr/> <p>••</p> <hr/> <p><i>dvě</i></p>	<p><b>3</b></p> <hr/> <p>•••</p> <hr/> <p><i>tři</i></p>	<p><b>4</b></p> <hr/> <p>••••</p> <hr/> <p><i>čtyři</i></p>
<p><b>5</b></p> <hr/> <p>•••••</p> <hr/> <p><i>pět</i></p>	<p><b>6</b></p> <hr/> <p>••••••</p> <hr/> <p><i>šest</i></p>	<p><b>7</b></p> <hr/> <p>•••••••</p> <hr/> <p><i>sedm</i></p>	<p><b>8</b></p> <hr/> <p>••••••••</p> <hr/> <p><i>osm</i></p>
<p><b>9</b></p> <hr/> <p>••••••••</p> <hr/> <p><i>devět</i></p>	<p><b>10</b></p> <hr/> <p>••••••••••</p> <hr/> <p><i>deset</i></p>	<p><b>11</b></p> <hr/> <p></p> <hr/> <p><i>jedenáct</i></p>	<p><b>12</b></p> <hr/> <p></p> <hr/> <p><i>dvanáct.</i></p>
<p><b>13</b></p> <hr/> <p><i>třináct</i></p>	<p><b>14</b></p> <hr/> <p><i>čtrnáct</i></p>	<p><b>15</b></p> <hr/> <p><i>patnáct</i></p>	<p><b>16</b></p> <hr/> <p><i>šestnáct</i></p>
<p><b>17</b></p> <hr/> <p><i>sedmnáct</i></p>	<p><b>18</b></p> <hr/> <p><i>osmnáct</i></p>	<p><b>19</b></p> <hr/> <p><i>devatenáct</i></p>	<p><b>20</b></p> <hr/> <p><i>dvacet</i></p>

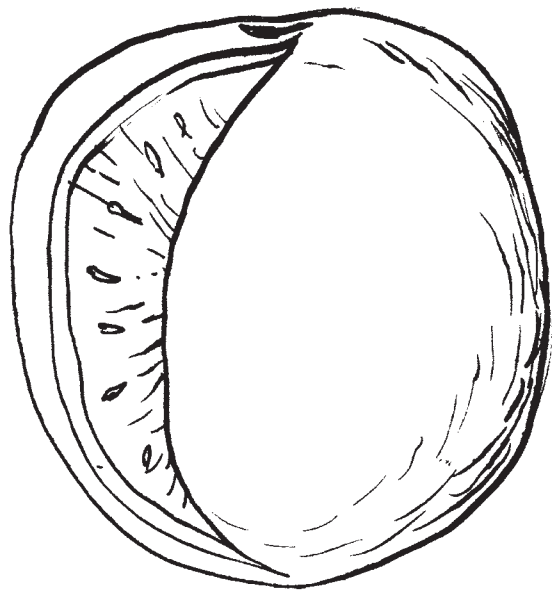
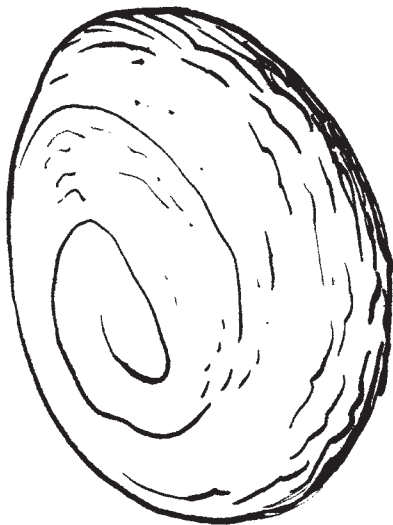
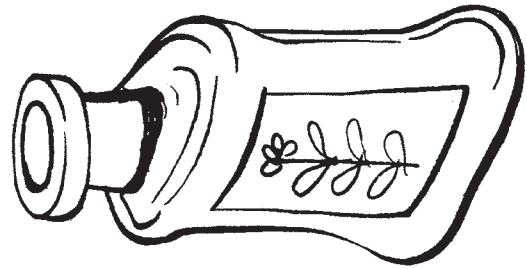
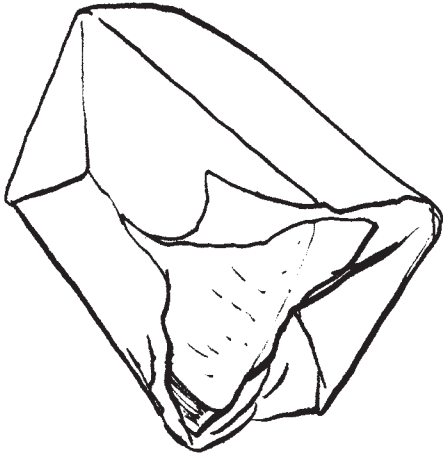

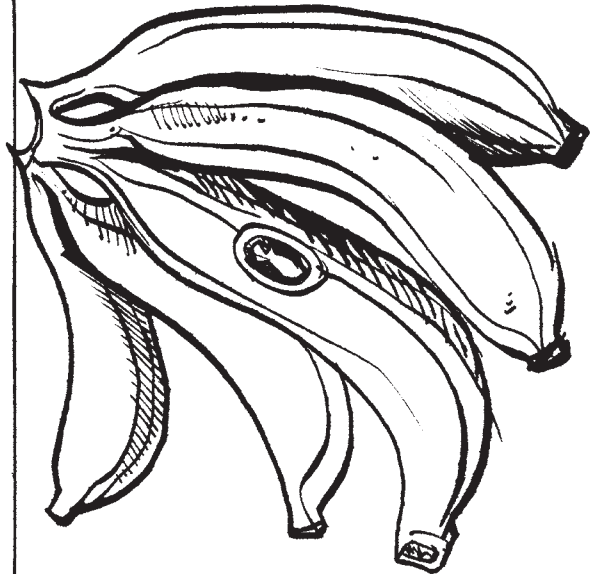
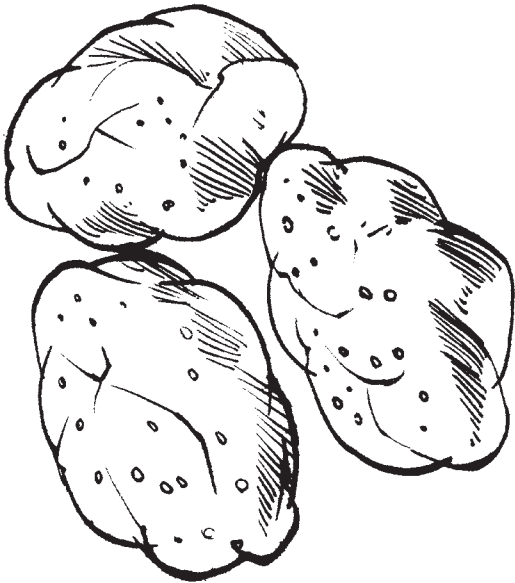
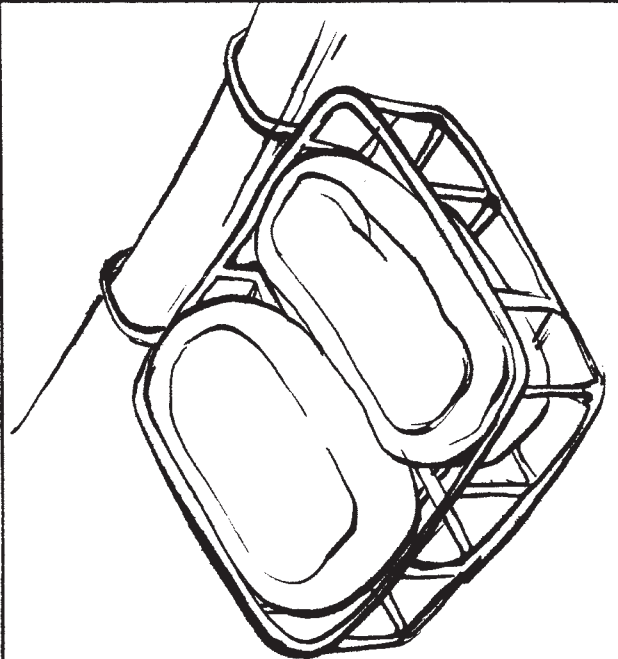
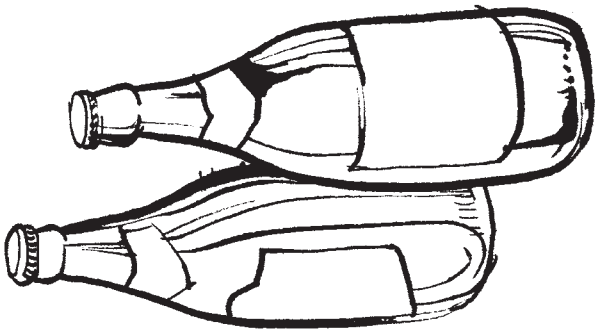
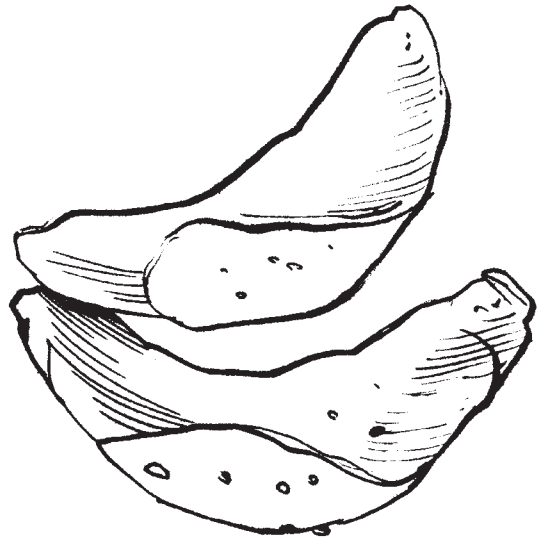
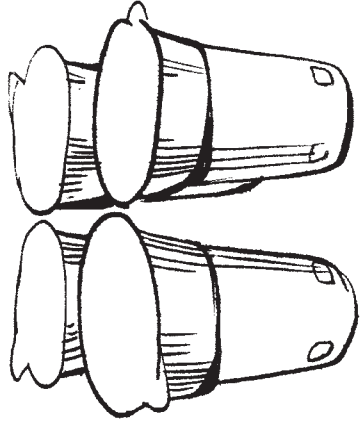

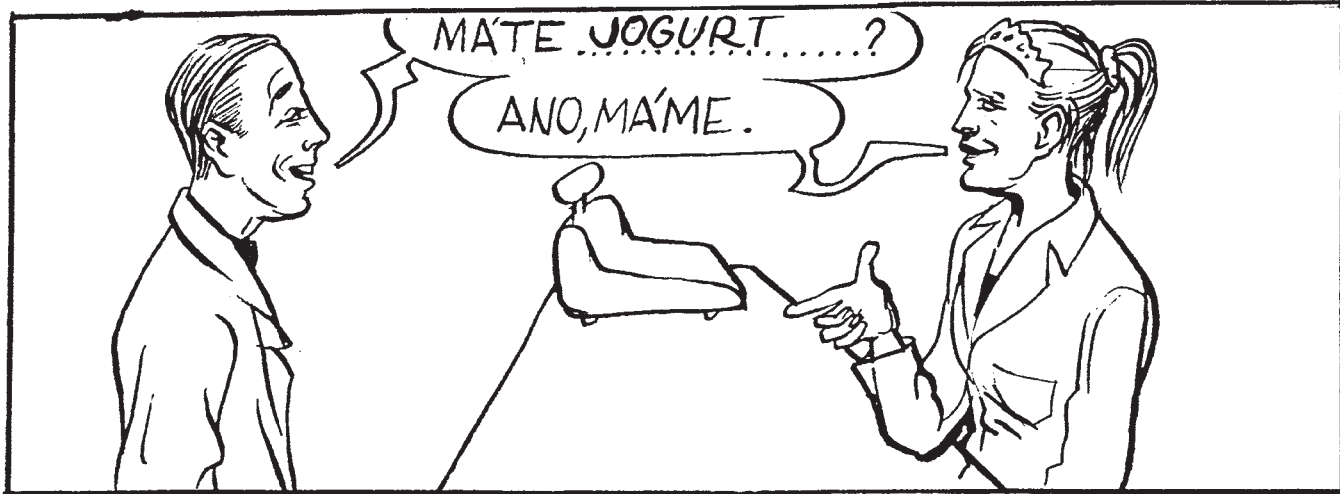

30

třicet

40

čtyřicet

50

padesát

60

šedesát

70

sedmdesát

80

osmdesát

90

devadesát

100

sto

200

dvěstě

300

třista

400

čtyřista

500

pětset

600

šestset

700

sedmset

800

osmset

900

devětset

1000

tisíc



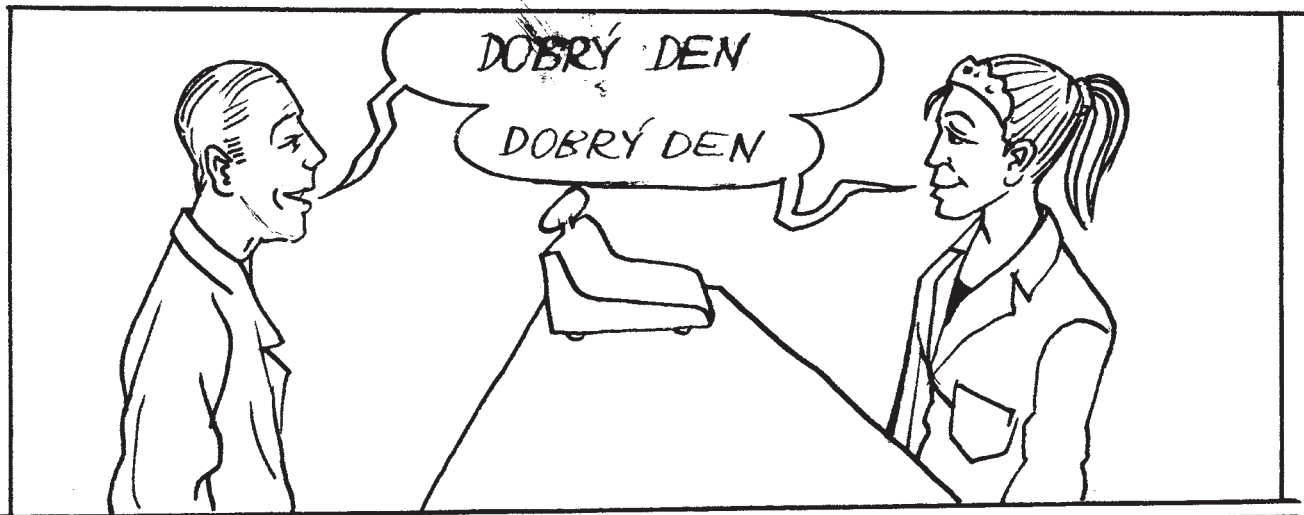



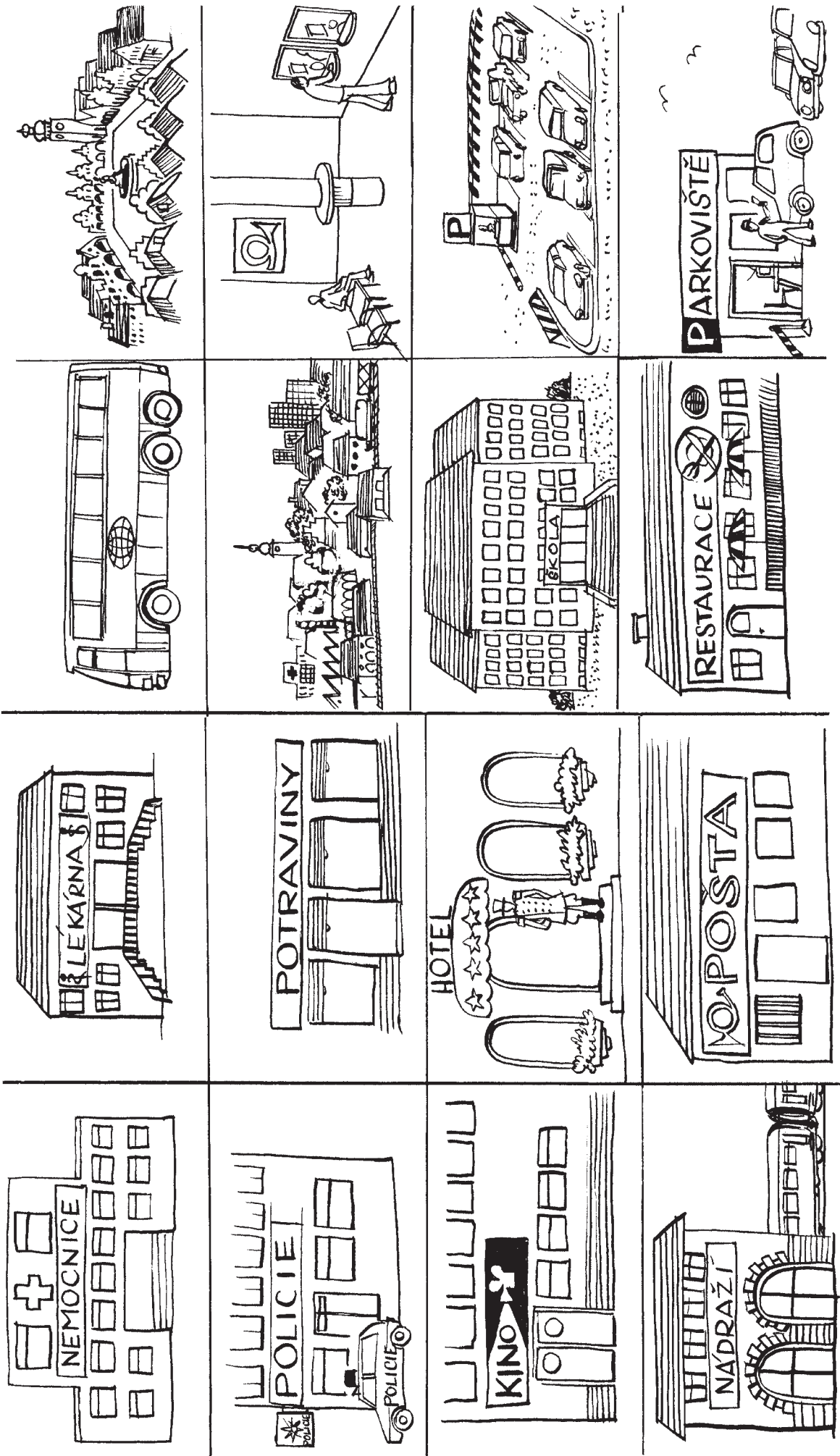

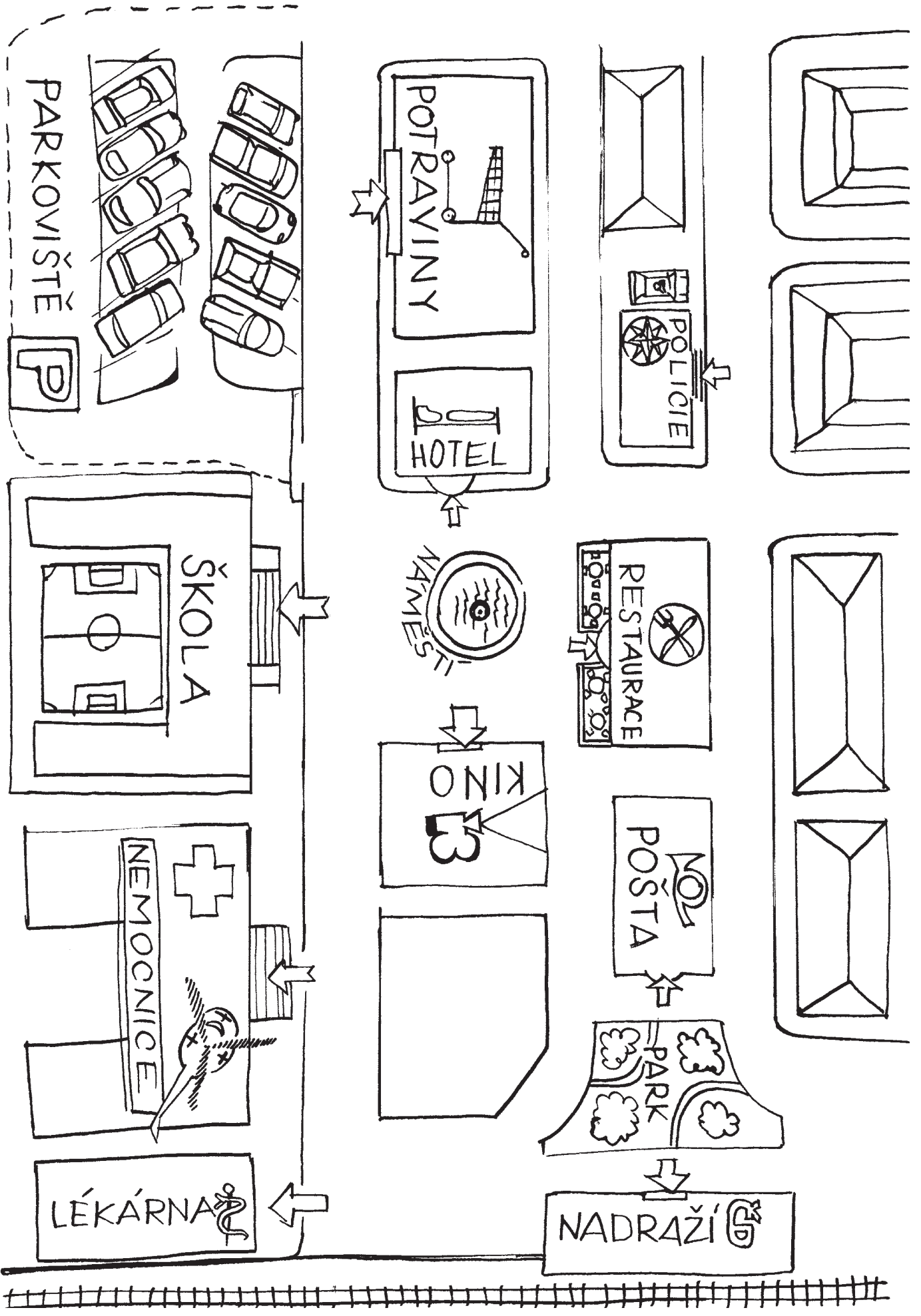

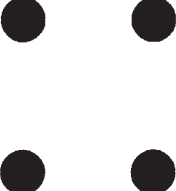
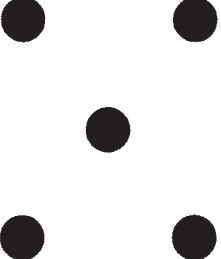
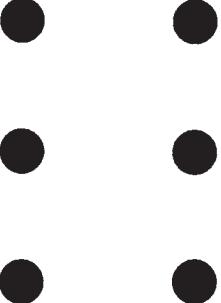
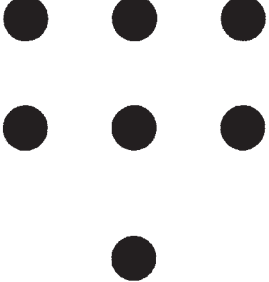
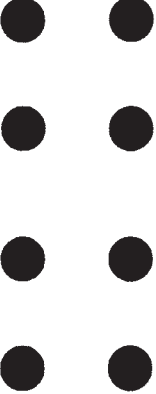
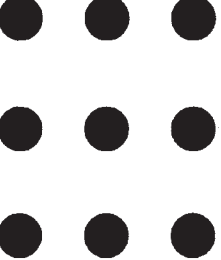

1	2	3
4	5	6
7	8	9

30

třicet

40

čtyřicet

50

padesát

60

šedesát

70

sedmdesát

80

osmdesát

90

devadesát

100

sto

200

dvěstě

300

třista

400

čtyřista

500

pětset

600

šestset

700

sedmset

800

osmset

900

devětset

1000

tisíc

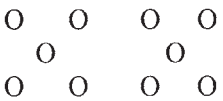
<p><b>10</b></p>  <p>deset</p>	<p><b>11</b></p> <p>jedenáct</p>	<p><b>12</b></p> <p>dvanáct</p>
<p><b>13</b></p> <p>třináct</p>	<p><b>14</b></p> <p>čtrnáct</p>	<p><b>15</b></p> <p>patnáct</p>
<p><b>16</b></p> <p>šestnáct</p>	<p><b>17</b></p> <p>sedmnáct</p>	<p><b>18</b></p> <p>osmnáct</p>

10	11	12
13	14	15
16	17	18

<b>19</b> devatenáct	<b>20</b> dvacet	<b>21</b> dvacet jedna
-------------------------	---------------------	------------------------------

<b>20</b> dvacet	<b>30</b> třicet	<b>40</b> čtyřicet
<b>50</b> padesát	<b>60</b> šedesát	<b>70</b> sedmdesát
<b>80</b> osmdesát	<b>90</b> devadesát	<b>100</b> sto



19	20	30
40	50	60
70	80	90

100	21	32
43	54	65
76	87	98

1	JEDNA	11	JEDENÁCT
2	DVĚ	12	DVANÁCT
3	TŘI	13	TŘINÁCT
4	ČTYŘI	14	ČTRNÁCT
5	PĚT	15	PATNÁCT
6	ŠEST	16	ŠESTNÁCT
7	SEDM	17	SEDMNÁCT
8	OSM	18	OSMNÁCT
9	DEVĚT	19	DEVATENÁCT
10	DESET	20	DVACET

21	DVACET JEDNA
22	DVACET DVA
23	DVACET TŘI
24	DVACET ČTYŘI
25	DVACET PĚT
26	DVACET ŠEST
27	DVACET SEM
28	DVACET OSM
29	DVACET DEVĚT

1	jedna	11	jedenáct	21	dvacet jedna
2	dvě	12	dvanáct		
3	tři	13	třináct	30	třicet
4	čtyři	14	čtrnáct	40	čtyřicet
5	pět	15	patnáct	50	padesát
6	šest	16	šestnáct	60	šedesát
7	sedm	17	sedmnáct	70	sedmdesát
8	osm	18	osmnáct	80	osmdesát
9	devět	19	devatenáct	90	devadesát
10	deset	20	dvacet	100	sto

1:00	2:00
3:00	4:00
5:00	6:00
7:00	8:00
9:00	10:00
11:00	12:00

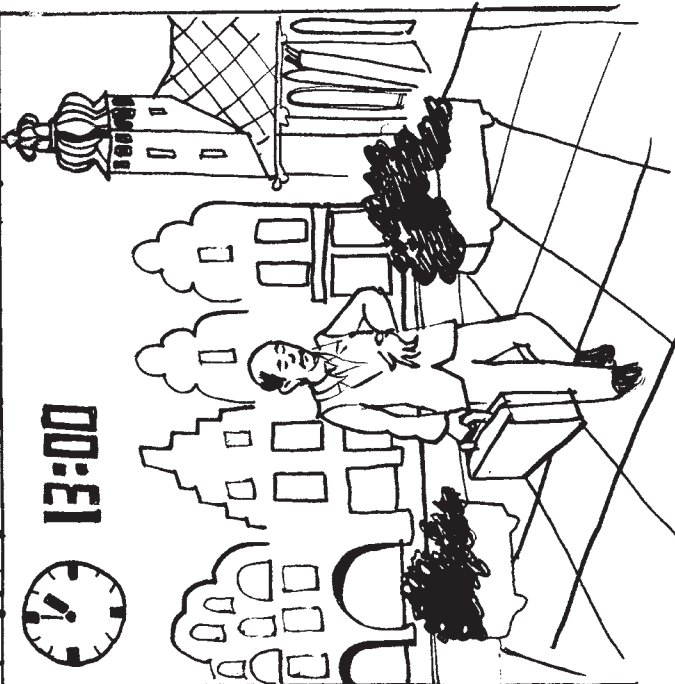
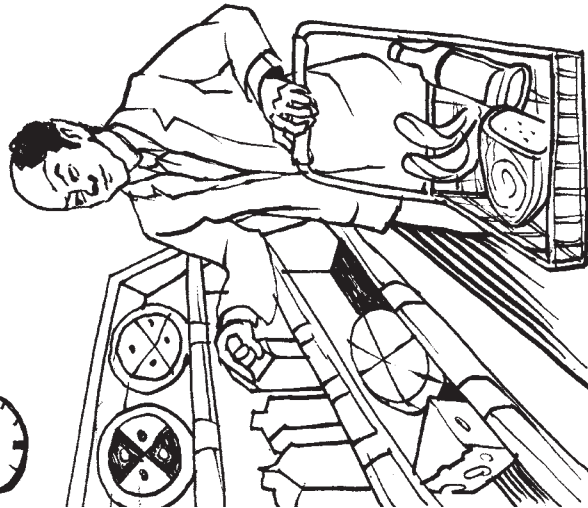
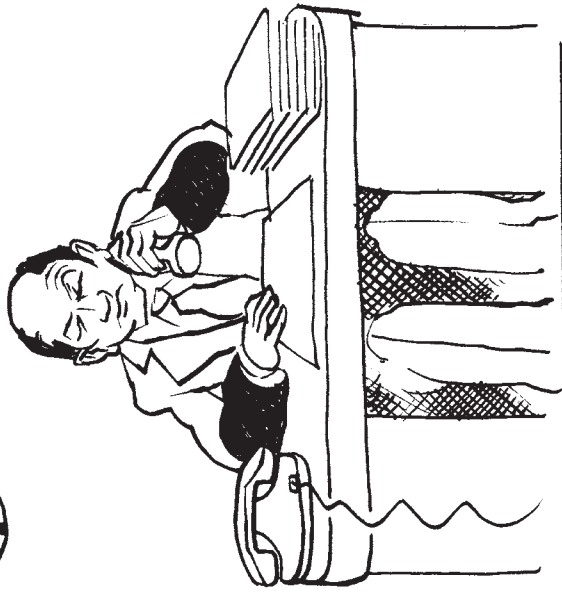
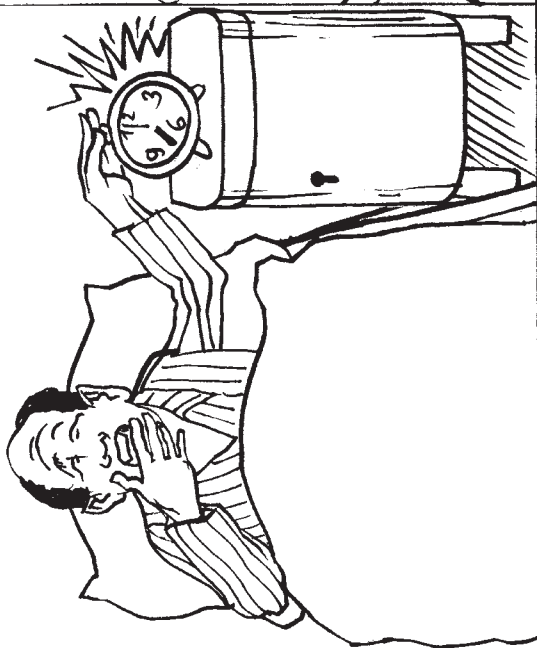



16:00



17:00

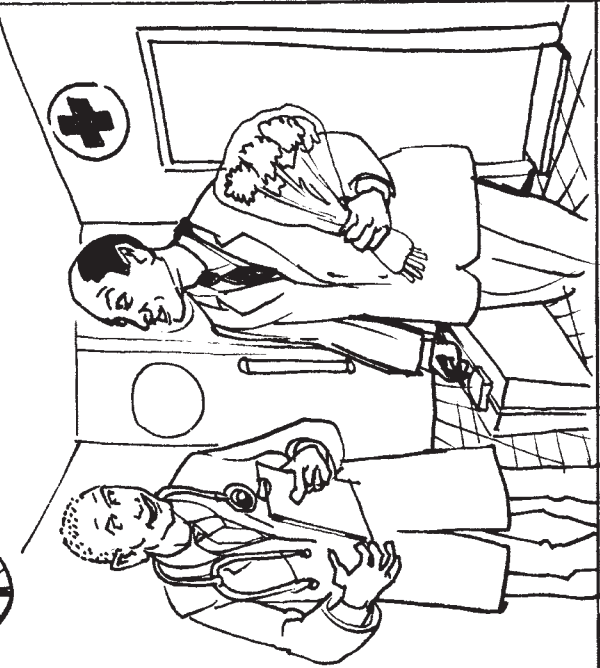

18:00

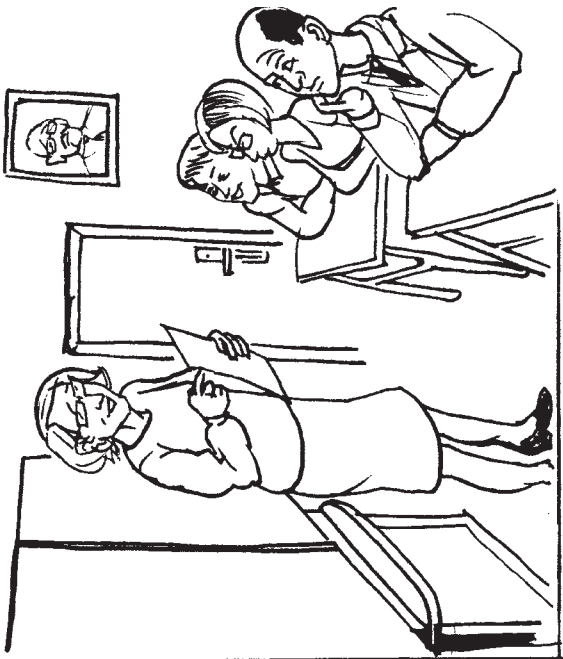

20:00

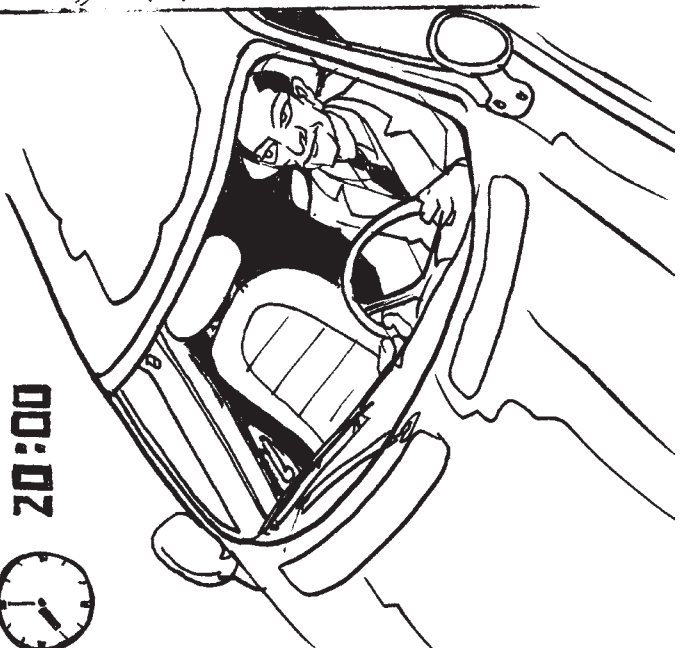

21:00

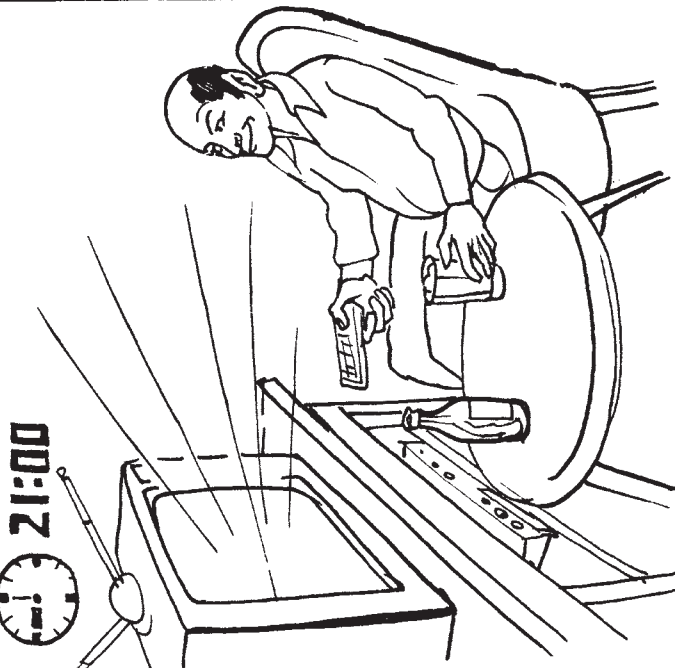

22:00

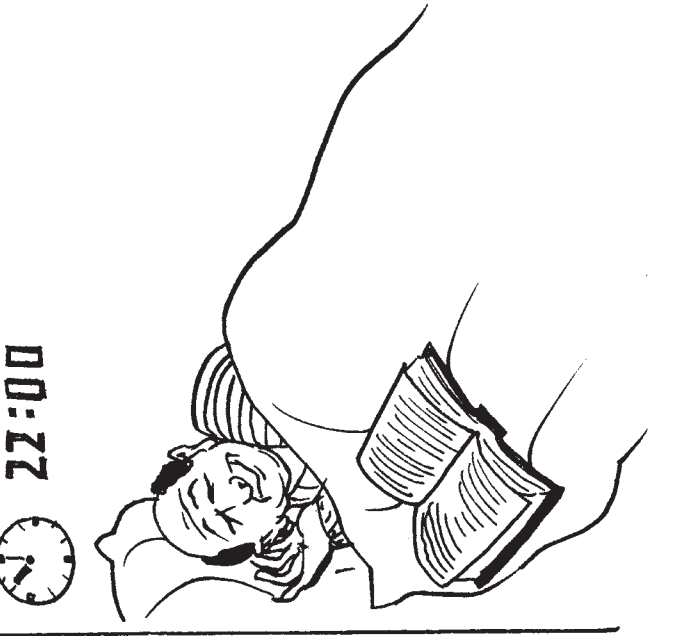

SNÍDANĚ

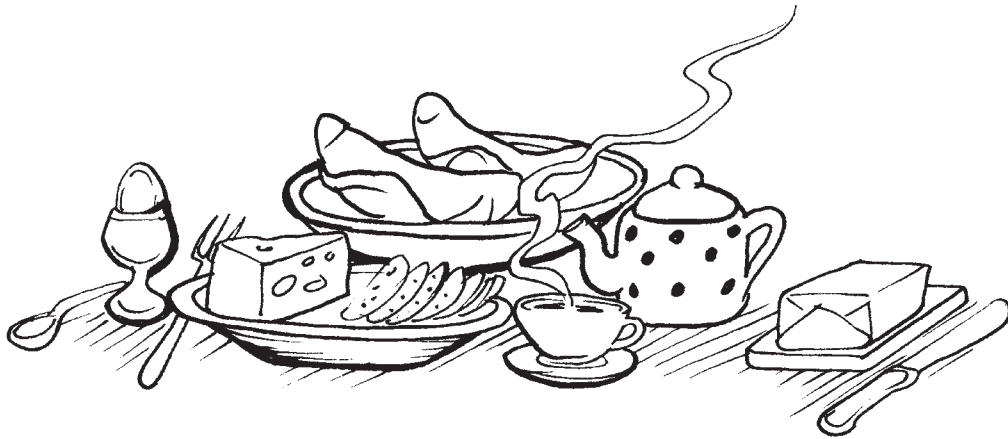

OBĚD



VEČEŘE

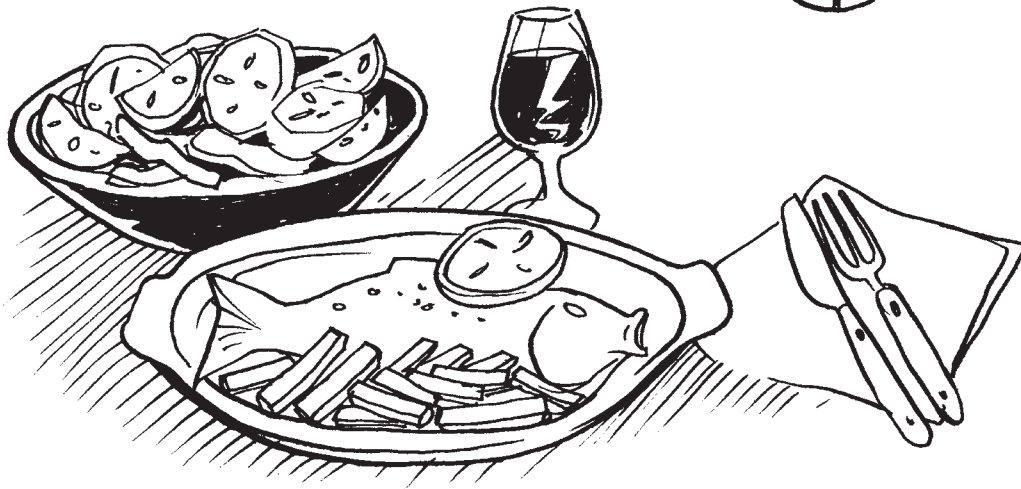
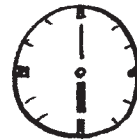



# OVOCE ZELEENINA

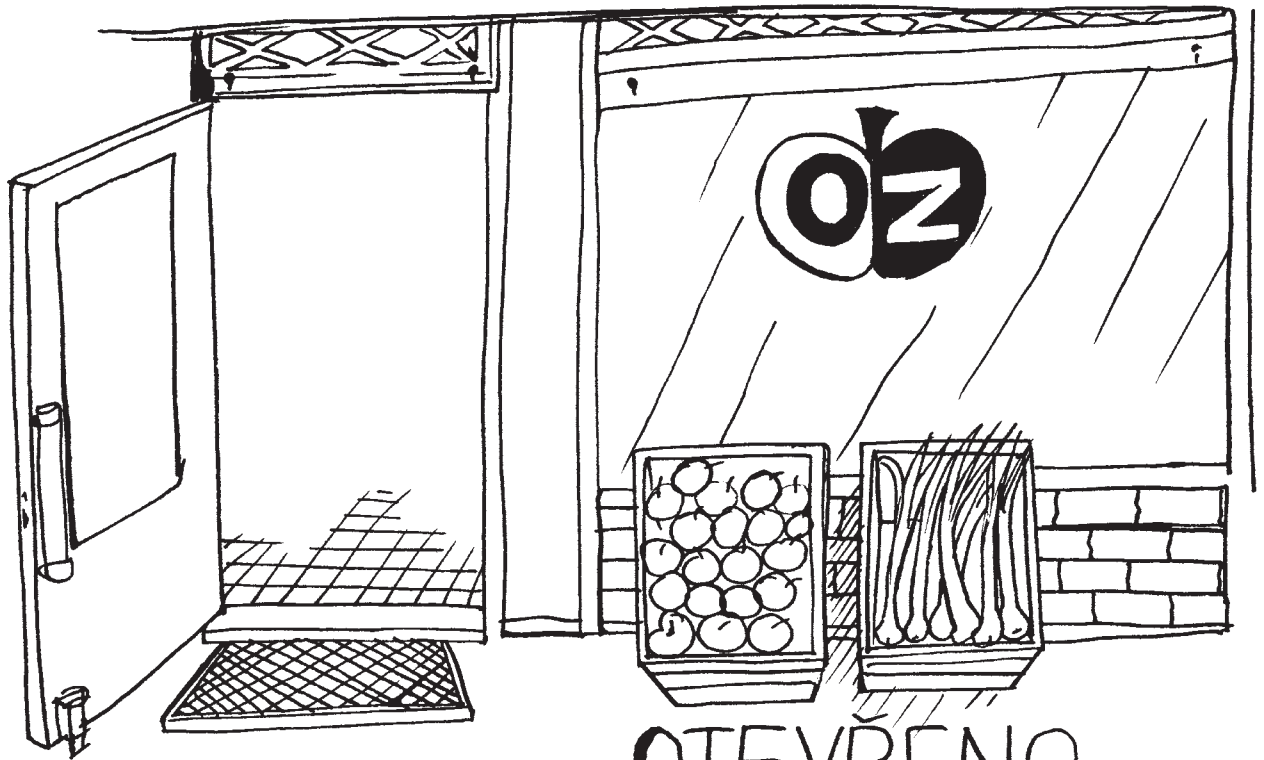

OTEVŘENO

# OVOCE ZELEENINA

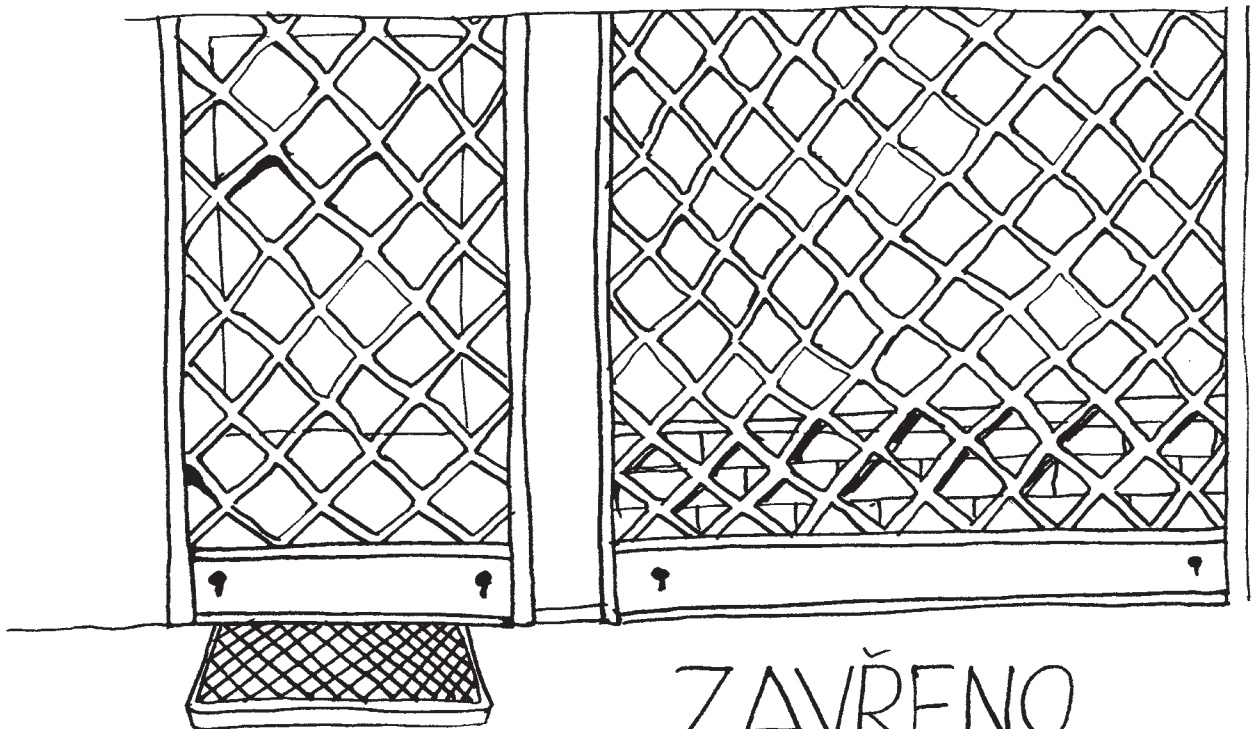

ZAVŘENO

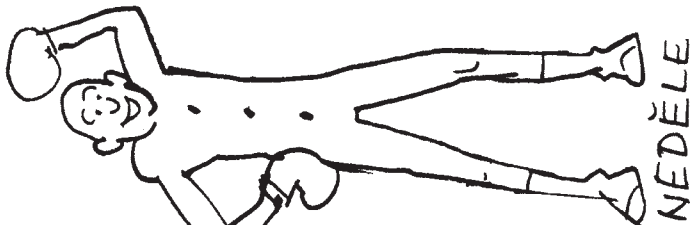

NEDELE

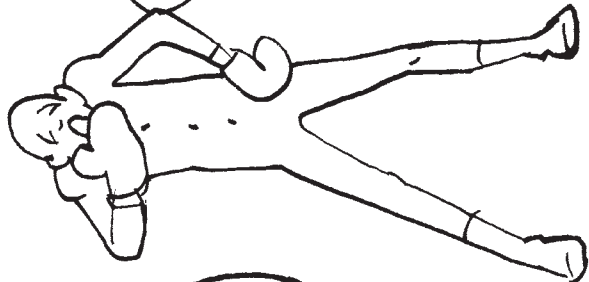

SOBOTA

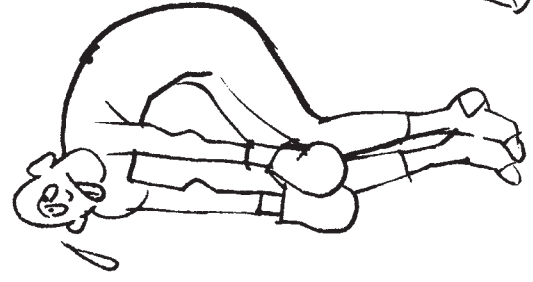

PATEK

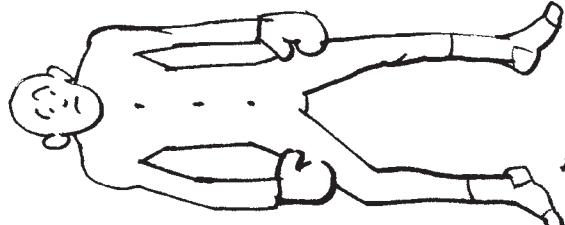

CTVRTEK

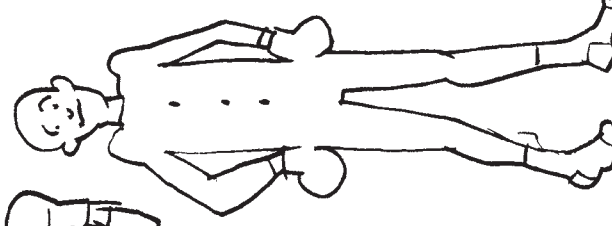

STREDA

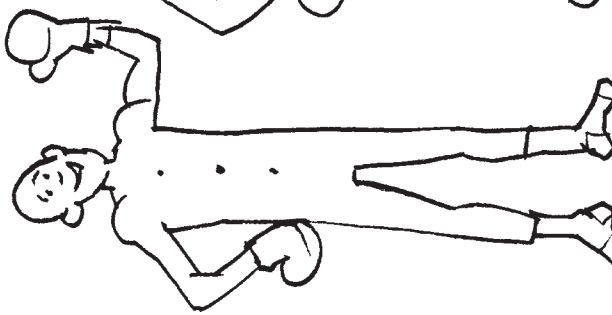

UTERY

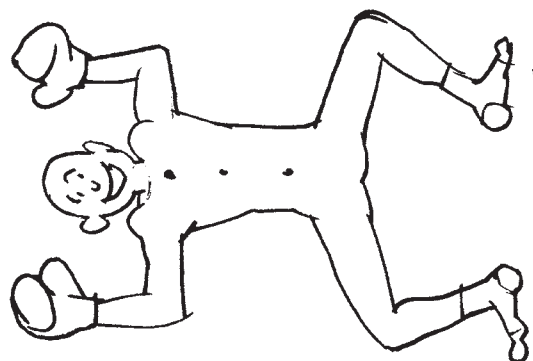

PONDĚLÍ

NE

V NEDELI

SO

V SOBOTU

PÁ

V PÁTEK

ČT

VE ČTVRTEK

ST

VE STŘEDU

ÚT

V ÚTERÝ

PO

V PONDĚLÍ

PO-

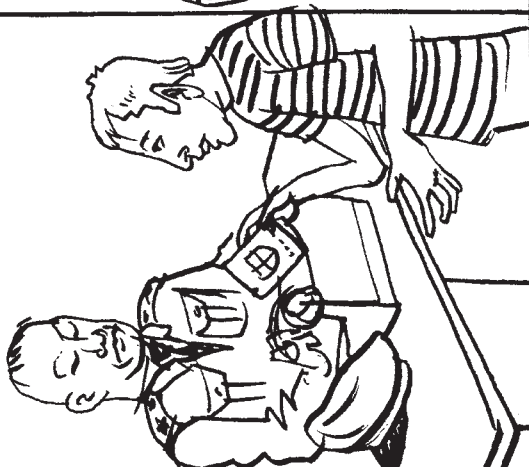

ÚT-



ST-

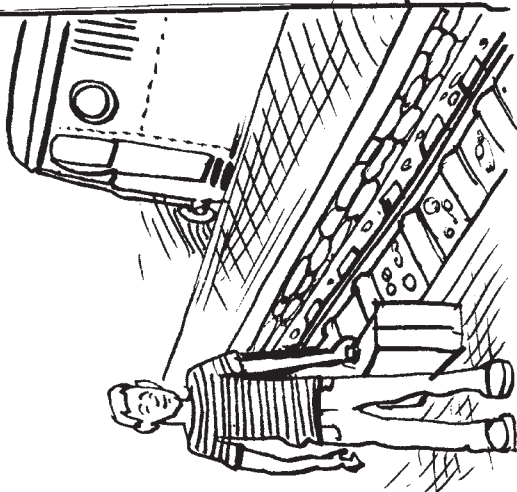

ČT-

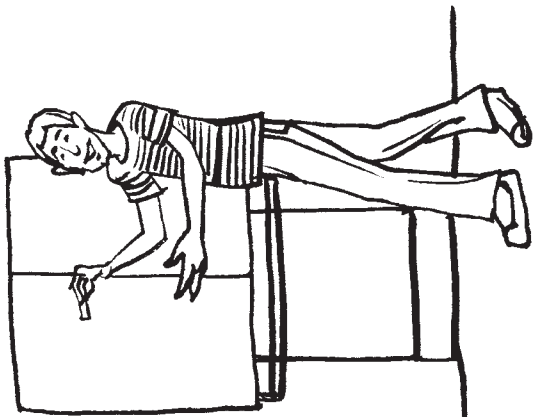

PA'-

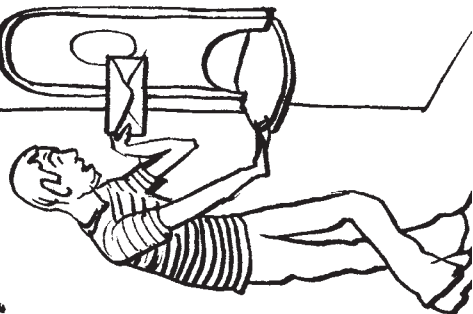



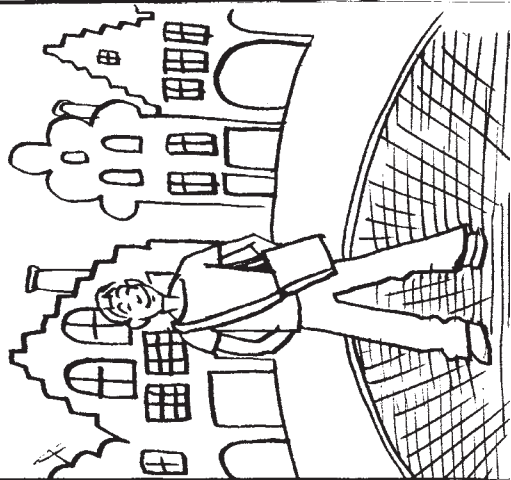



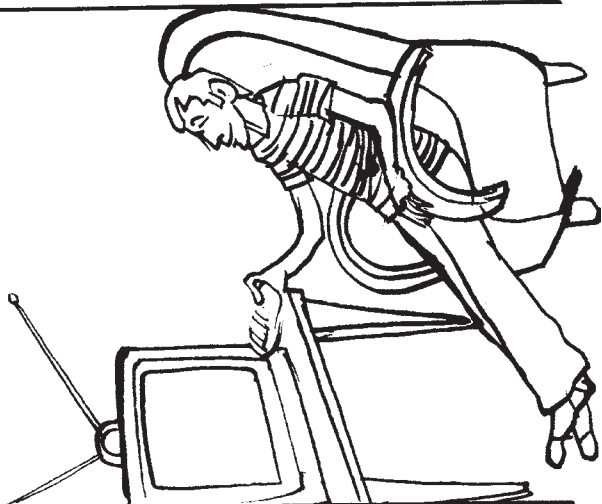





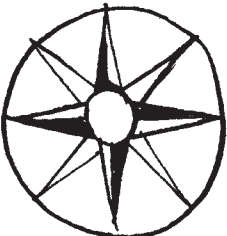
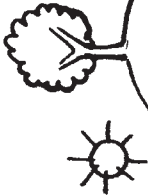



-SO-



NE-



 POŠTA PO, ST, PÁ 7 - 16	 POTRAVINY PO - PÁ 8 - 20	 NÁDRAŽÍ SO, NE 10 - 18	 NEMOCNICE ÚT: 7-12 ST: 12-16 PÁ: 7-13	 POLICIE ST, ČT 9 - 19	
RAŇNO  6 - 10	DOPOLEDNE   10 - 12	POLEDNE   12	ODPOLEDNE   12 - 17(5)	VEČER   17(5) - 23(11)	NOC    23(11) - 6

PO - 10:00

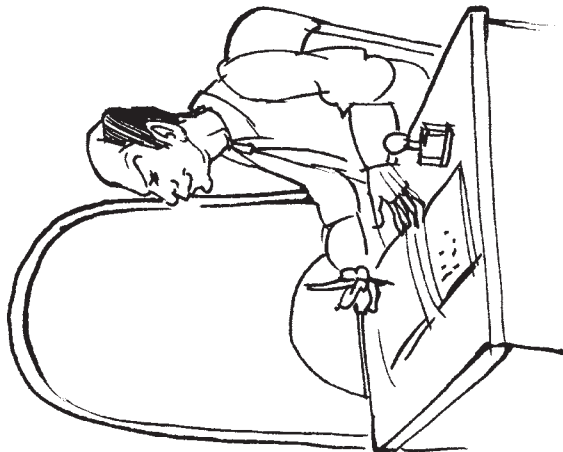

ÚT - 8:00

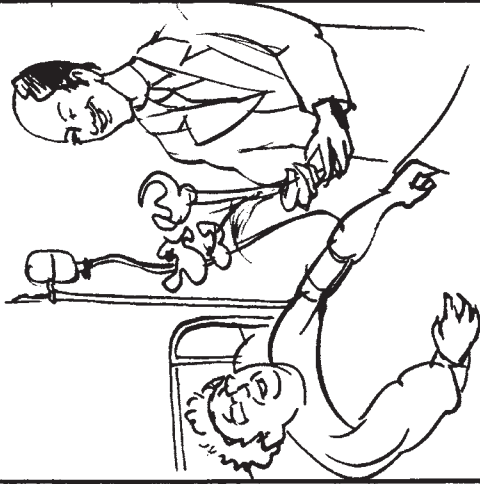

PA - 11:00

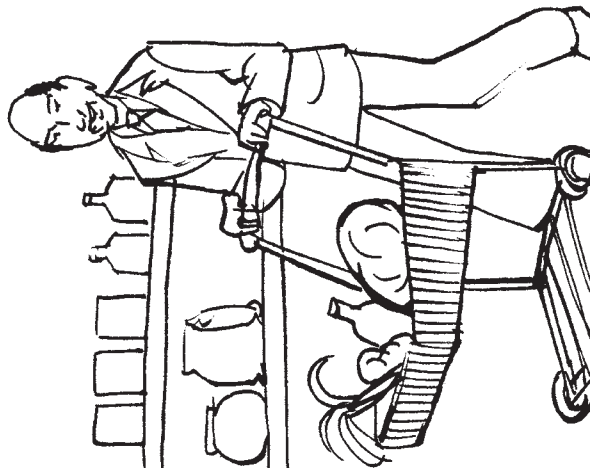

SO - 20:00



NE - 22:00

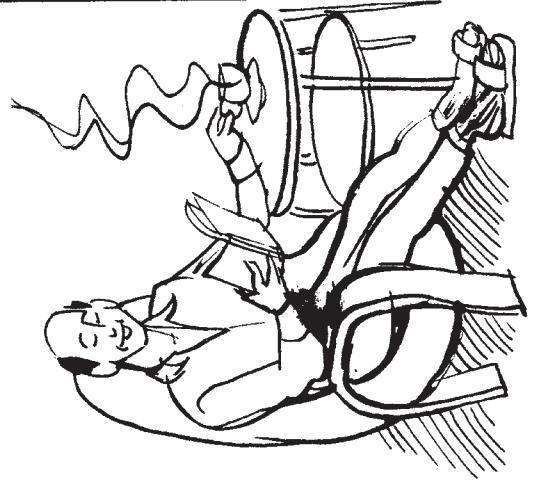

ST - 15:00

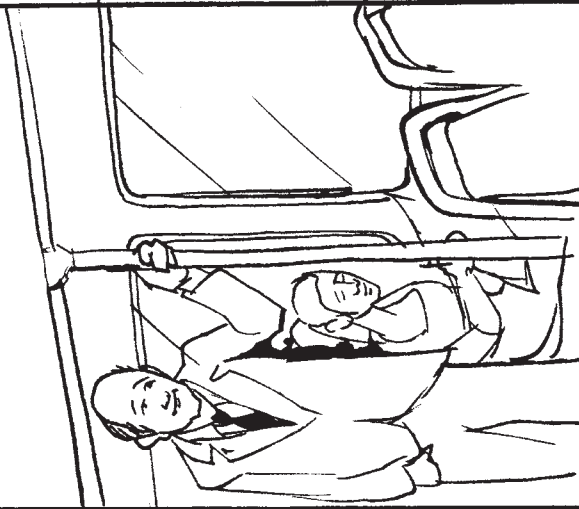

ČT - 17:00

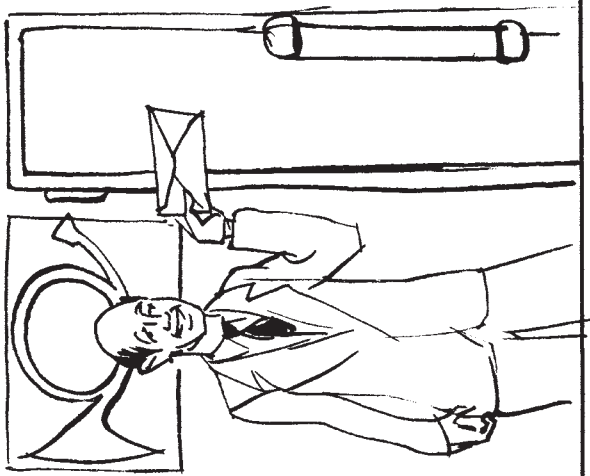



PO - 14:00

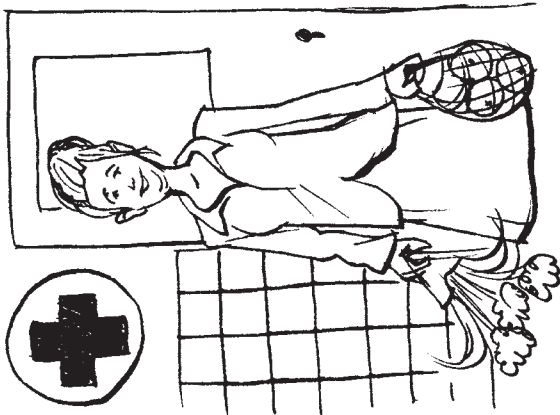

ÚT - 07:00

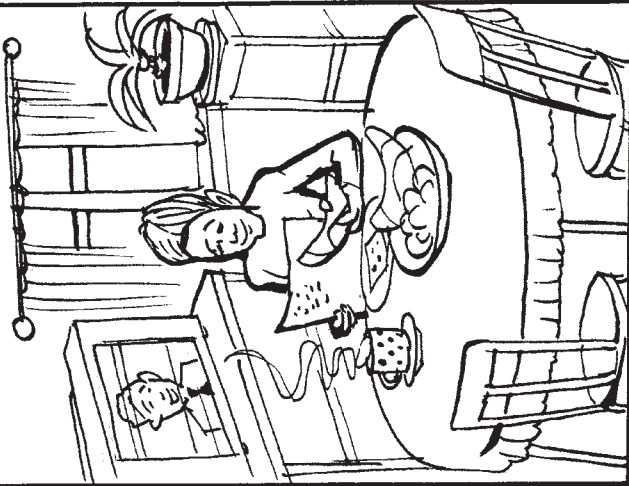

PA' - 21:00

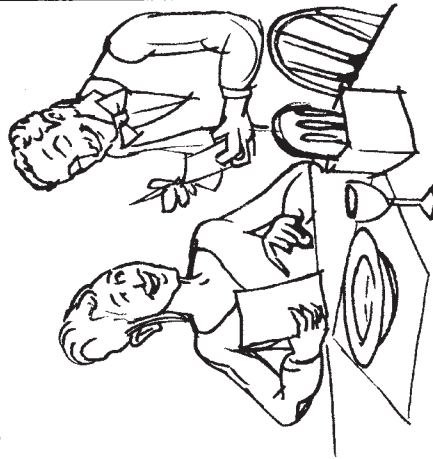

SO - 16:00



NE - 23:00

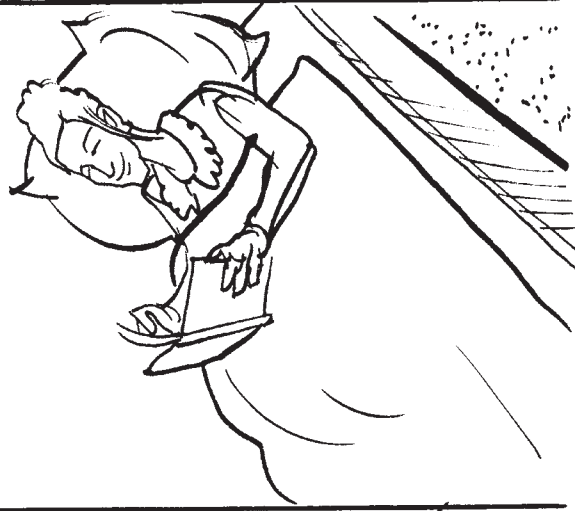

ST - 11:00

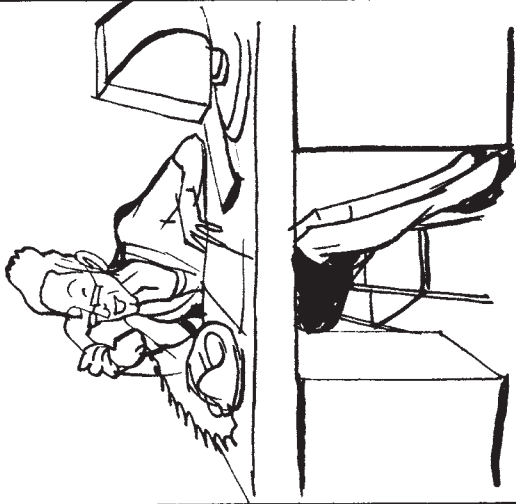

ČT - 17:00

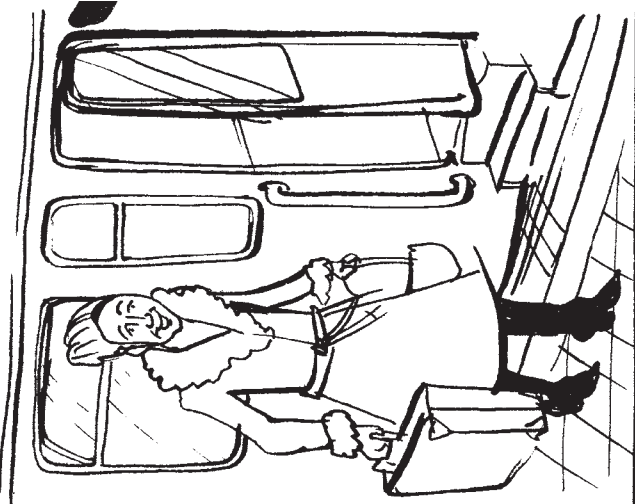

PO-11:00

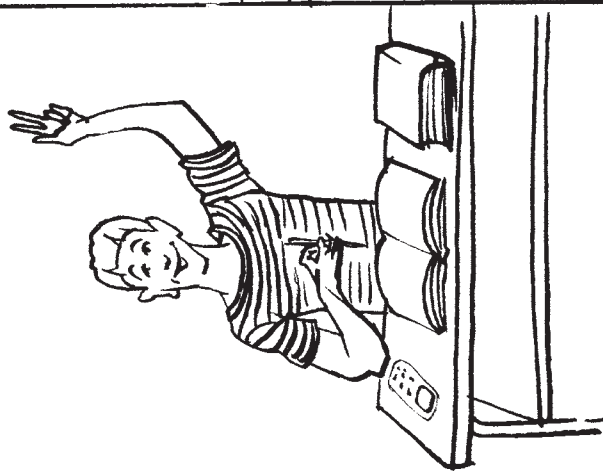

PA-20:00



UT-18:00

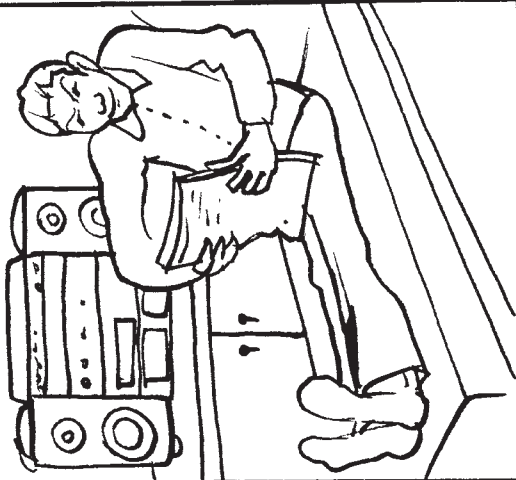

SO-21:00

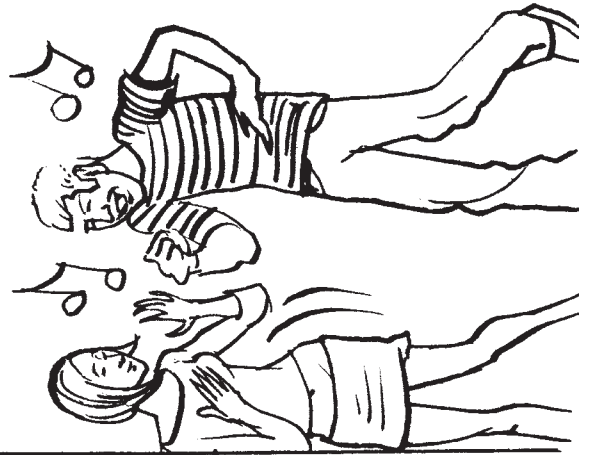

ST-16:00

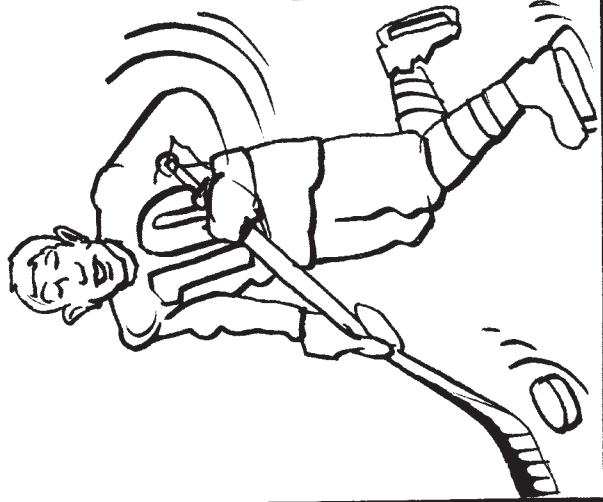

NE-08:00

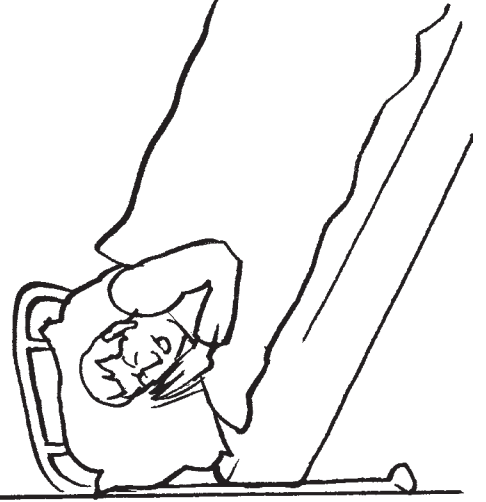

CT-09:00



PO- 18:00



ÚT- 09:00

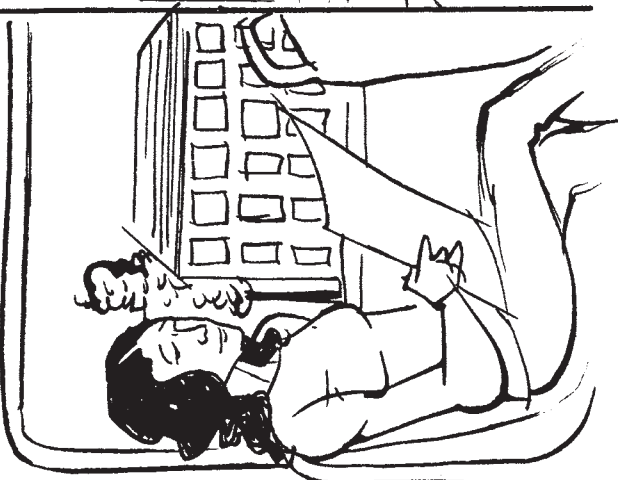

ST- 21:00



ČT- 11:00



PA' 23:00



SO-14:00

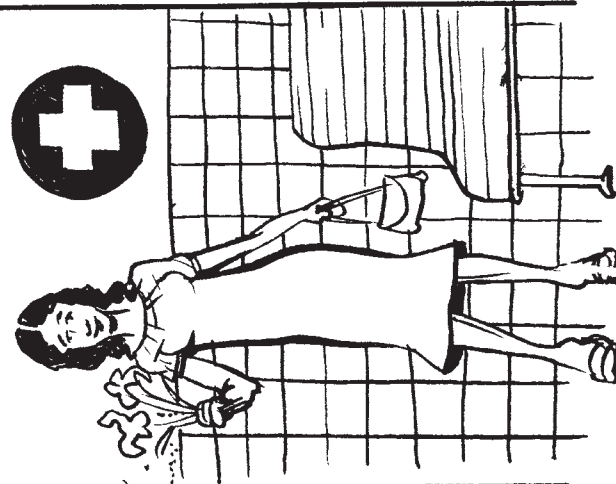

NE- 07:00





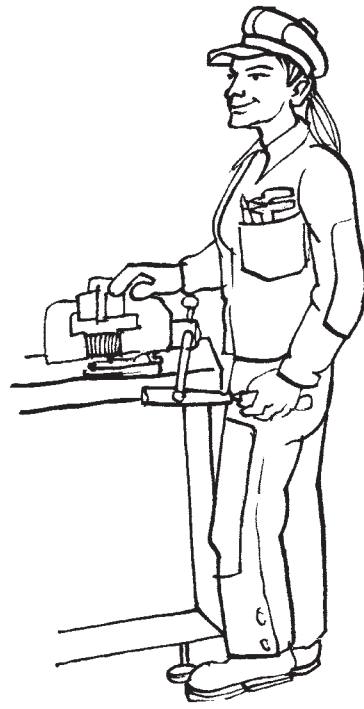
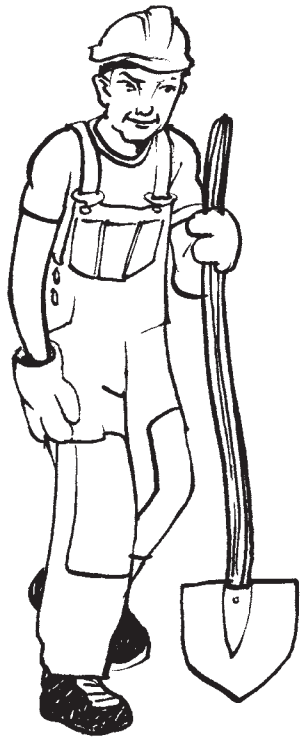

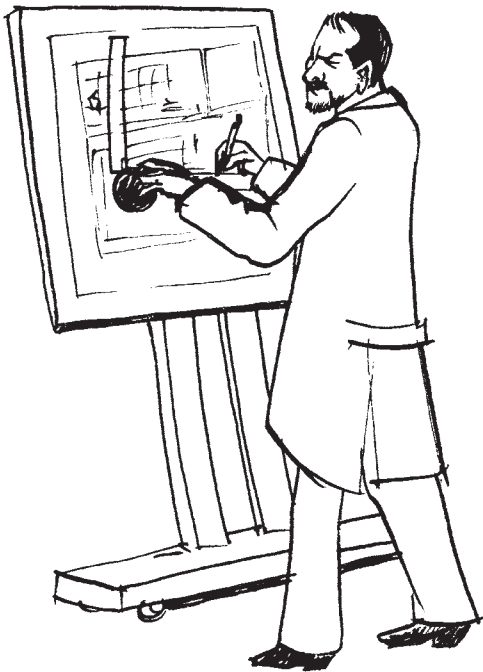
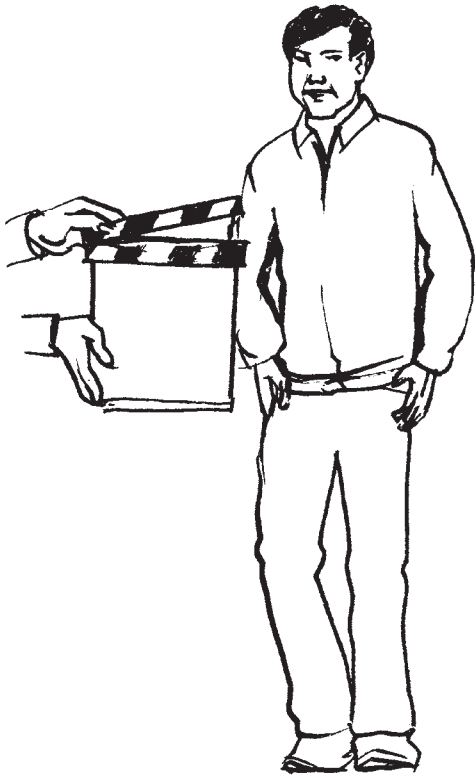



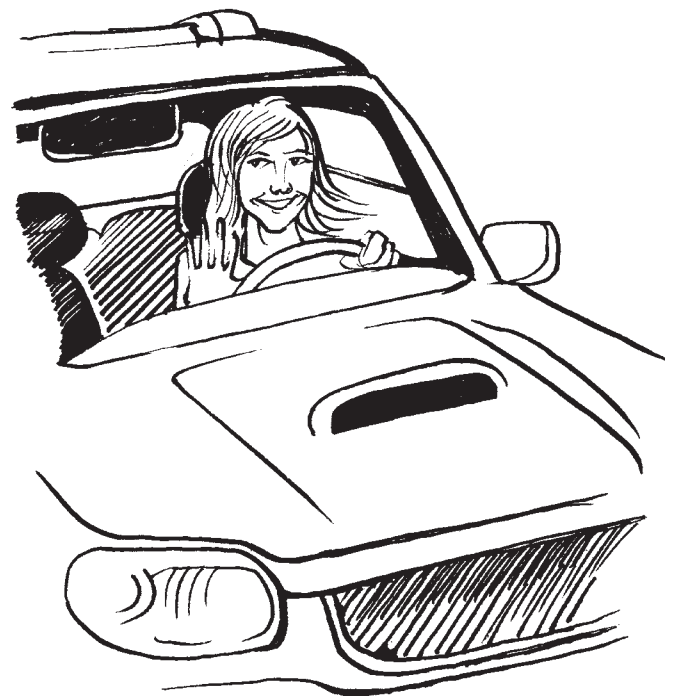
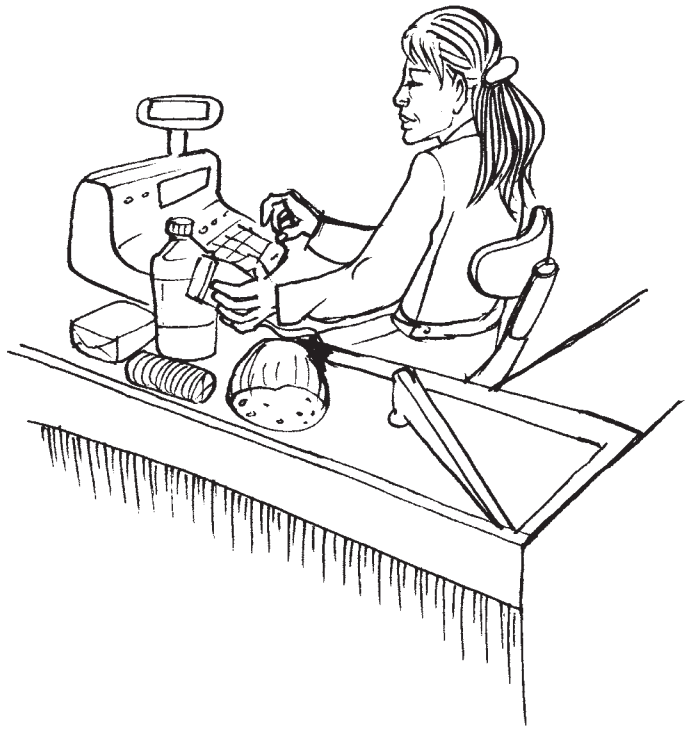



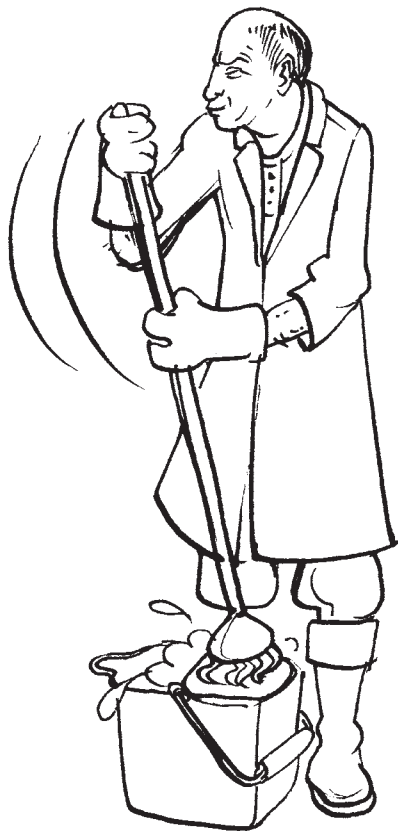
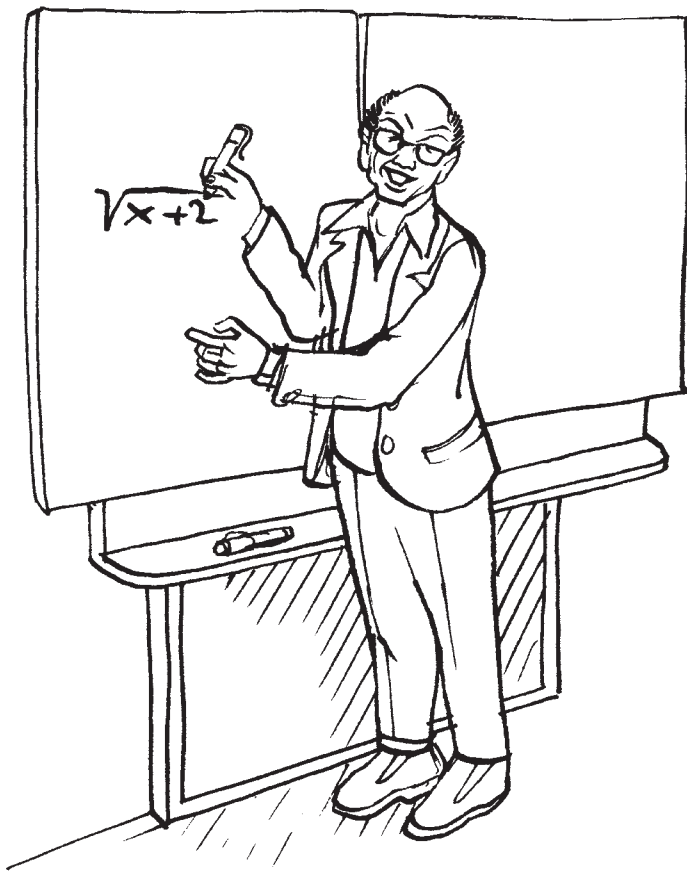











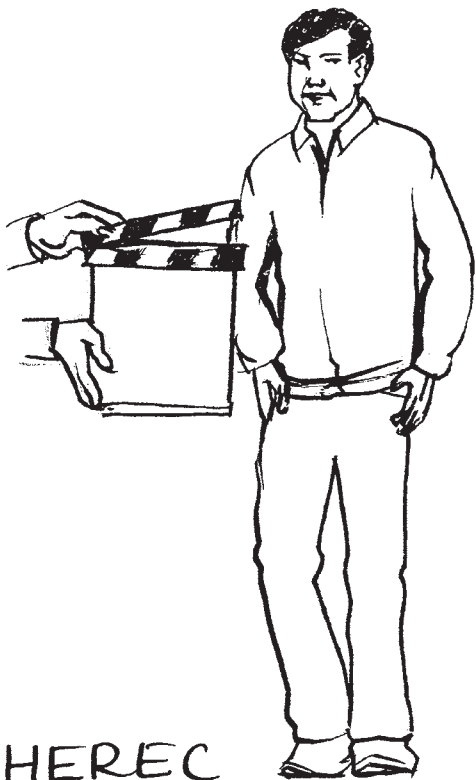

HEREC

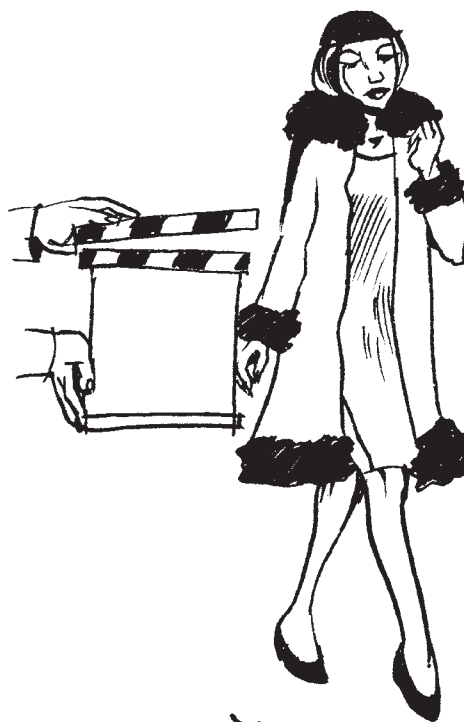

HEREČKA

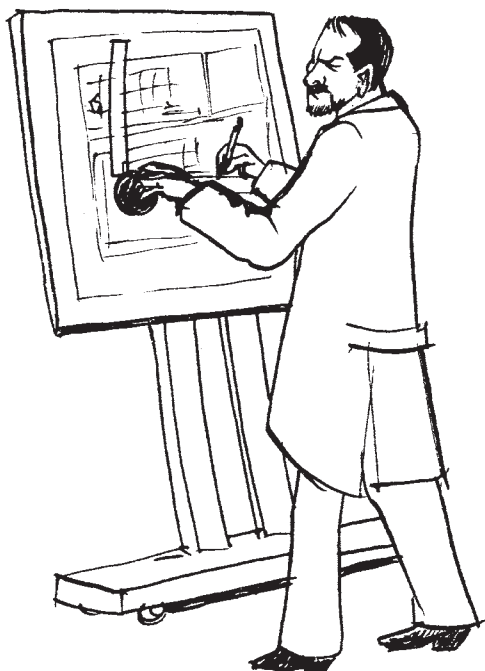

INŽENÝR



INŽENÝRKA



POLICISTA



POLICISTKA

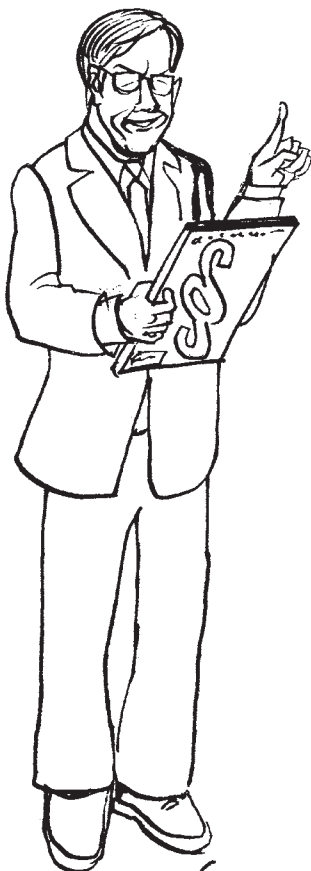

PRAVNÍK



PRAVNÍČKA

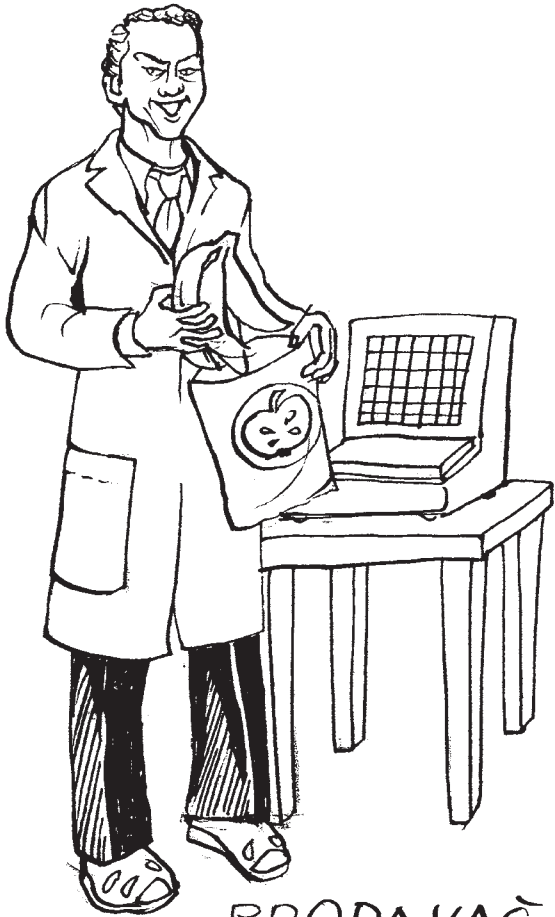

PRODAVAČ

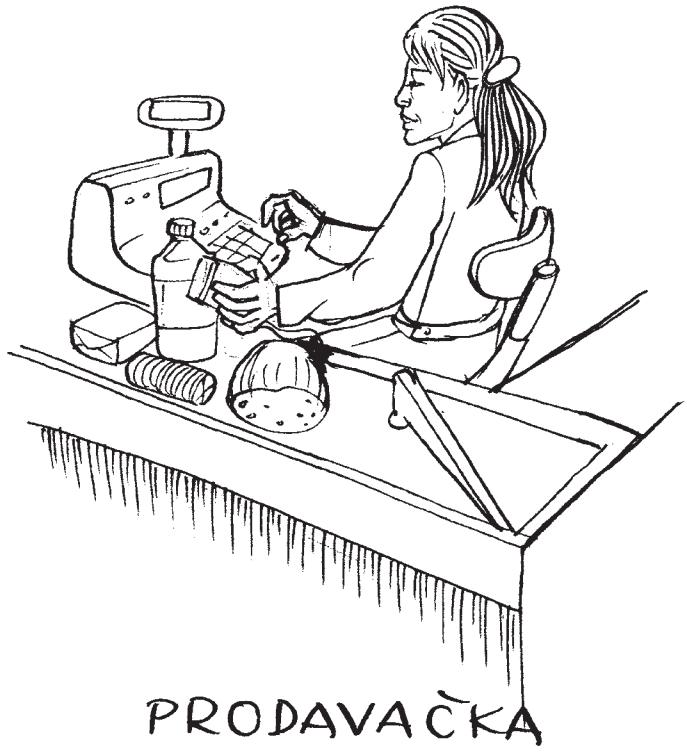

PRODAVAČKA



ŘIDIČ

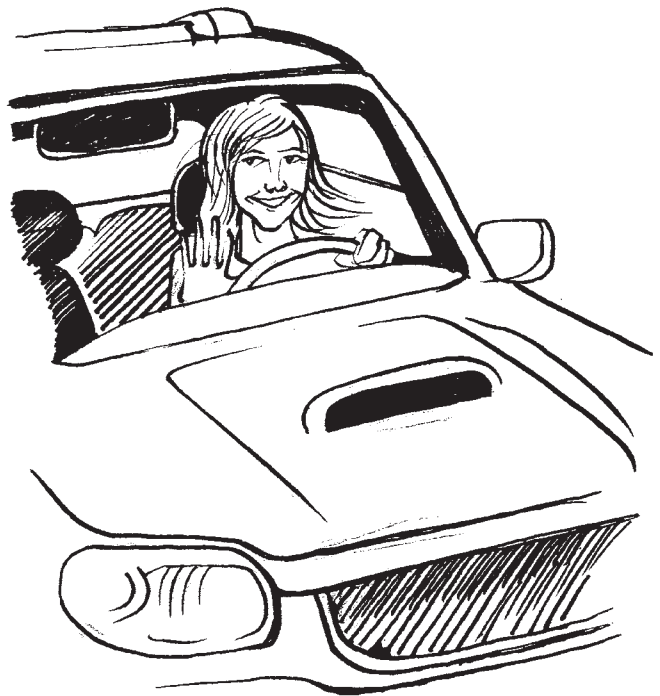

ŘIDIČKA



ŘEDITEL



ŘEDITELKA

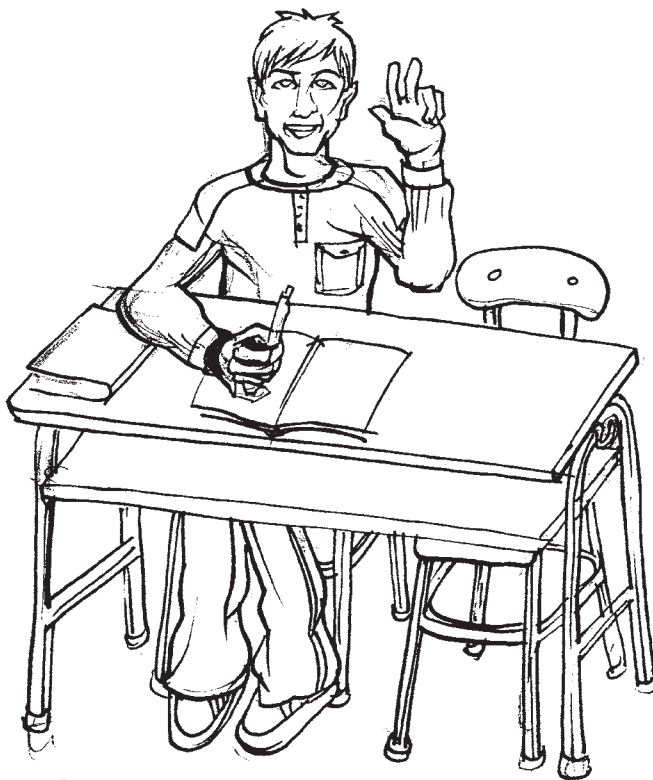

STUDENT



STUDENTKA

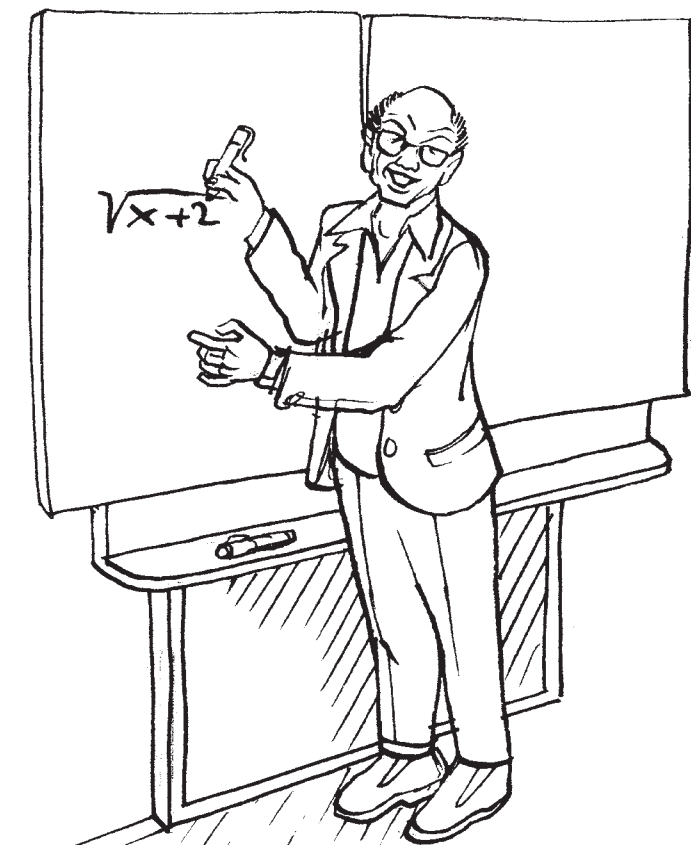

UČITEL

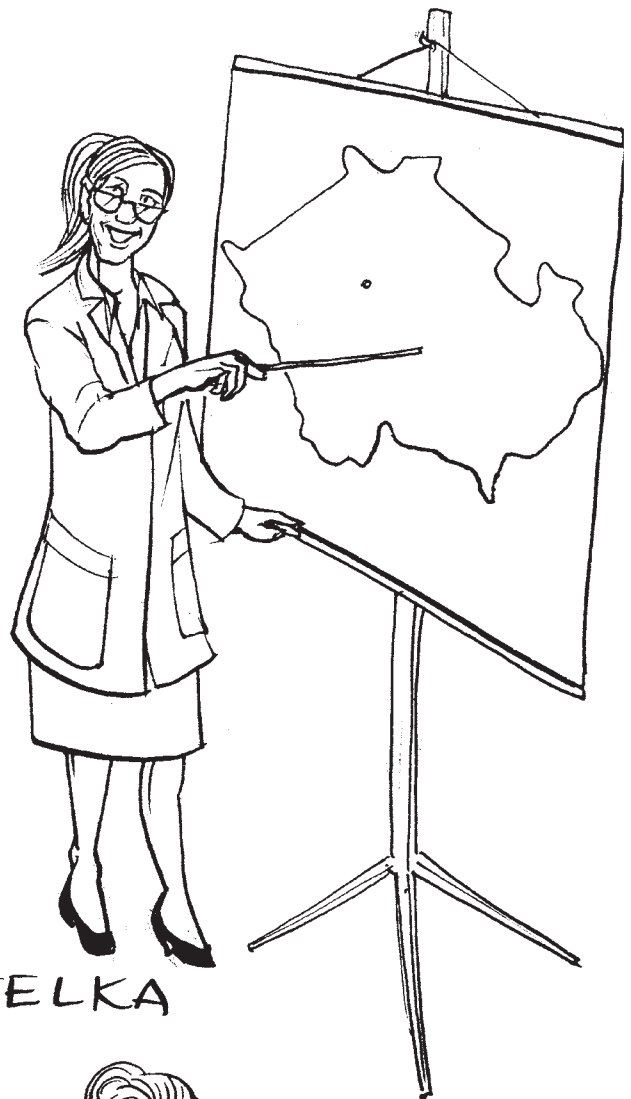

UČITELKA

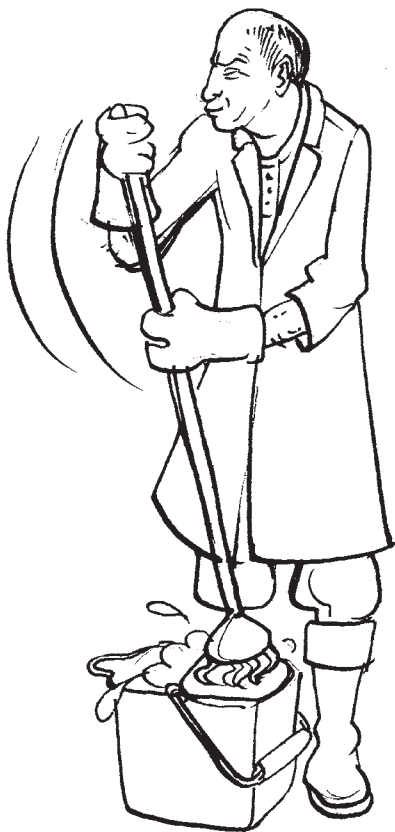

UKLÍZEČ



UKLÍZEČKA





ÚŘEDNÍK



ÚŘEDNICE



V DOMAČNOSTI





VOJAĀK



VOJAĀKA



ZAHRADNĀK



ZAHRADNICE





ZEMĚDĚLEC



ZEMĚDĚLKA



ZUBAŘ



ZUBAŘKA



KUCHARĚ



KUCHARKA



ČIŠNÍK



SERVÍRKA



ZPĚVÁK



ZPĚVAČKA



ZUBAŘ



ZUBAŘKA

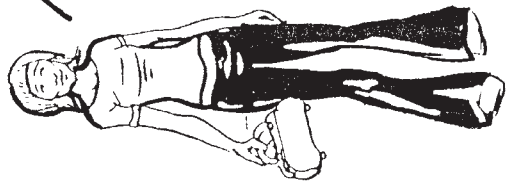
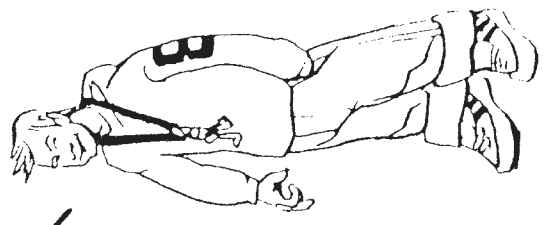
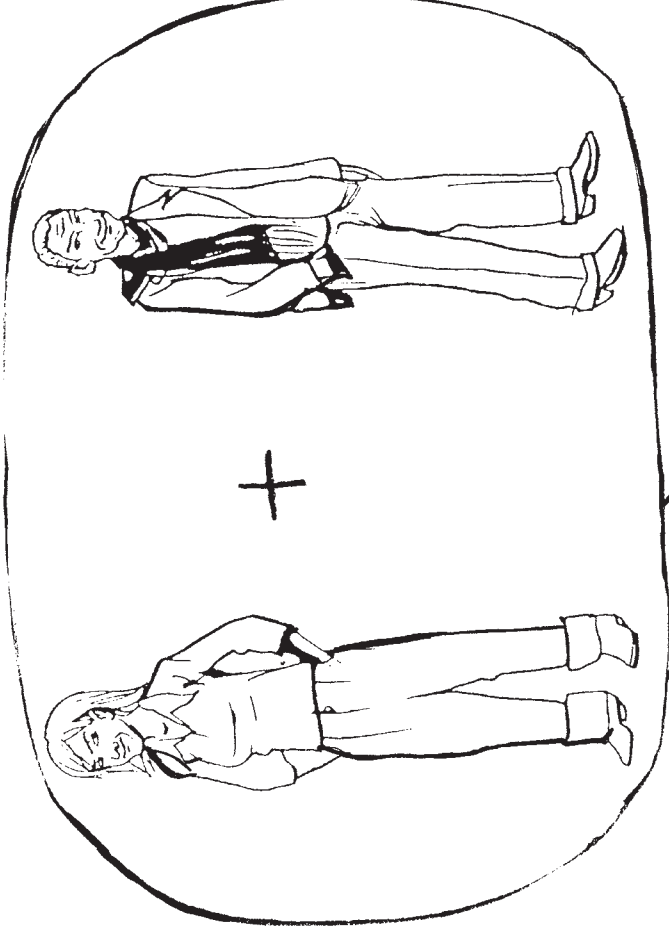
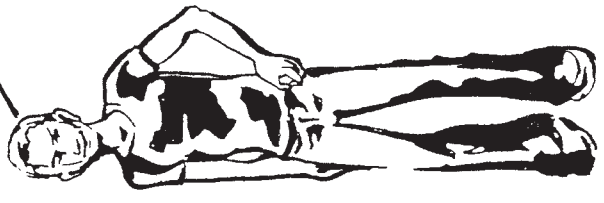
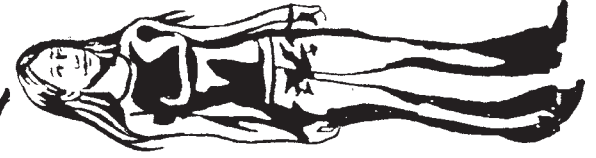
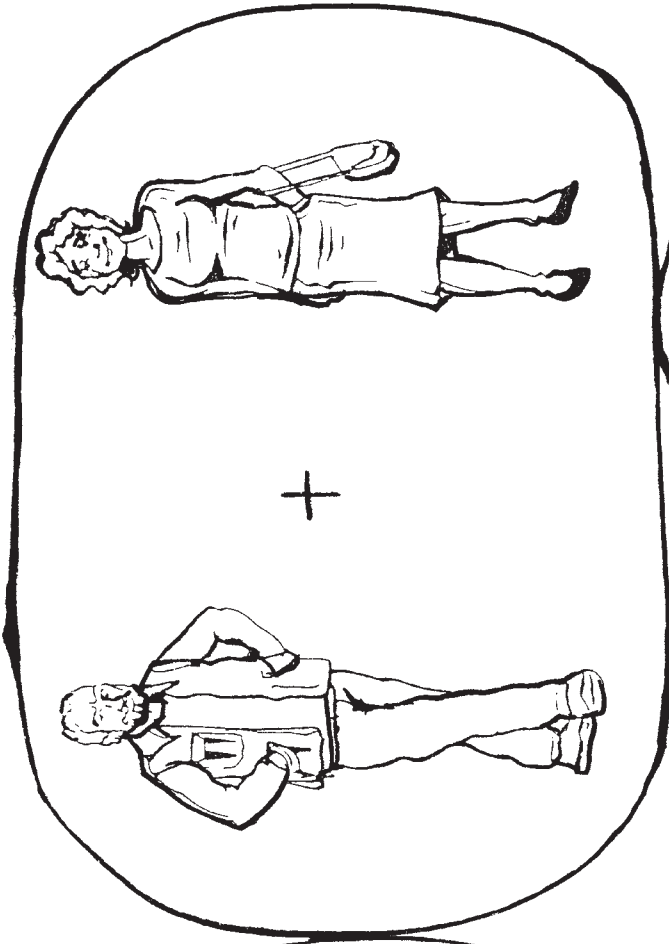

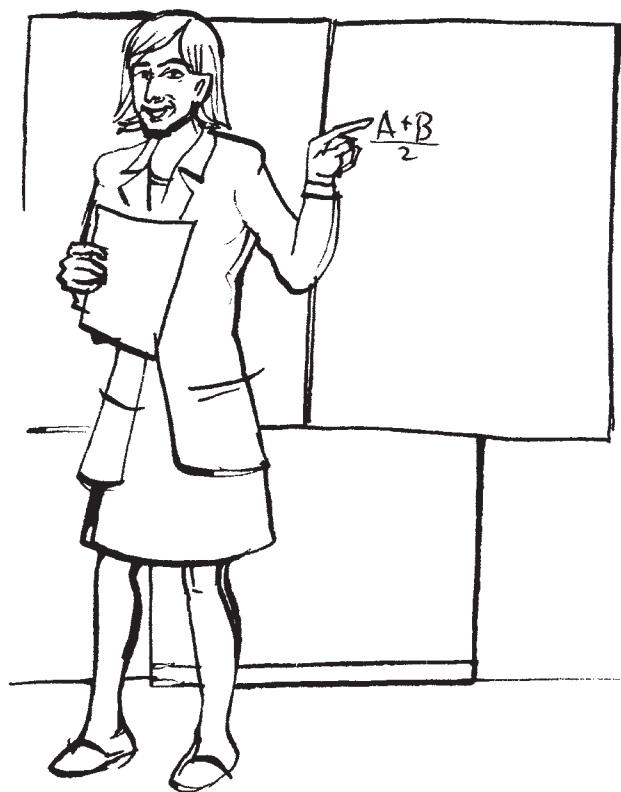

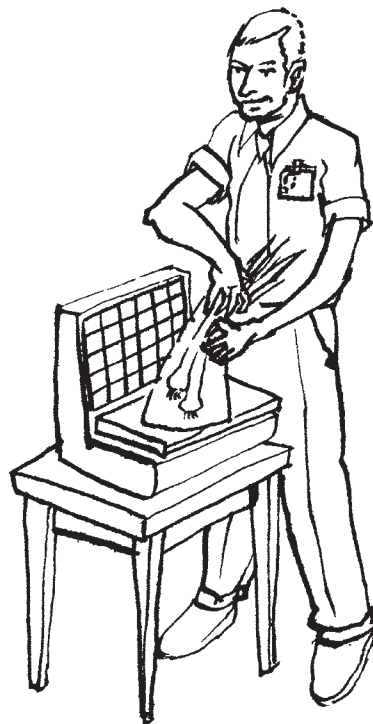
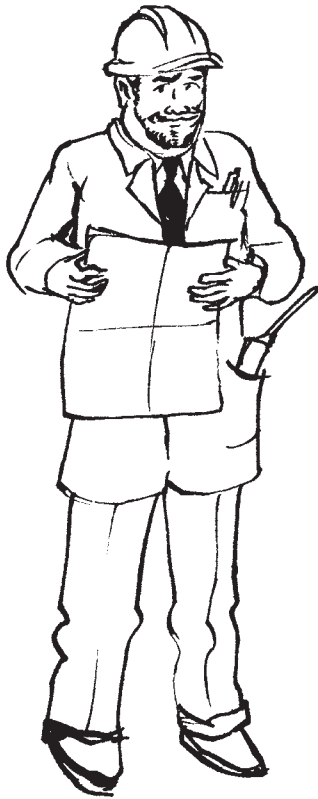

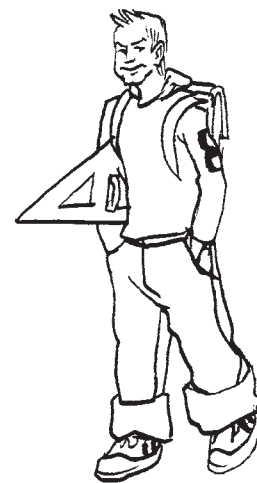
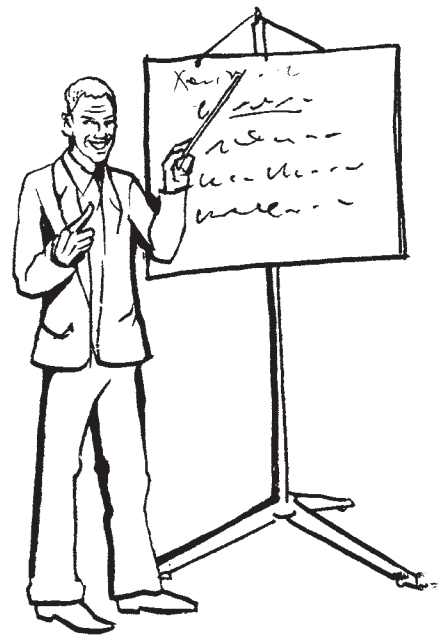
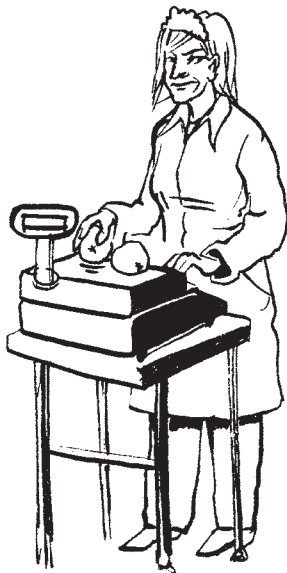



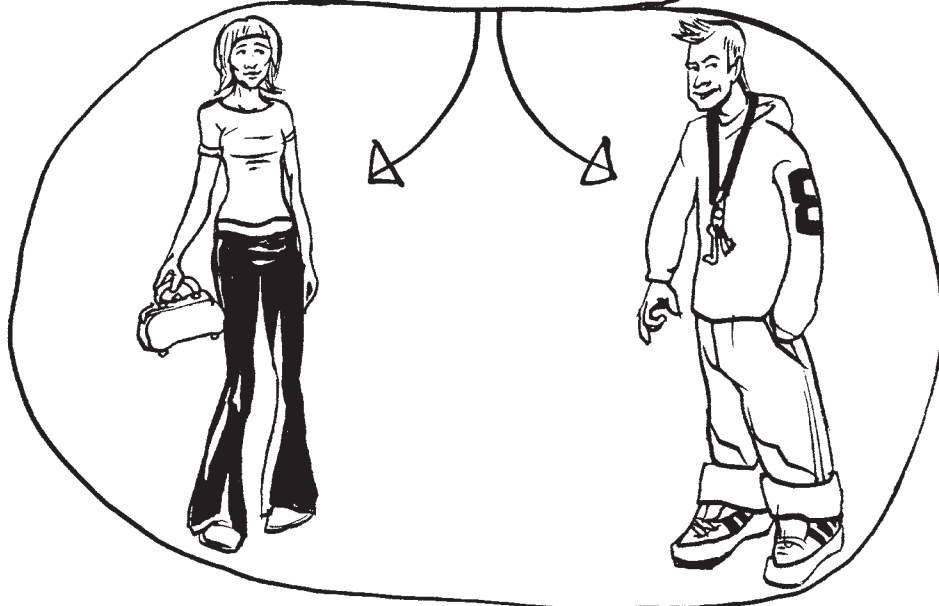
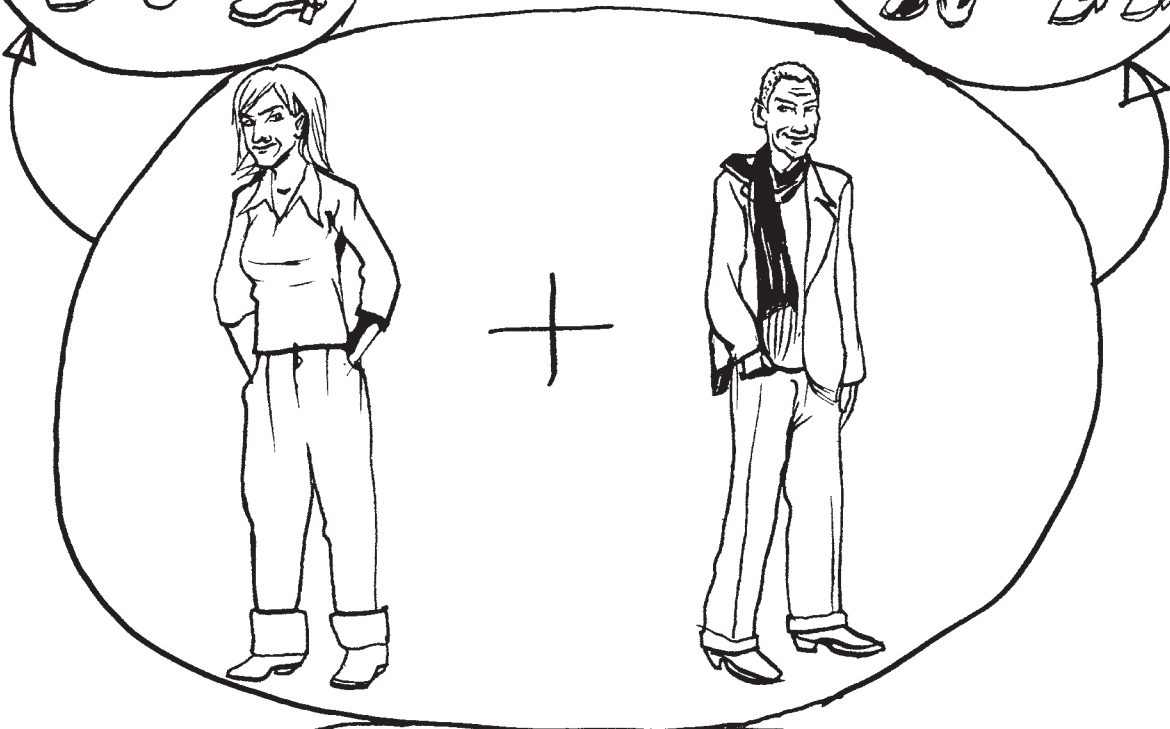



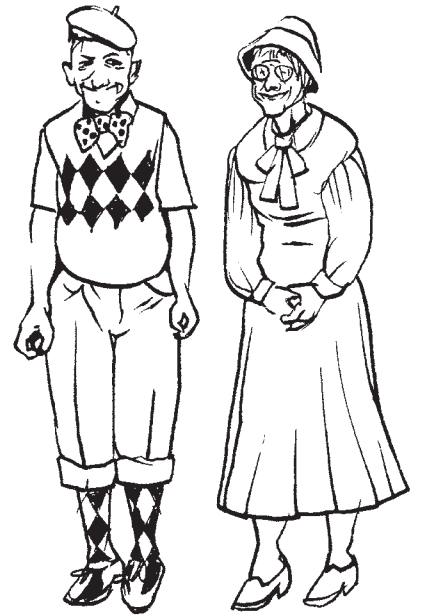

**ADRESA**

JMÉNO:

PŘÍJMENÍ:

ULICE:

ČÍSLO:

MĚSTO:

ZEMĚ:

**ADRESA**

JMÉNO:

PŘÍJMENÍ:

ULICE:

ČÍSLO:

MĚSTO:

ZEMĚ:

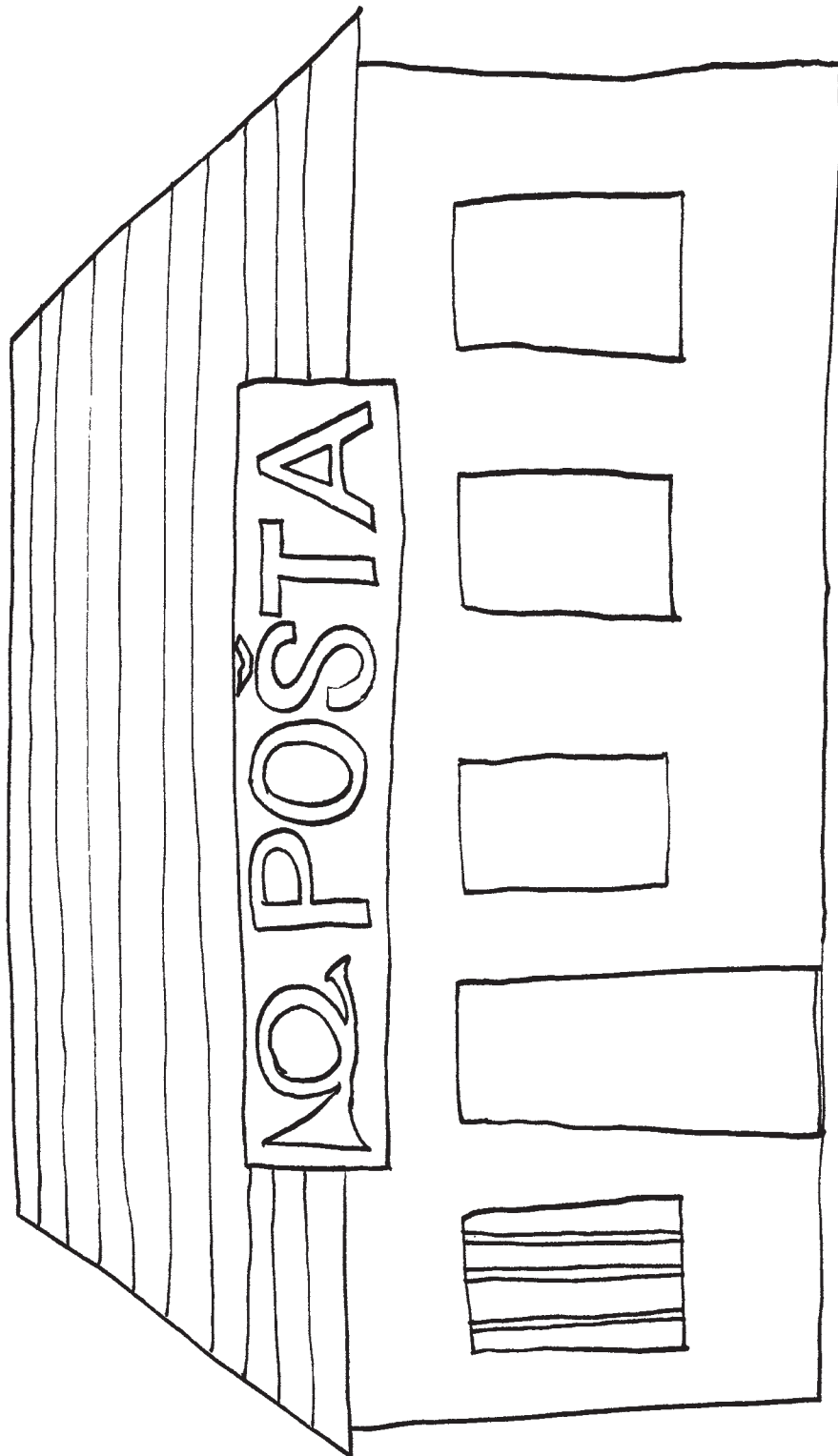

JMÉNO:

PŘÍJMENÍ:

BYDLIŠTĚ:

DATUM NAROZENÍ:

STÁTNÍ PŘÍSLUŠNOST:

JMÉNO:

PŘÍJMENÍ:

BYDLIŠTĚ:

DATUM NAROZENÍ:

STÁTNÍ PŘÍSLUŠNOST:

JMÉNO:

PŘÍJMENÍ:

BYDLIŠTĚ:

DATUM NAROZENÍ:

STÁTNÍ PŘÍSLUŠNOST:

JMÉNO:

PŘÍJMENÍ:

STÁTNÍ PŘÍSLUŠNOST:

BYDLIŠTĚ (ADRESA):

DATUM NAROZENÍ:

JMÉNO:

PŘÍJMENÍ:

STÁTNÍ PŘÍSLUŠNOST:

BYDLIŠTĚ (ADRESA):

DATUM NAROZENÍ:

50 1 2 5 10 20

50 Kč

100

STO  
KORUN ČESKÝCH

DVĚ STĚ  
KORUN ČESKÝCH

200

PĚT SET  
KORUN ČESKÝCH

500

TIŠÍC  
KORUN ČESKÝCH

1000

DVA  
TIŠICE  
KORUN ČESKÝCH

2000

PĚT  
TIŠÍC  
KORUN ČESKÝCH

5000

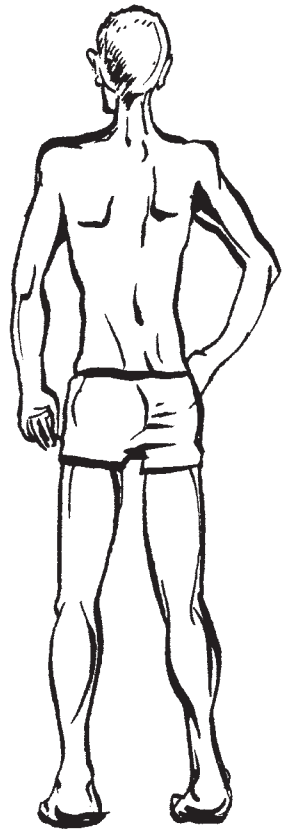

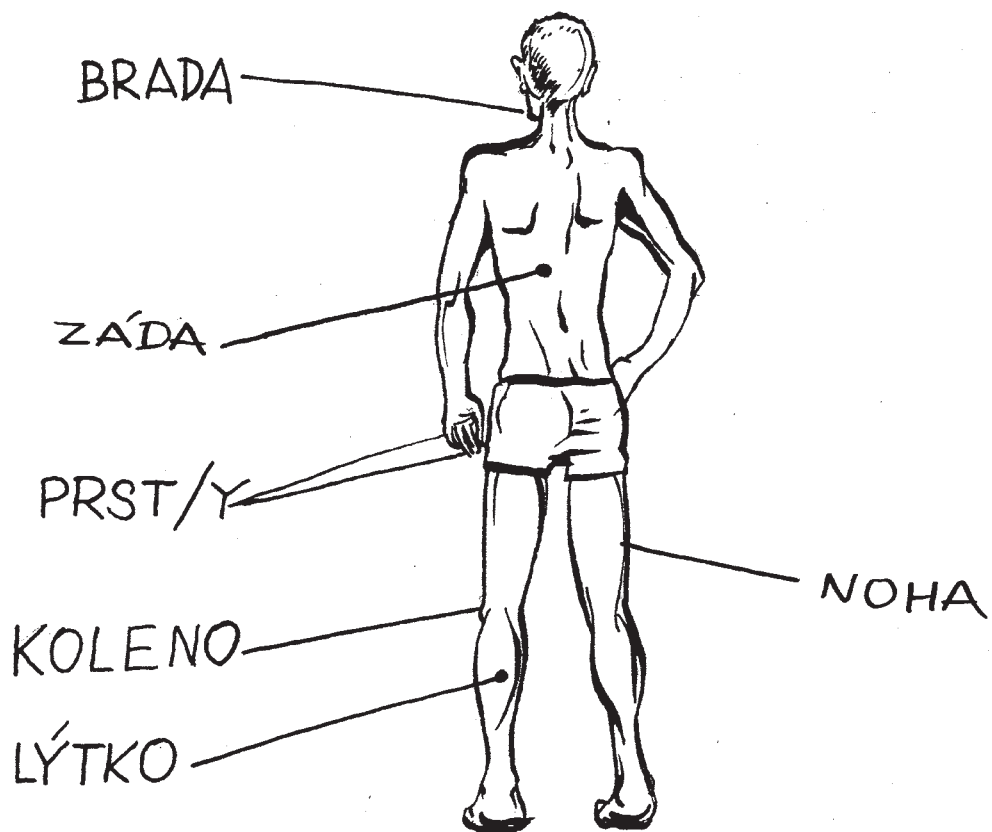
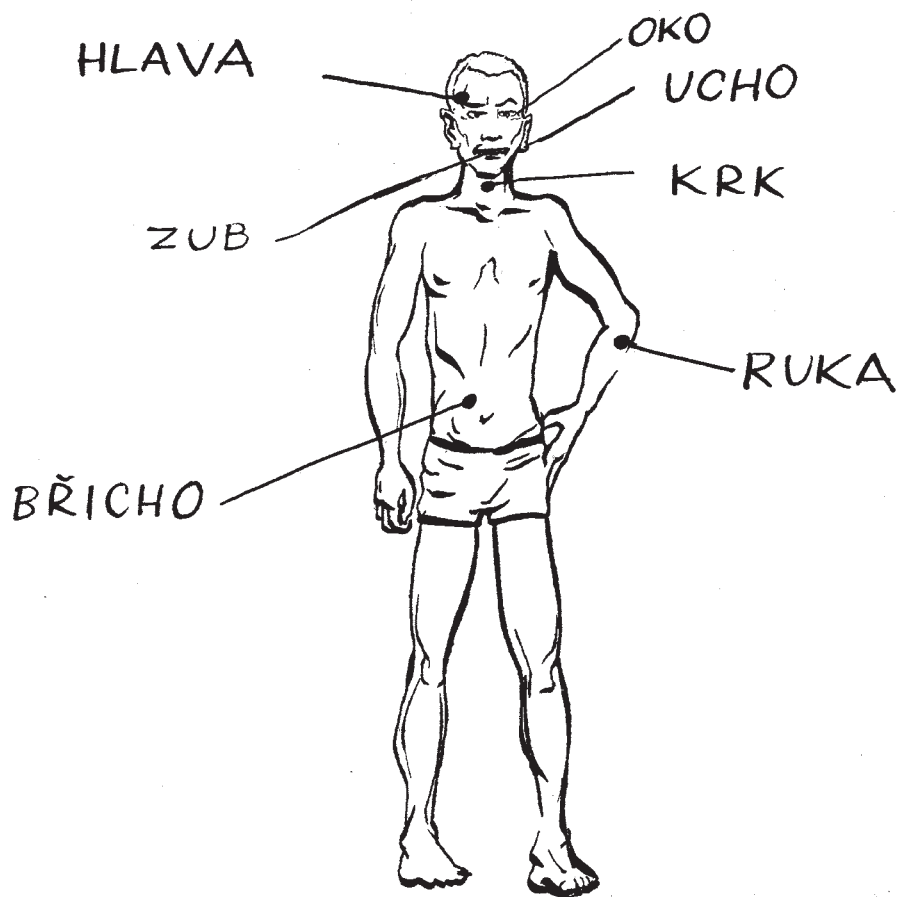



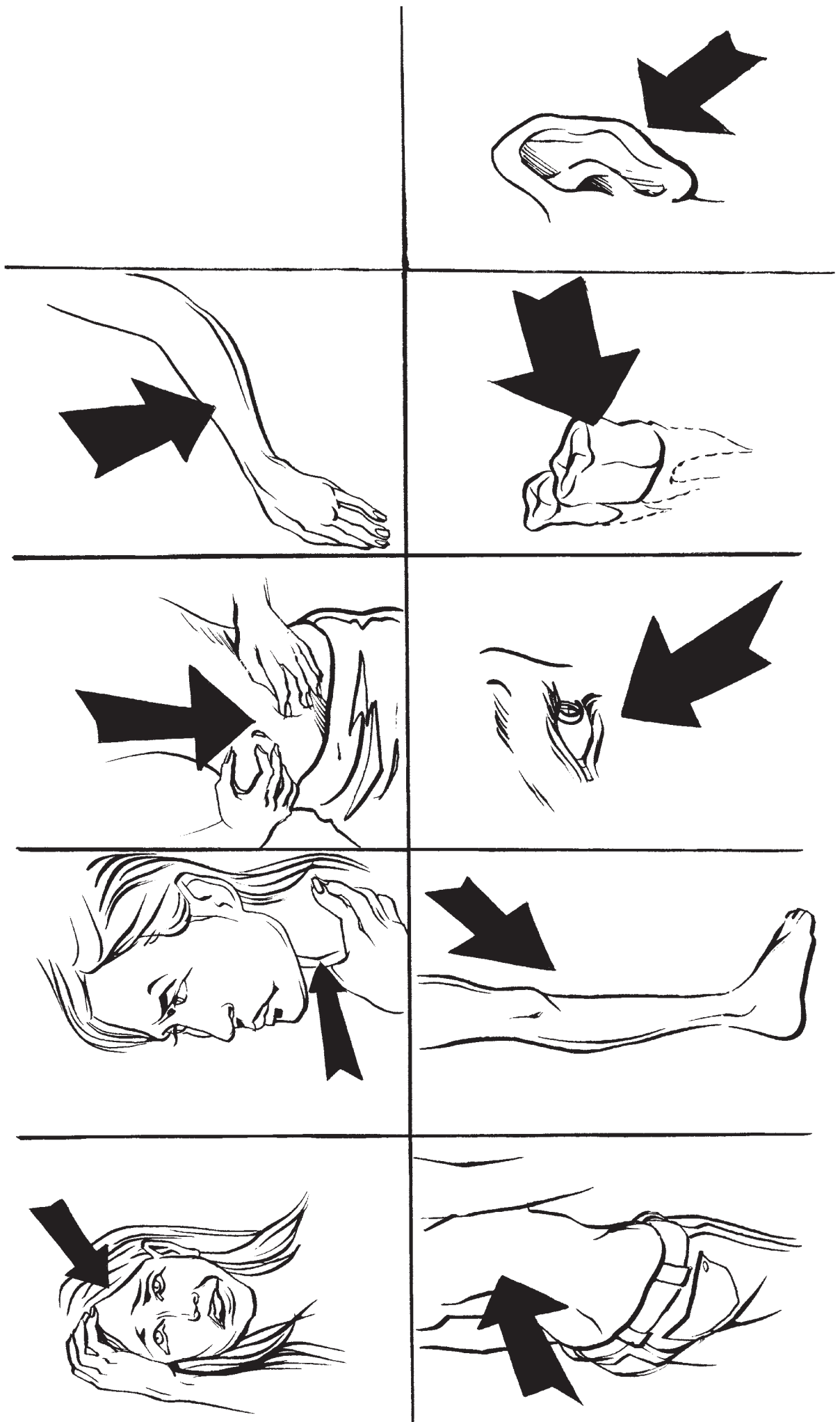

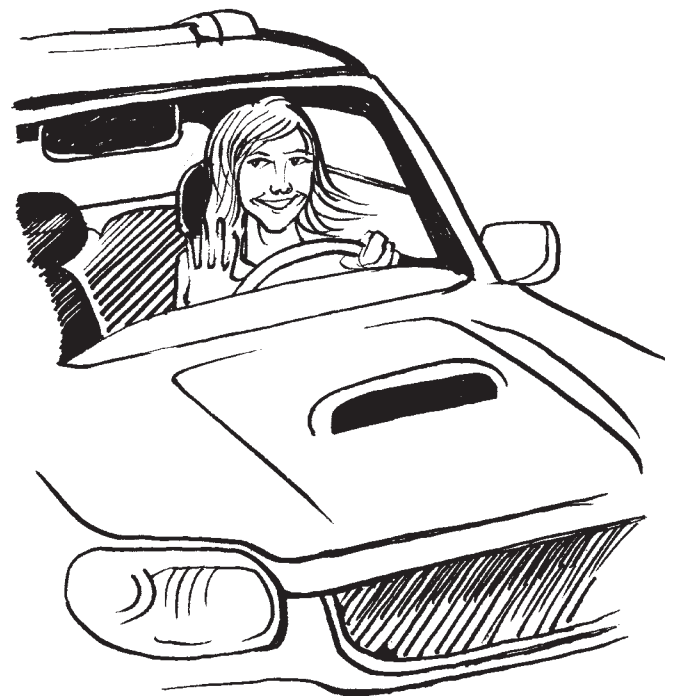
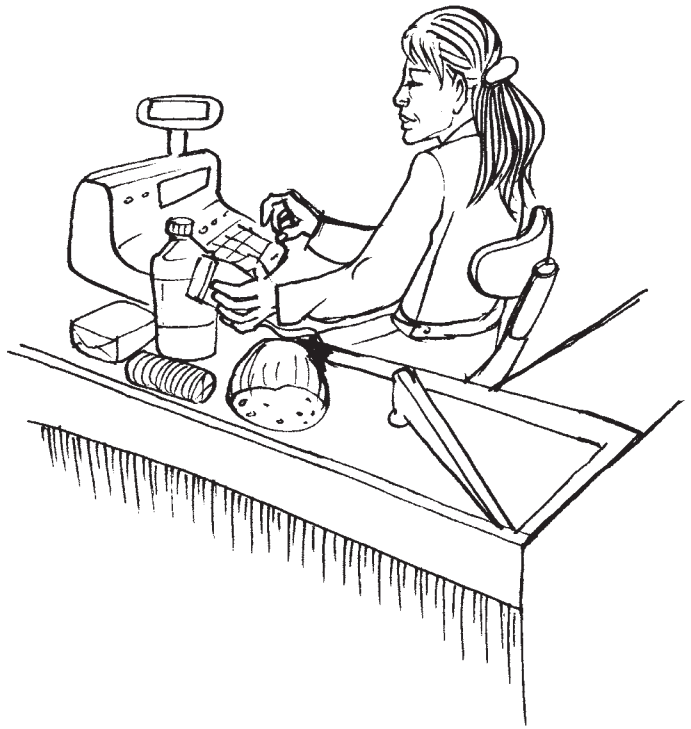

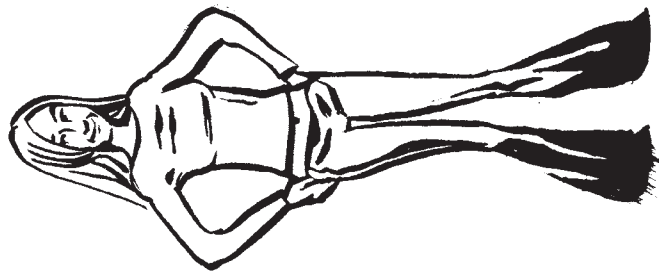
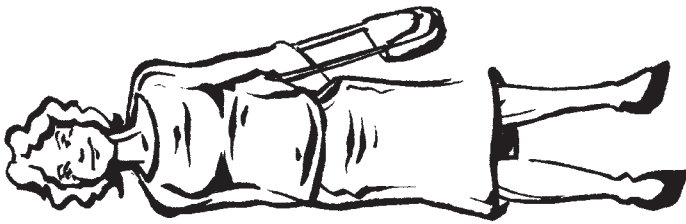
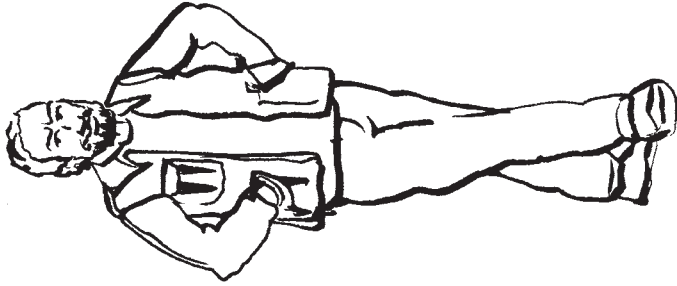

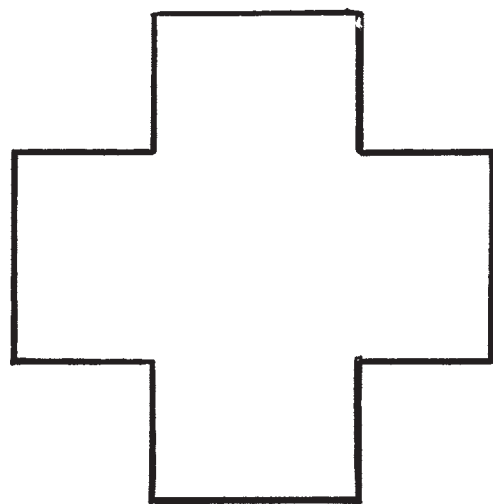

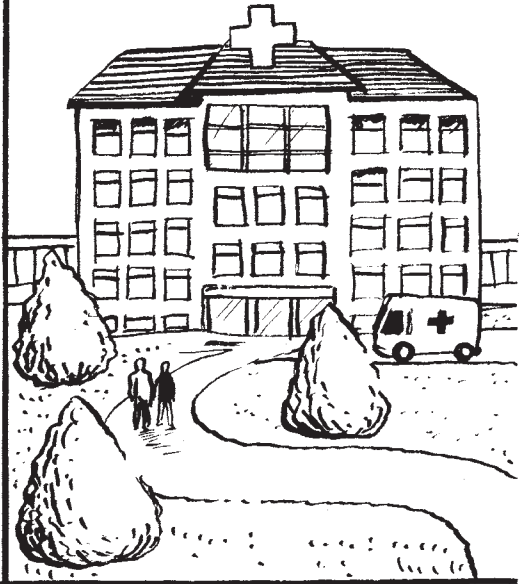

155

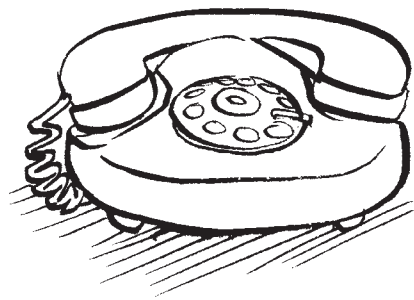

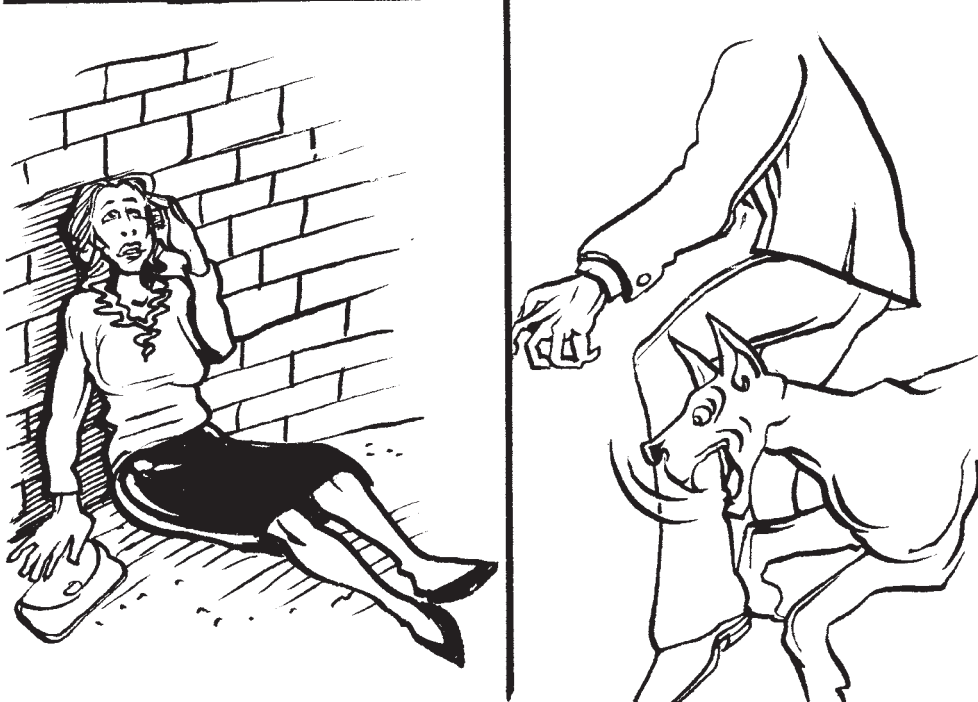

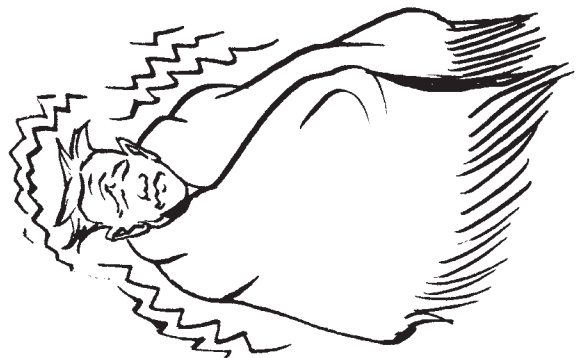
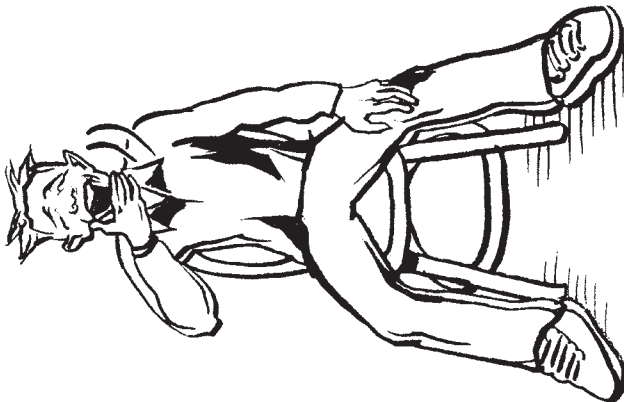
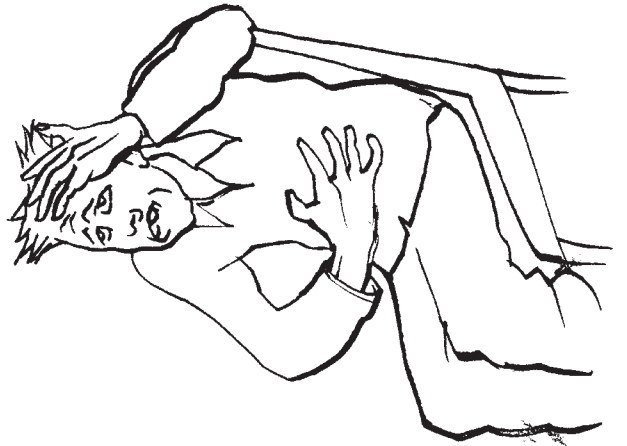

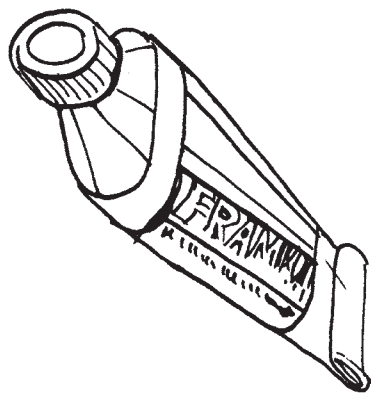
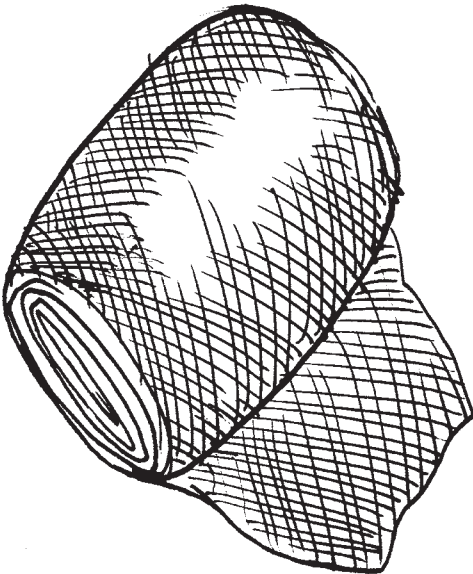
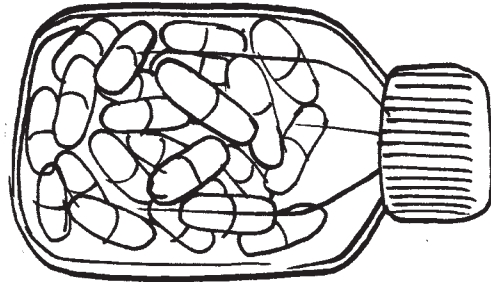
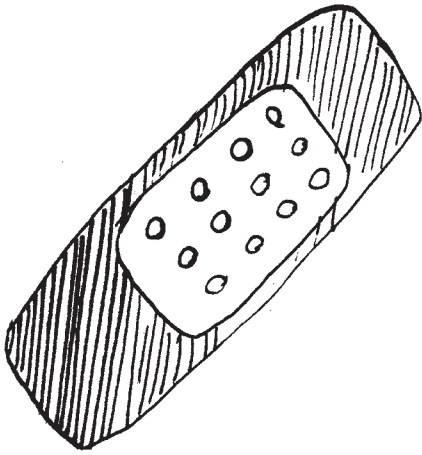
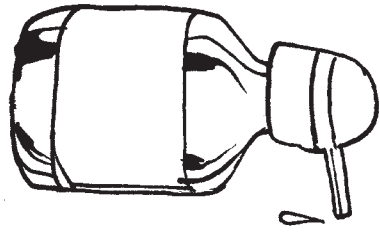
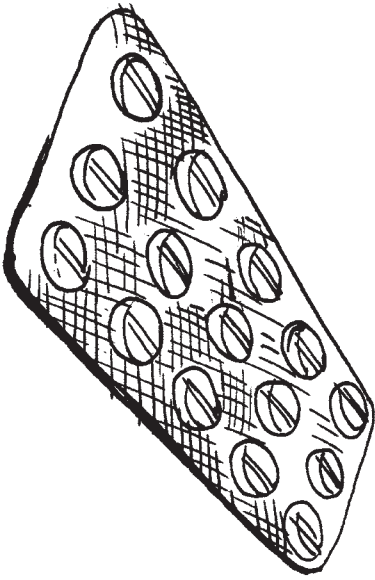



KAPKY

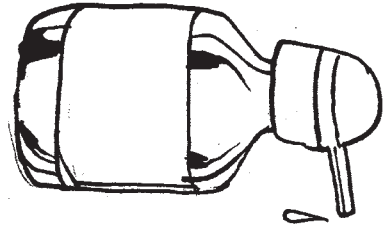

PRAŠKY

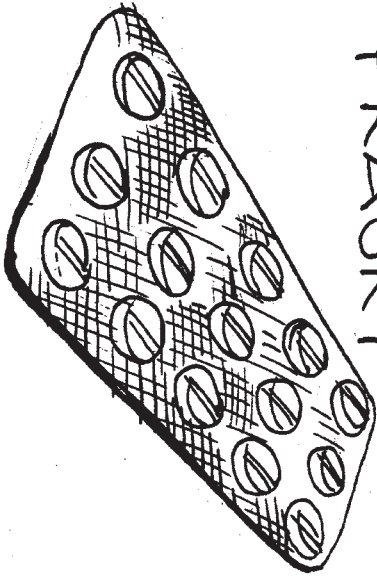

PRAŠKY

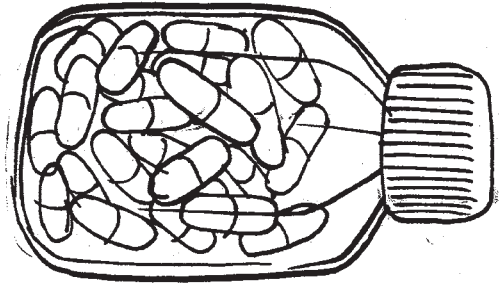

NÁPLAST

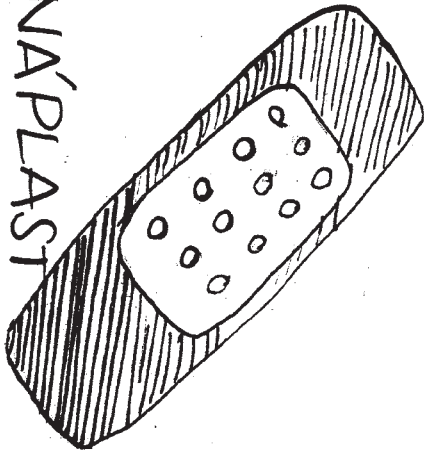

MAST

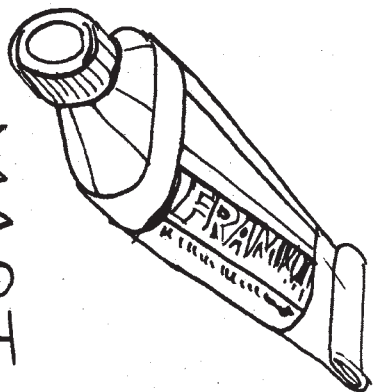

OBVAZ

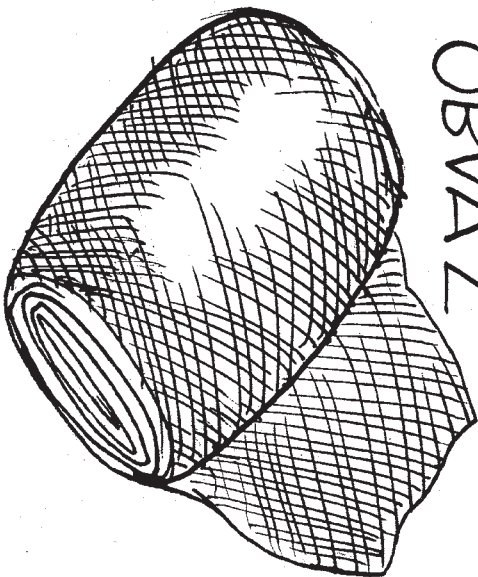

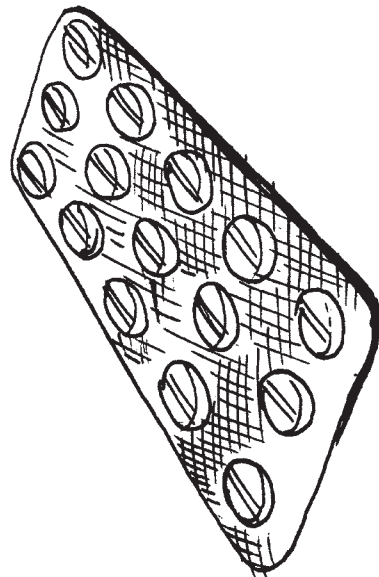
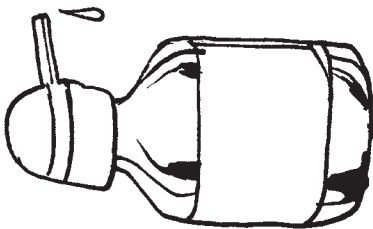
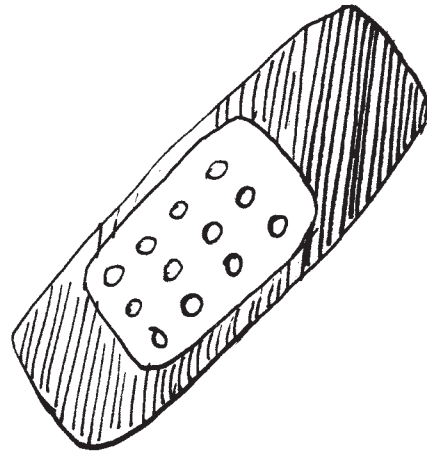
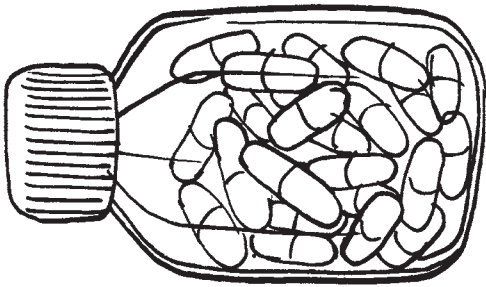
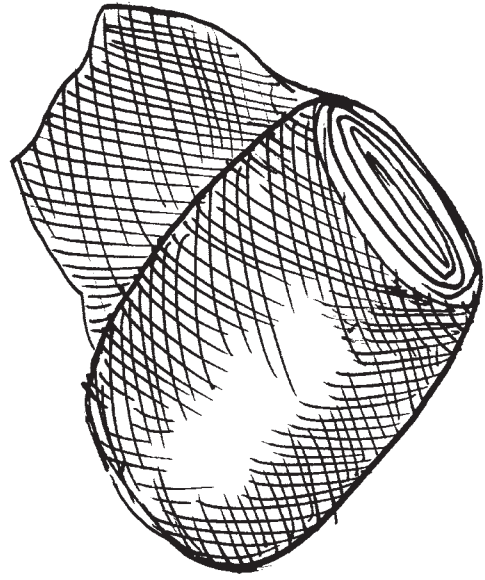
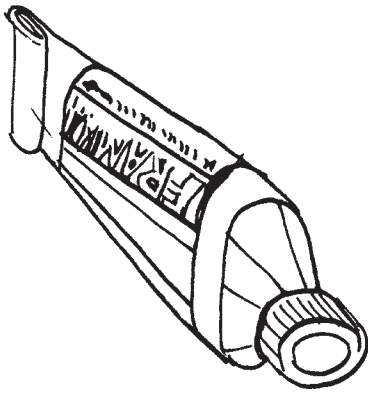



serie AB	poř. č.
 188835	

Příjmení a jméno
Bydliště (adresa)
PSČ

01	MUDr. Fr. Novák
350	ord. prakt. lékař
812	Husitská 72
	PRAHA 3

razítko zdrav. zařízení

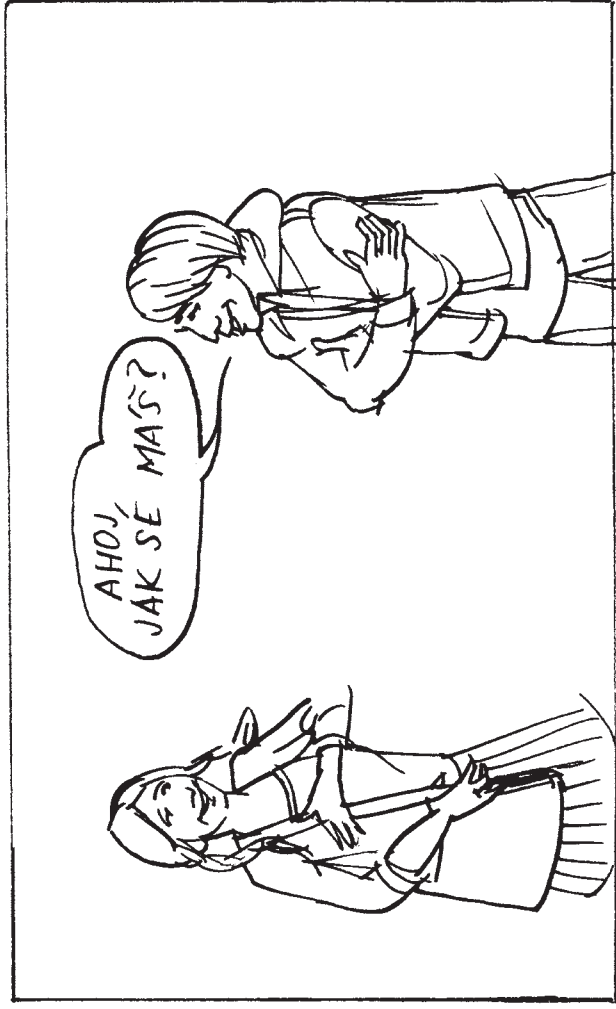
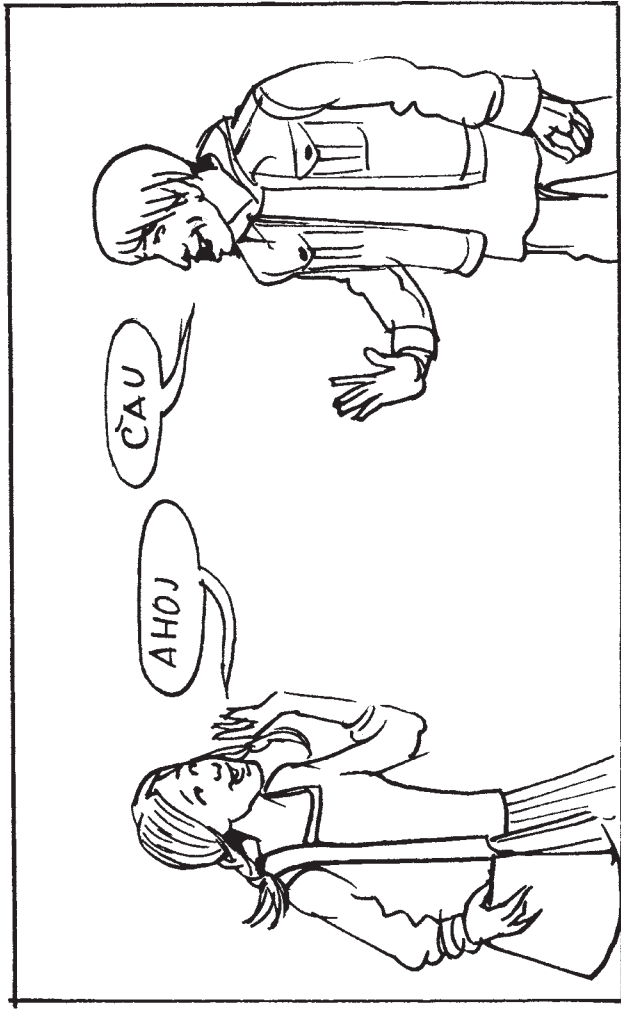

VY JSTE

TY SI



## BÝT

JÁ	JSEM
TY	JSI
ON, ONA, ONO	JE
MY	JSME
VY	JSTE
ONI	JSOU

## BÝT

JÁ	JSEM
TY	JSI
ON, ONA, ONO	JE
MY	JSME
VY	JSTE
ONI	JSOU

## BÝT

JÁ	JSEM
TY	JSI
ON, ONA, ONO	JE
MY	JSME
VY	JSTE
ONI	JSOU

## BÝT

JÁ	JSEM
TY	JSI
ON, ONA, ONO	JE
MY	JSME
VY	JSTE
ONI	JSOU

## BÝT

JÁ	JSEM
TY	JSI
ON, ONA, ONO	JE
MY	JSME
VY	JSTE
ONI	JSOU

## BÝT

JÁ	JSEM
TY	JSI
ON, ONA, ONO	JE
MY	JSME
VY	JSTE
ONI	JSOU

## 1. BÝT

Já ..... tady. → Já **jsem** tady.  
My ..... doma. Oni ..... v práci. Vy ..... tady.  
Ona ..... ve škole. Ty ..... na poště. Já ..... student.  
On ..... doktor. Vy ..... učitel. Pan Novák ..... v práci.  
Petr a Jana ..... tady. Paní Stará ..... učitelka. Já a Jana ..... doma.

## 2. NEBÝT

Já ..... tady. → Já **nejsem** tady.  
Vy ..... v práci. Oni ..... doma. Ty ..... právník.  
On ..... prodavač. Já ..... student. Ona ..... herečka.  
My ..... ve škole. Honza ..... úředník.  
Jana a Petr ..... v restauraci. Já a pan Novák ..... v práci.

## 1. BÝT

Já ..... tady. → Já **jsem** tady.  
My ..... doma. Oni ..... v práci. Vy ..... tady.  
Ona ..... ve škole. Ty ..... na poště. Já ..... student.  
On ..... doktor. Vy ..... učitel. Pan Novák ..... v práci.  
Petr a Jana ..... tady. Paní Stará ..... učitelka. Já a Jana ..... doma.

## 2. NEBÝT

Já ..... tady. → Já **nejsem** tady.  
Vy ..... v práci. Oni ..... doma. Ty ..... právník.  
On ..... prodavač. Já ..... student. Ona ..... herečka.  
My ..... ve škole. Honza ..... úředník.  
Jana a Petr ..... v restauraci. Já a pan Novák ..... v práci.

## MÍT

JÁ	MÁM
TY	MÁŠ
ON, ONA, ONO	MÁ
MY	MÁME
VY	MÁTE
ONI	MAJÍ

## MÍT

JÁ	MÁM
TY	MÁŠ
ON, ONA, ONO	MÁ
MY	MÁME
VY	MÁTE
ONI	MAJÍ

## MÍT

JÁ	MÁM
TY	MÁŠ
ON, ONA, ONO	MÁ
MY	MÁME
VY	MÁTE
ONI	MAJÍ

## MÍT

JÁ	MÁM
TY	MÁŠ
ON, ONA, ONO	MÁ
MY	MÁME
VY	MÁTE
ONI	MAJÍ

## MÍT

JÁ	MÁM
TY	MÁŠ
ON, ONA, ONO	MÁ
MY	MÁME
VY	MÁTE
ONI	MAJÍ

## MÍT

JÁ	MÁM
TY	MÁŠ
ON, ONA, ONO	MÁ
MY	MÁME
VY	MÁTE
ONI	MAJÍ



## 1. MÍT

Já ..... sešit. → Já **mám** sešit.  
My ..... čas. Oni ..... nové auto.  
Já ..... sestru. Ty ..... dobré jablko.  
On ..... hlad. Ona ..... žízeň.  
Petr a Jana ..... nový dům. Já a ty ..... češtinu.  
Kdy ..... čas? (vy)

## 2. NEMÍT

Já ..... sešit. → Já **nemám** sešit.  
Já ..... peníze. Já a ty ..... v pátek češtinu.  
On ..... sestru. Ona ..... dítě.  
Oni ..... hlad. Petr a Ivana ..... nový dům.  
Ty a on ..... žízeň.

## 1. MÍT

Já ..... sešit. → Já **mám** sešit.  
My ..... čas. Oni ..... nové auto.  
Já ..... sestru. Ty ..... dobré jablko.  
On ..... hlad. Ona ..... žízeň.  
Petr a Jana ..... nový dům. Já a ty ..... češtinu.  
Kdy ..... čas? (vy)

## 2. NEMÍT

Já ..... sešit. → Já **nemám** sešit.  
Já ..... peníze. Já a ty ..... v pátek češtinu.  
On ..... sestru. Ona ..... dítě.  
Oni ..... hlad. Petr a Ivana ..... nový dům.  
Ty a on ..... žízeň.

## JAKÁ?

TA	PAPIKA OKURKA ČOKOLÁDA TUŽKA BLŮZA BUNDA ŠÁLA	ČERVENÁ ZELENÁ HNĚDÁ ČERNÁ ŽLUTÁ MODRÁ BÍLÁ	Á
----	---	---	---

## JAKÝ?

TEN	BANÁN POMERANČ CITRON MELOUN SALÁT JOGURT PAPIR SEŠIT SVETR	ŽLUTÝ ORANŽOVÝ ŽLUTÝ ČERVENÝ ZELENÝ BÍLÝ BÍLÝ BÍLÝ HNĚDÝ	Ý
-----	---	--	---

## JAKÉ?

TO	JABLKO TRIČKO MÁSLLO MLÉKO MASO MÝDLO AUTO	ČERVENÉ MODRÉ BÍLÉ BÍLÉ ČERVENÉ ŽLUTÉ ZELENÉ	É
----	--	--	---

1	2	3
4	5	6
7	8	9

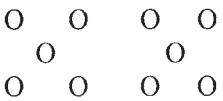
<p><b>10</b></p>  <p>deset</p>	<p><b>11</b></p> <p>jedenáct</p>	<p><b>12</b></p> <p>dvanáct</p>
<p><b>13</b></p> <p>třináct</p>	<p><b>14</b></p> <p>čtrnáct</p>	<p><b>15</b></p> <p>patnáct</p>
<p><b>16</b></p> <p>šestnáct</p>	<p><b>17</b></p> <p>sedmnáct</p>	<p><b>18</b></p> <p>osmnáct</p>

10	11	12
13	14	15
16	17	18

1	JEDNA	11	JEDENÁCT
2	DVĚ	12	DVANÁCT
3	TŘI	13	TŘINÁCT
4	ČTYŘI	14	ČTRNÁCT
5	PĚT	15	PATNÁCT
6	ŠEST	16	ŠESTNÁCT
7	SEDM	17	SEDMNÁCT
8	OSM	18	OSMNÁCT
9	DEVĚT	19	DEVATENÁCT
10	DESET	20	DVACET

21	DVACET JEDNA
22	DVACET DVA
23	DVACET TŘI
24	DVACET ČTYŘI
25	DVACET PĚT
26	DVACET ŠEST
27	DVACET SEM
28	DVACET OSM
29	DVACET DEVĚT

100	21	32
43	54	65
76	87	98

19	20	30
40	50	60
70	80	90



**19**

devatenáct

**20**

dvacet

**21**

dvacet  
jedna

**20**

dvacet

**30**

třicet

**40**

čtyřicet

**50**

padesát

**60**

šedesát

**70**

sedmdesát

**80**

osmdesát

**90**

devadesát

**100**

sto

<p style="text-align: center;"><b>1</b></p> <p style="text-align: center;">○</p> <p style="text-align: center;">jedna</p>	<p style="text-align: center;"><b>2</b></p> <p style="text-align: center;">○ ○</p> <p style="text-align: center;">dvě</p>	<p style="text-align: center;"><b>3</b></p> <p style="text-align: center;">○ ○ ○</p> <p style="text-align: center;">tři</p>
<p style="text-align: center;"><b>4</b></p> <p style="text-align: center;">○ ○ ○ ○</p> <p style="text-align: center;">čtyři</p>	<p style="text-align: center;"><b>5</b></p> <p style="text-align: center;">○ ○ ○ ○ ○</p> <p style="text-align: center;">pět</p>	<p style="text-align: center;"><b>6</b></p> <p style="text-align: center;">○ ○ ○ ○ ○ ○</p> <p style="text-align: center;">šest</p>
<p style="text-align: center;"><b>7</b></p> <p style="text-align: center;">○ ○ ○ ○ ○ ○ ○</p> <p style="text-align: center;">sedm</p>	<p style="text-align: center;"><b>8</b></p> <p style="text-align: center;">○ ○ ○ ○ ○ ○ ○ ○</p> <p style="text-align: center;">osm</p>	<p style="text-align: center;"><b>9</b></p> <p style="text-align: center;">○ ○ ○ ○ ○ ○ ○ ○ ○</p> <p style="text-align: center;">devět</p>

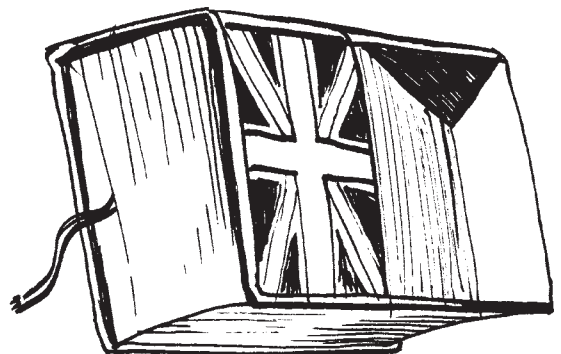
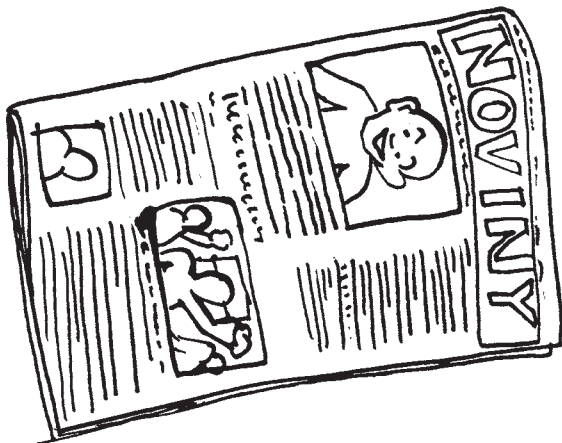
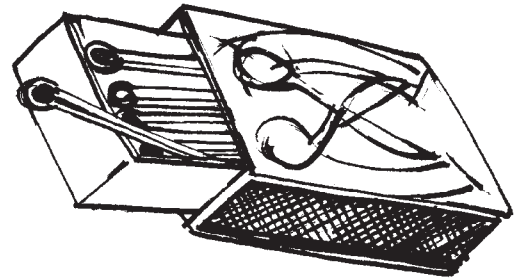
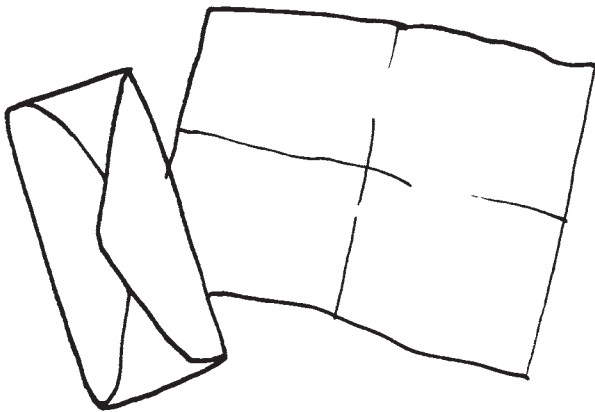
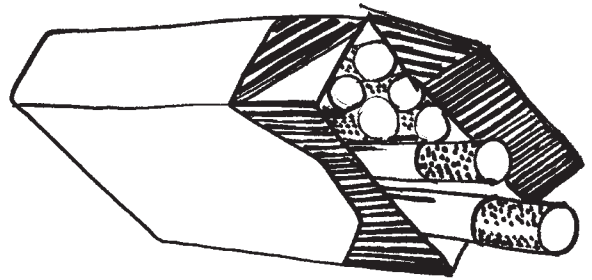
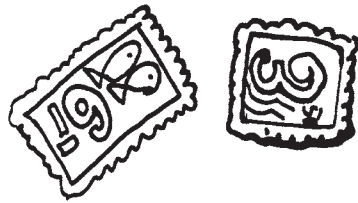
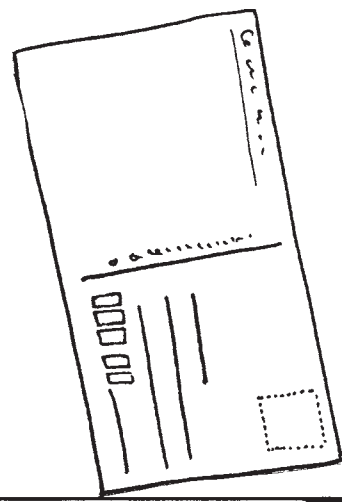

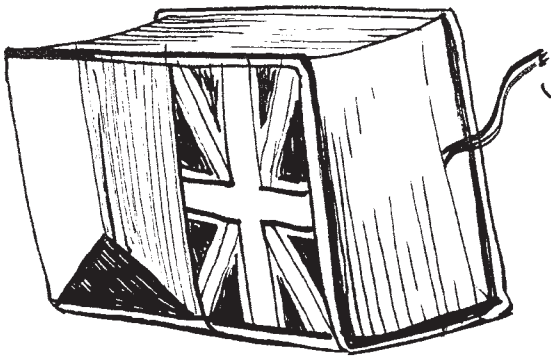

SLOVNÍK

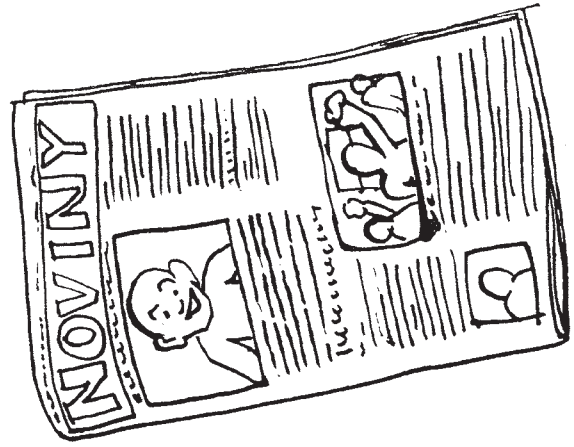

NOVINY

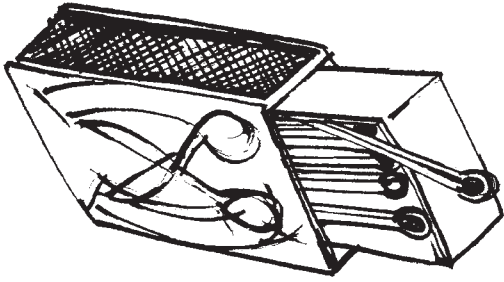

ZÁPALKY

DOPIŠNÍ PAPIŘ

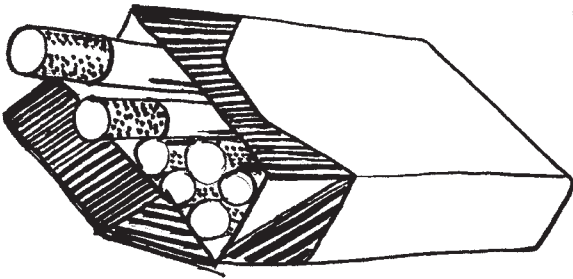
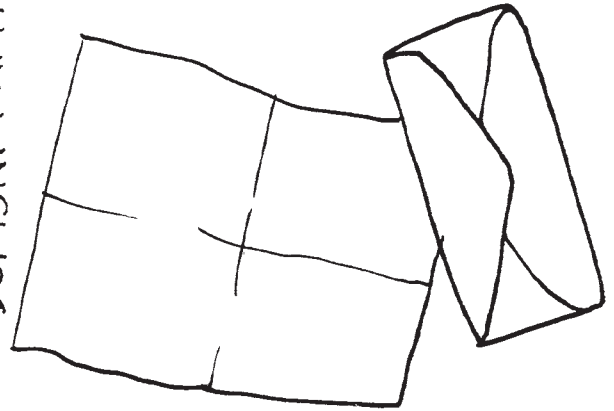

CIGARETY

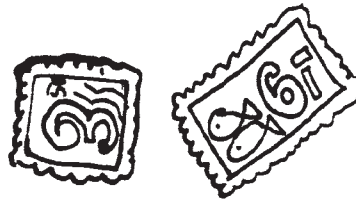

ZNAČKY

POHLEDNICE

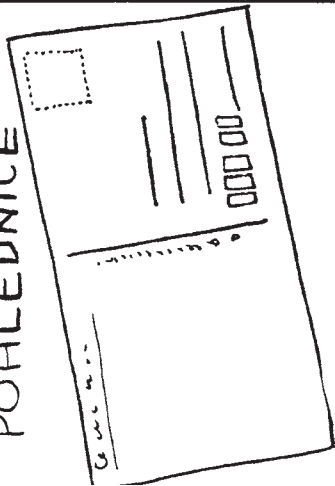

ČASOPIS

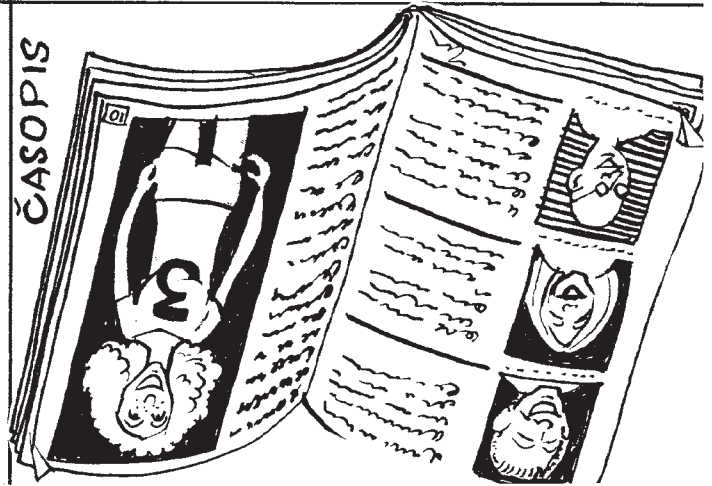

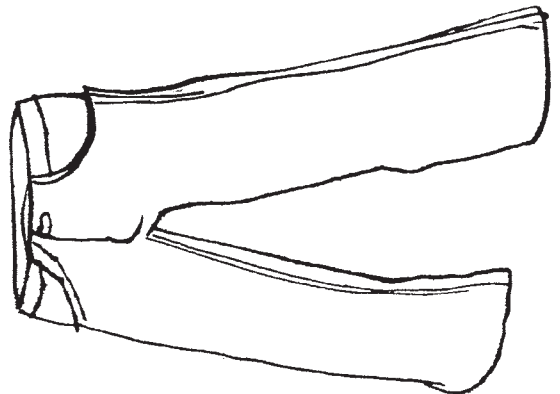
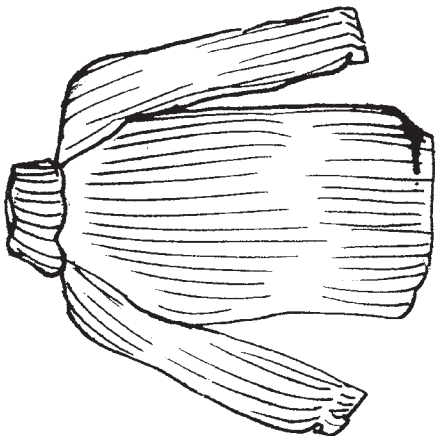
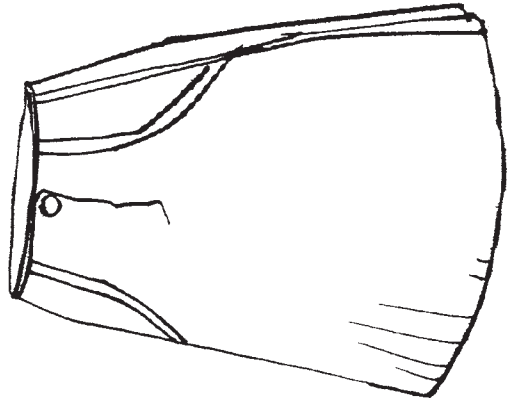
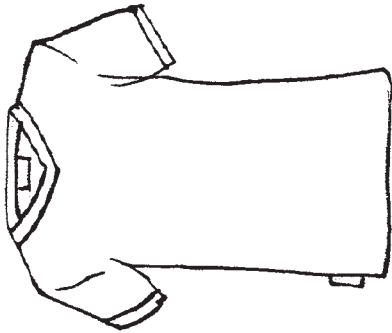
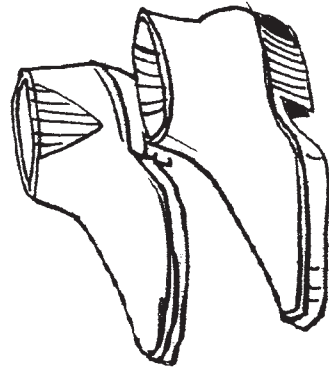
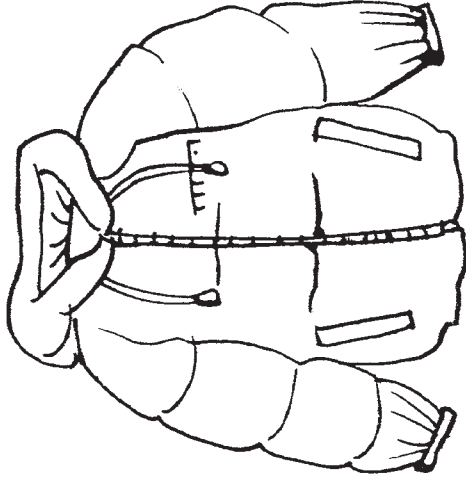
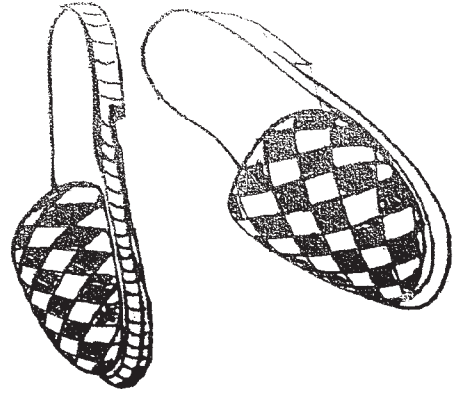
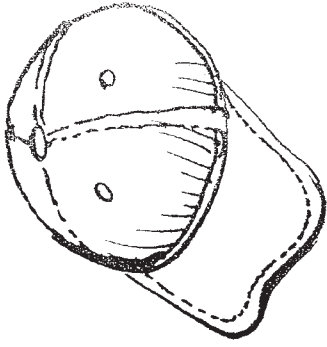

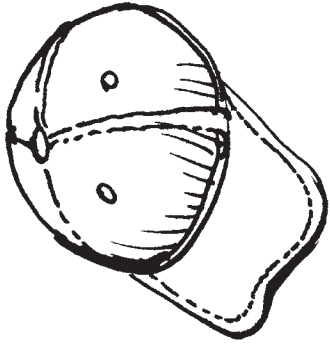

ČEPICE

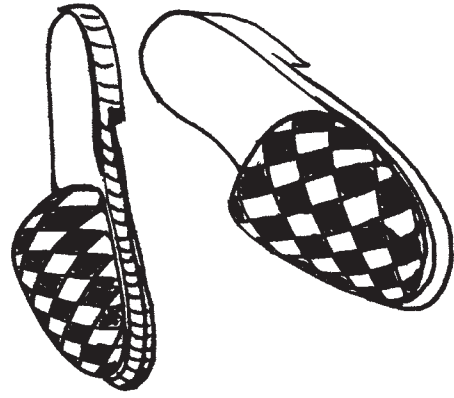

PANTOFLE

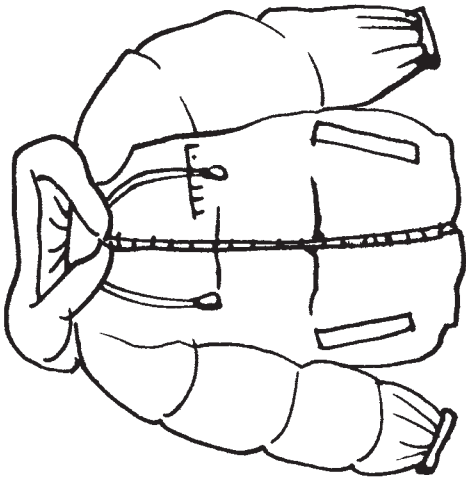

BUNDA

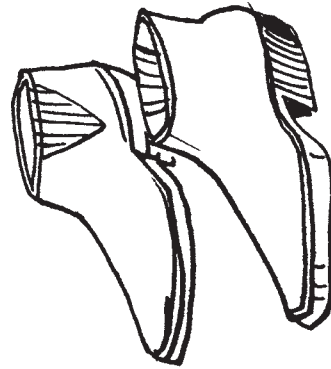

BOTY

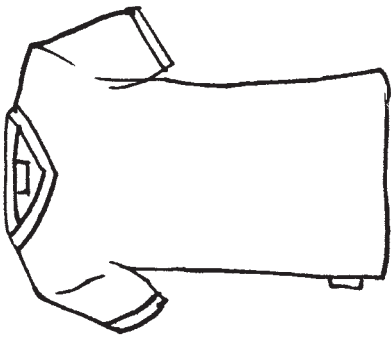

TRIČKO

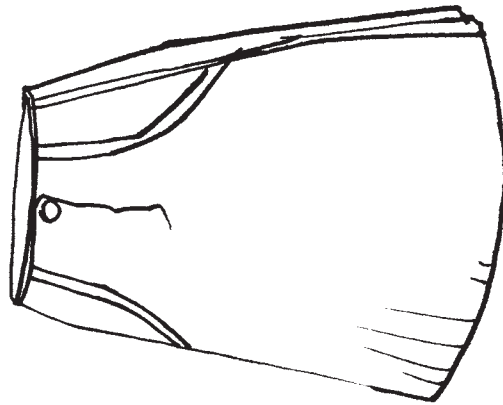

SUKNĚ

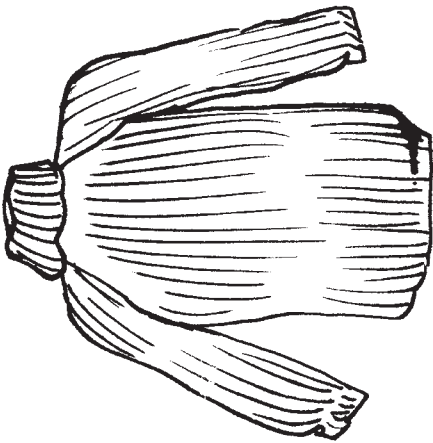

SVETR

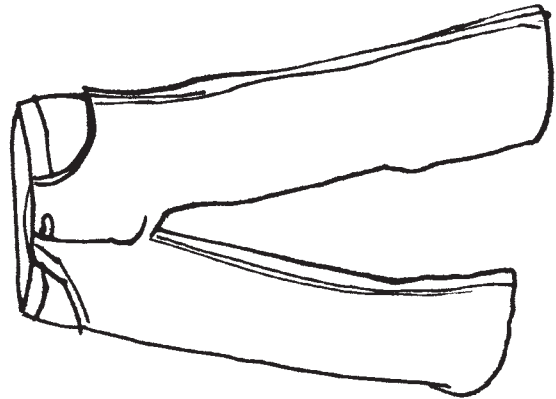

KALHOTY

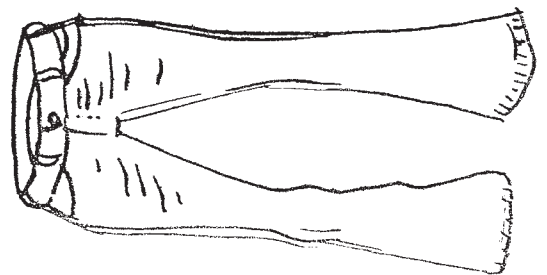
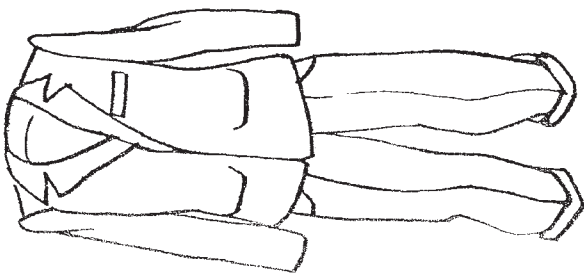
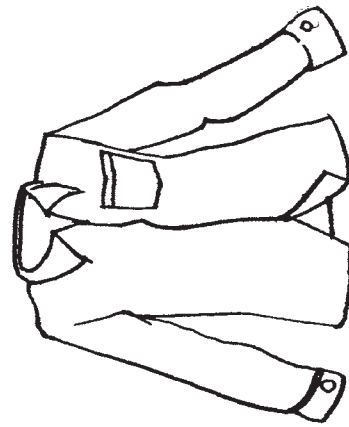
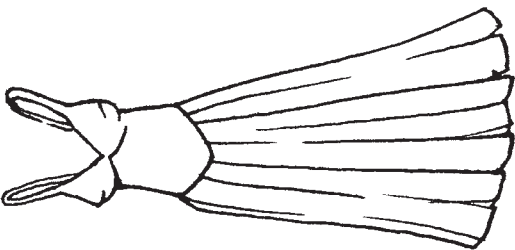
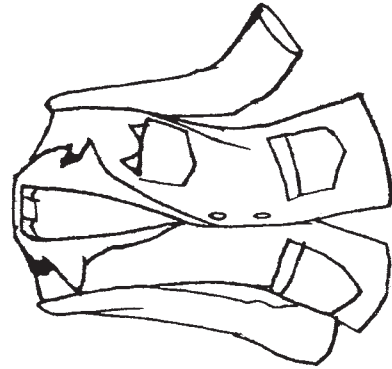
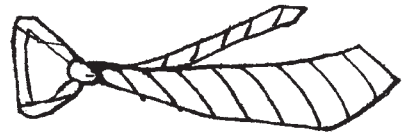
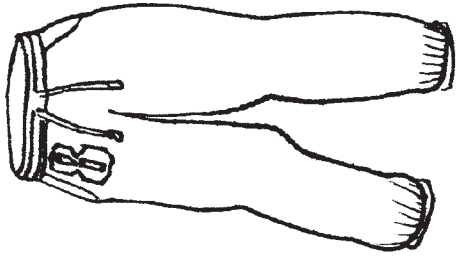

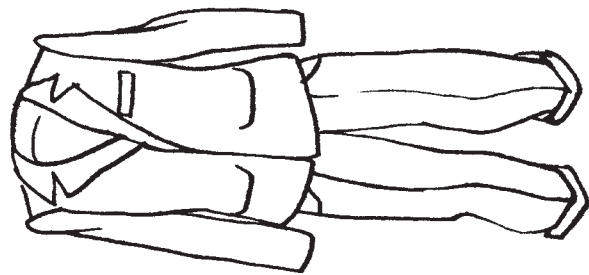

OBLEK (PAŇSKÝ)

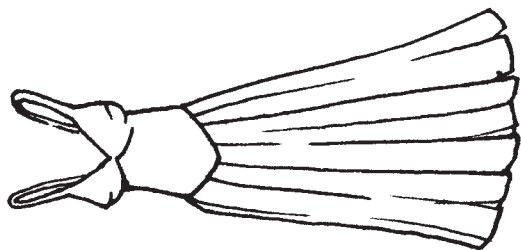

ŠATY (DAŇSKÉ)

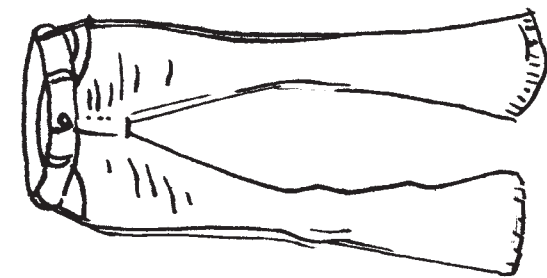

DŽÍNY

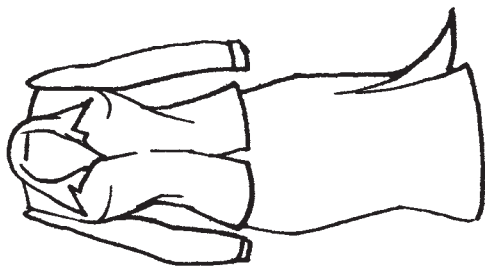

KOSTÝM

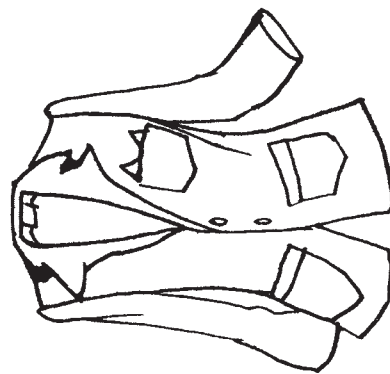

SAKO

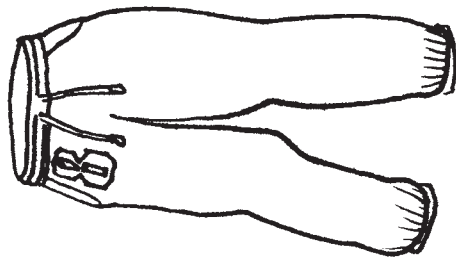

TEPLÁKY

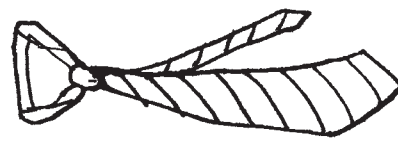

KRAVATA



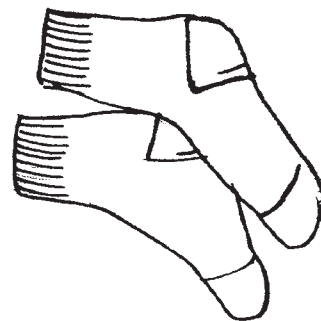
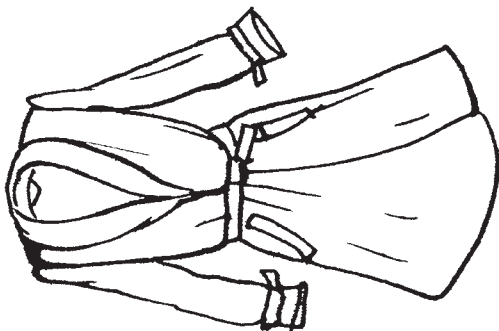
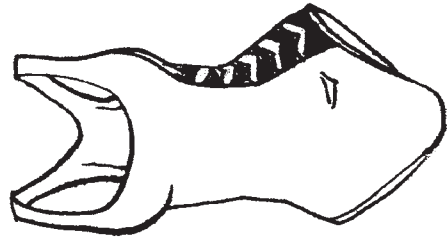
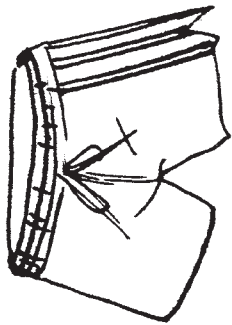
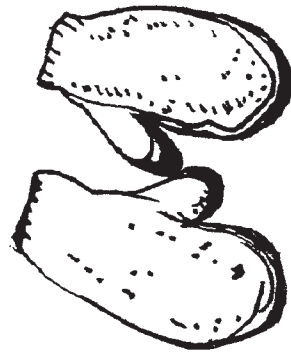
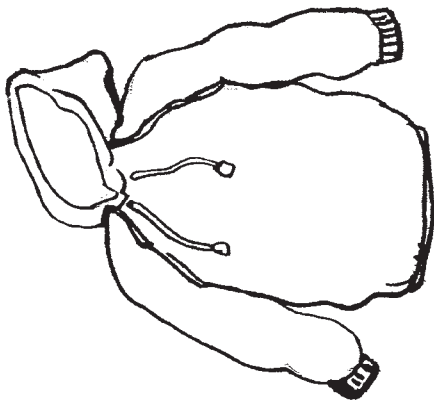

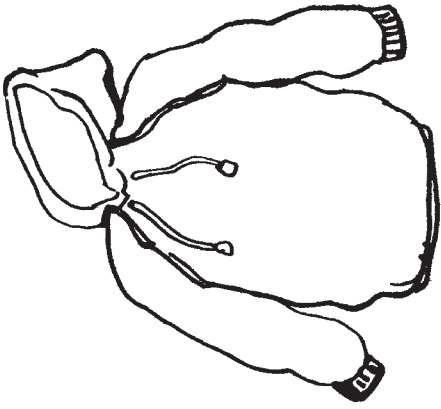

MIKINA

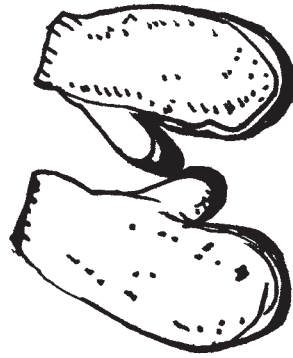

UKAVICE

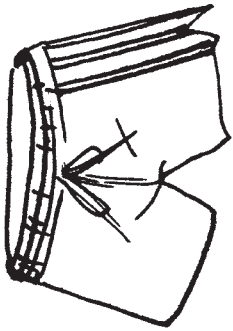

TRENÝRKY

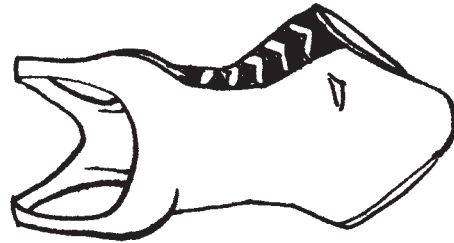

PLAVKY

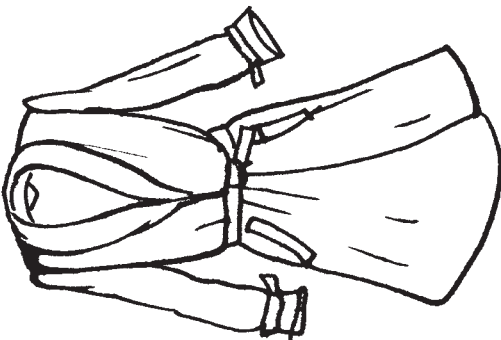

KABÁT

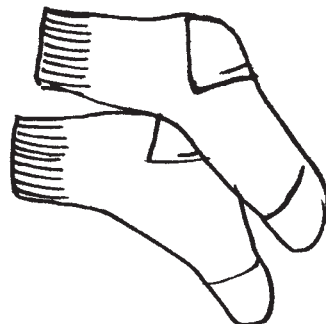

PONOŽKY

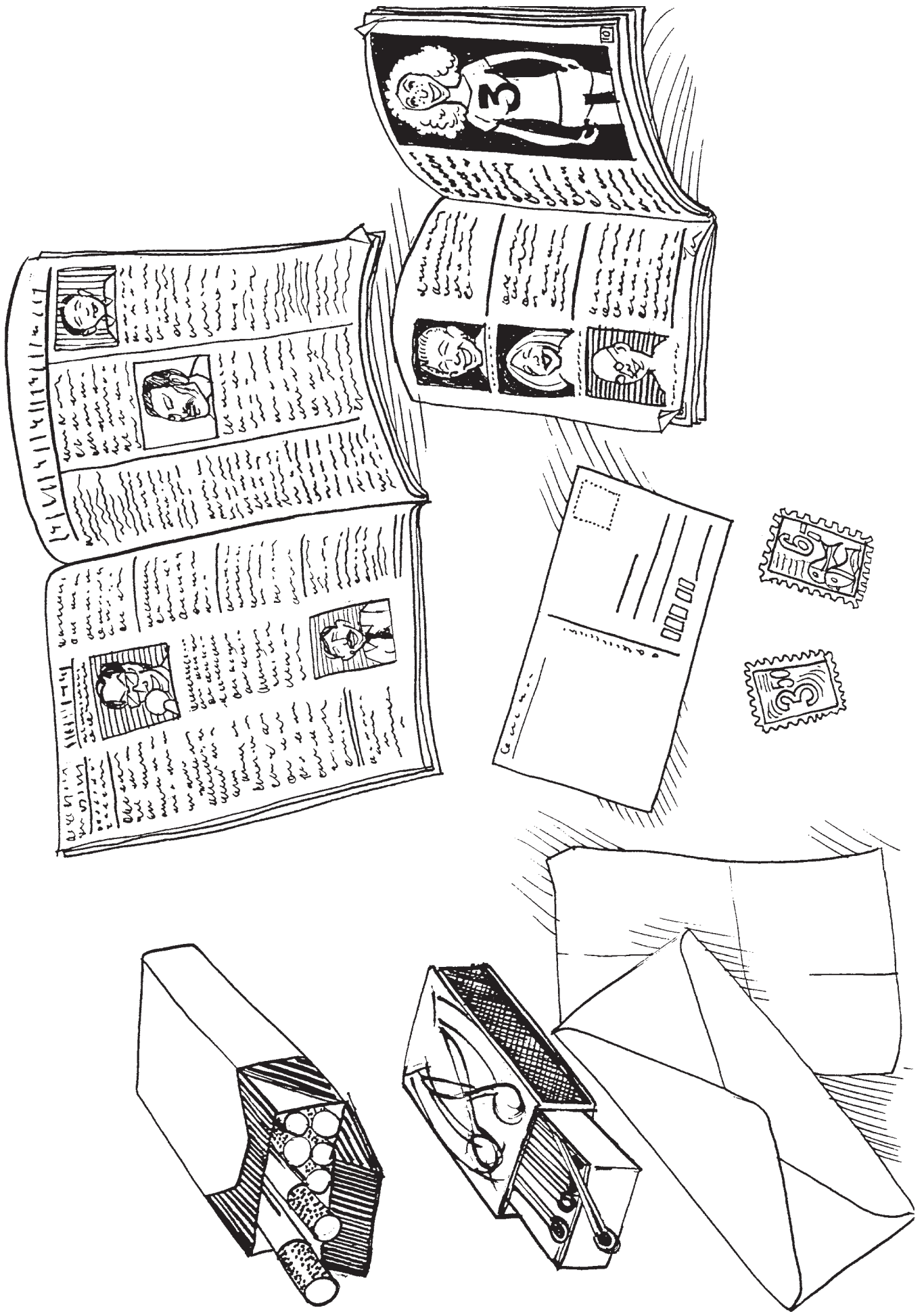

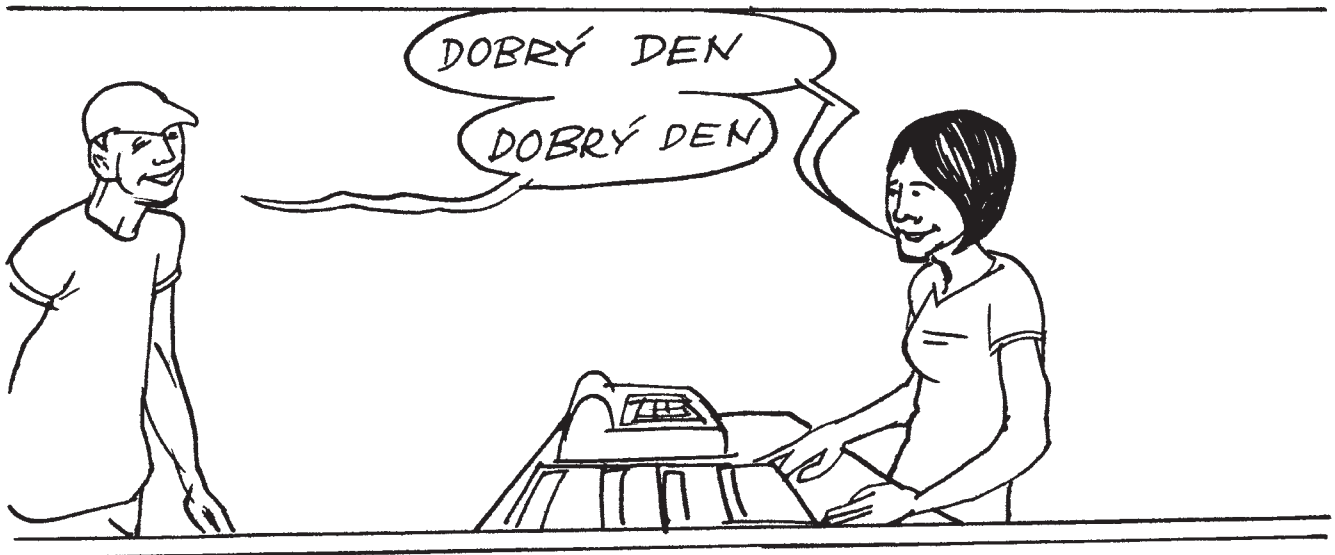

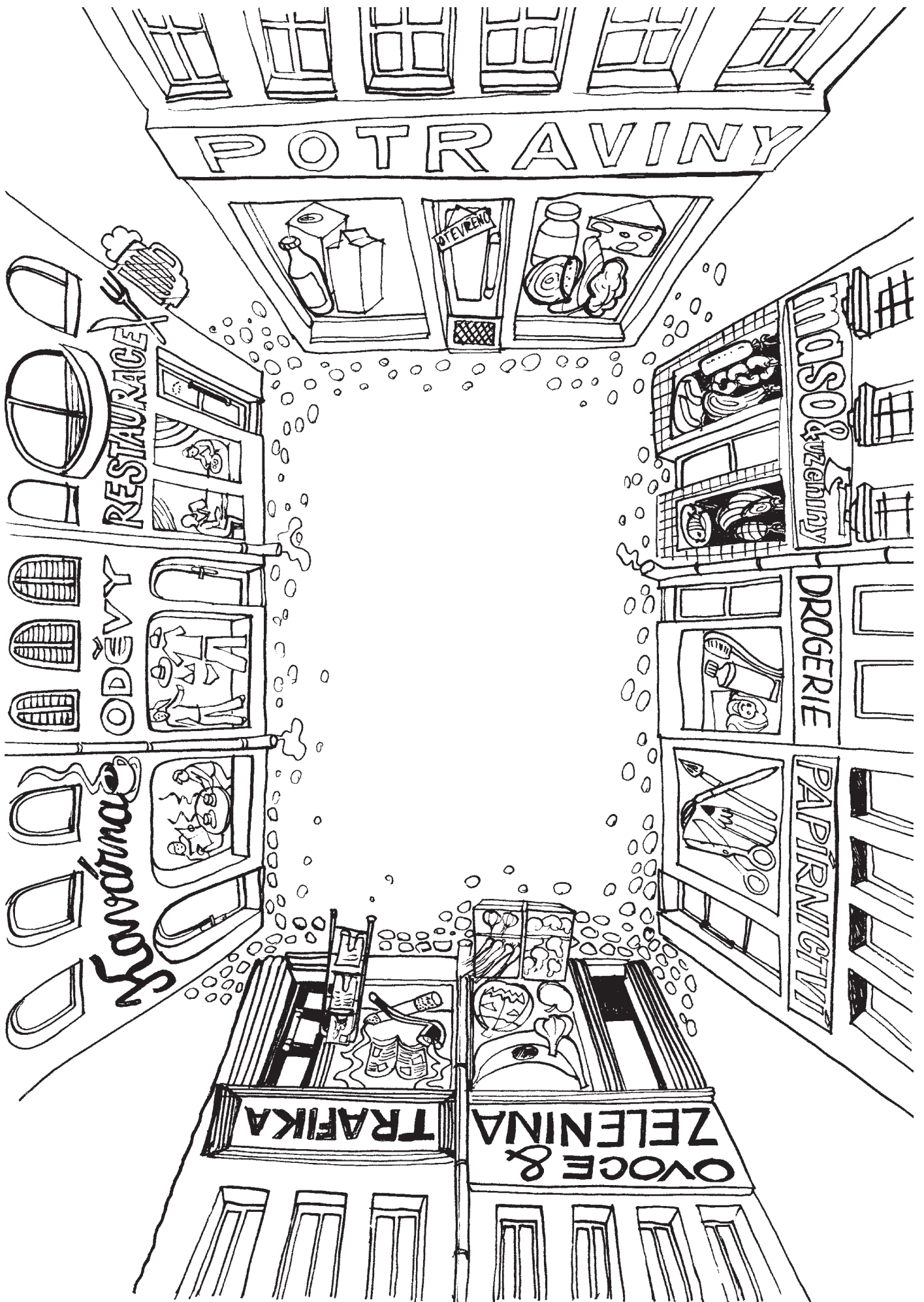

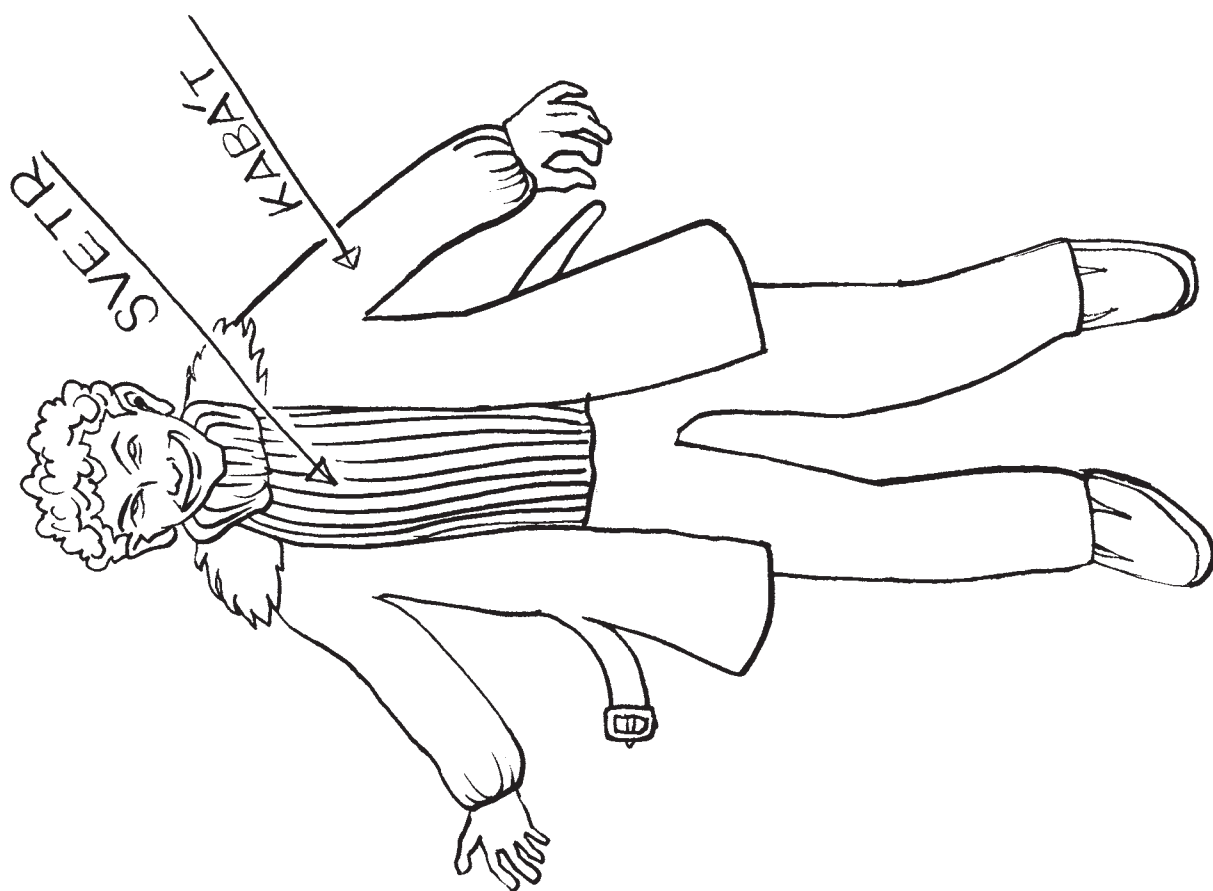

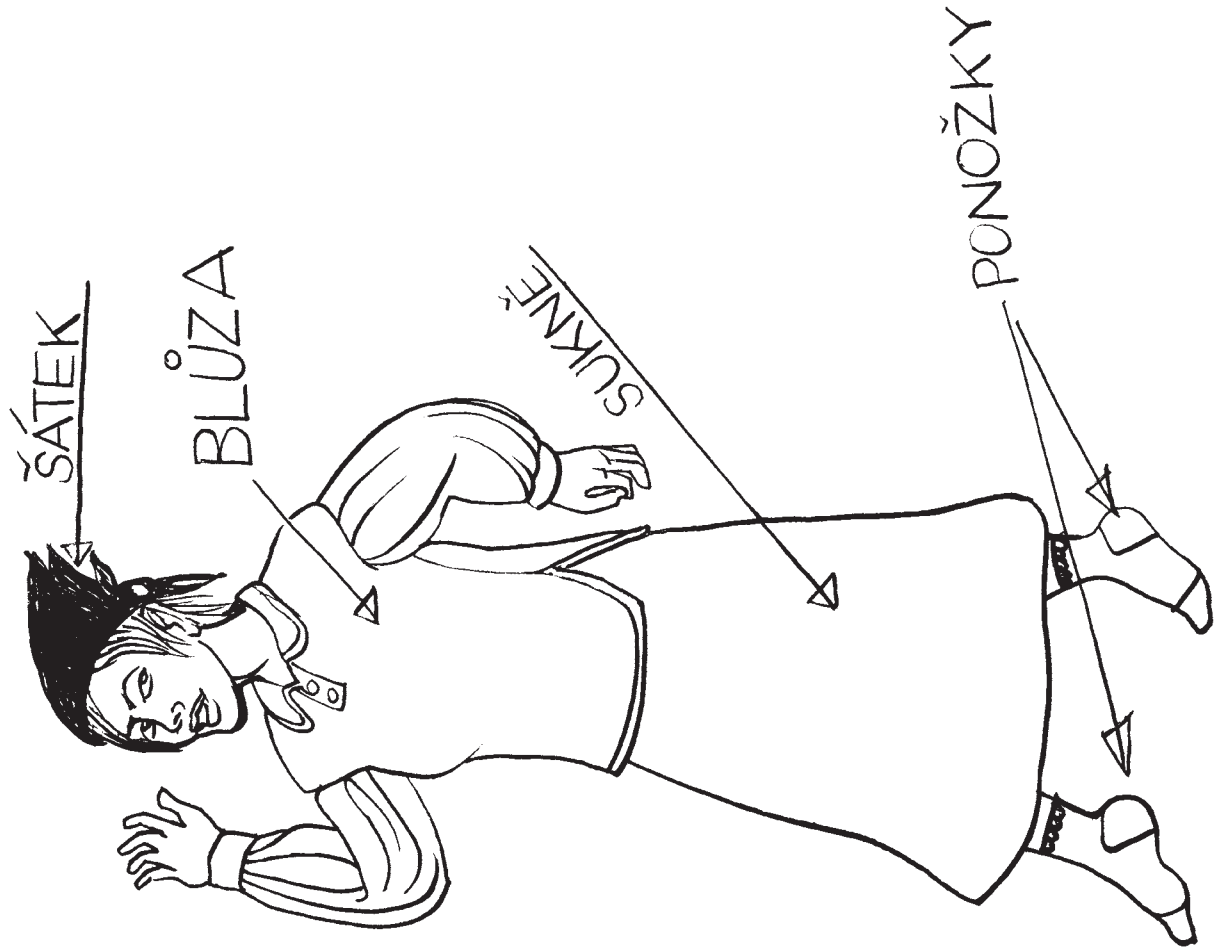
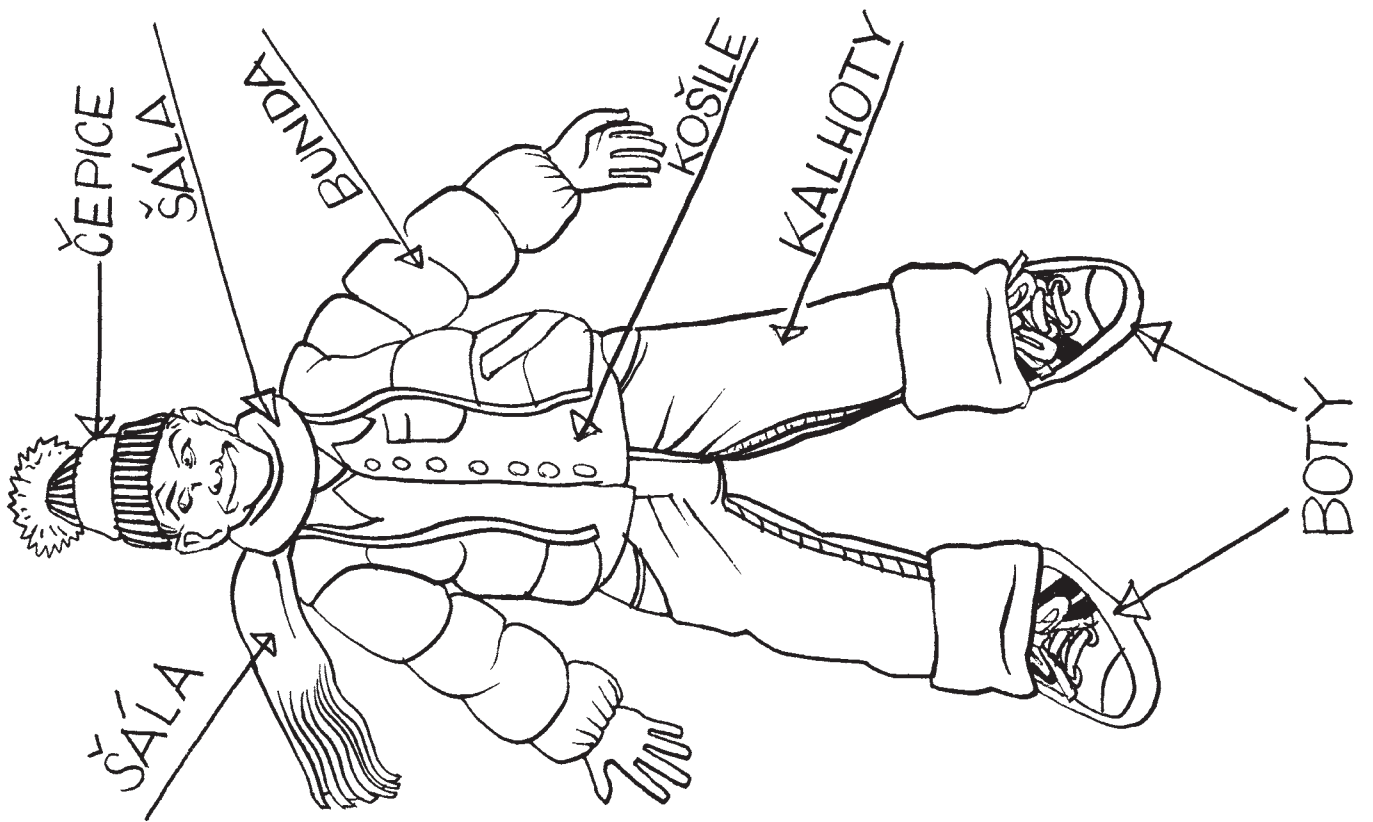



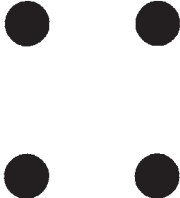
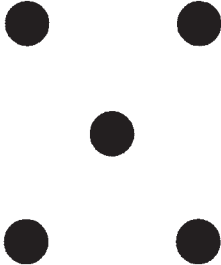
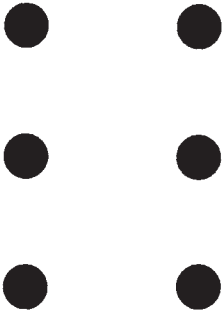
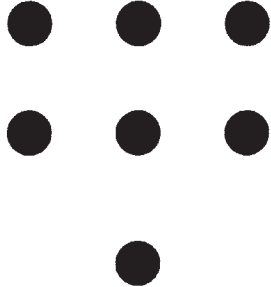
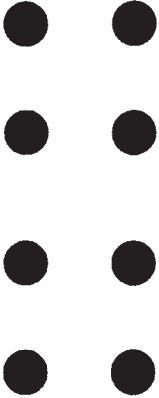
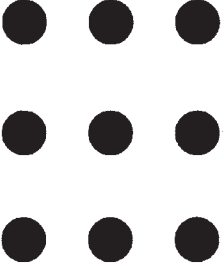

## BYDLET

JÁ	BYDLÍM
TY	BYDLÍŠ
ON, ONA, ONO	BYDLÍ
MY	BYDLÍME
VY	BYDLÍTE
ONI	BYDLÍ

## PRACOVAT

JÁ	PRACUJU
TY	PRACUJEŠ
ON, ONA, ONO	PRACUJE
MY	PRACUJEME
VY	PRACUJETE
ONI	PRACUJOU

## BYDLET

JÁ	BYDLÍM
TY	BYDLÍŠ
ON, ONA, ONO	BYDLÍ
MY	BYDLÍME
VY	BYDLÍTE
ONI	BYDLÍ

## PRACOVAT

JÁ	PRACUJU
TY	PRACUJEŠ
ON, ONA, ONO	PRACUJE
MY	PRACUJEME
VY	PRACUJETE
ONI	PRACUJOU

## BYDLET

JÁ	BYDLÍM
TY	BYDLÍŠ
ON, ONA, ONO	BYDLÍ
MY	BYDLÍME
VY	BYDLÍTE
ONI	BYDLÍ

## PRACOVAT

JÁ	PRACUJU
TY	PRACUJEŠ
ON, ONA, ONO	PRACUJE
MY	PRACUJEME
VY	PRACUJETE
ONI	PRACUJOU

MÍT		BYDLET		PRACOVAT	
mám	máme	bydlím	bydlíme	pracuju	pracujeme
máš	máte	bydlíš	bydlíte	pracuješ	pracujete
má	mají	bydlí	bydlí	pracuje	pracujou
znát, čekat		mluvit, rozumět		potřebovat, studovat	

MÍT		BYDLET		PRACOVAT	
mám	máme	bydlím	bydlíme	pracuju	pracujeme
máš	máte	bydlíš	bydlíte	pracuješ	pracujete
má	mají	bydlí	bydlí	pracuje	pracujou
znát, čekat		mluvit, rozumět		potřebovat, studovat	

MÍT		BYDLET		PRACOVAT	
mám	máme	bydlím	bydlíme	pracuju	pracujeme
máš	máte	bydlíš	bydlíte	pracuješ	pracujete
má	mají	bydlí	bydlí	pracuje	pracujou
znát, čekat		mluvit, rozumět		potřebovat, studovat	

MÍT		BYDLET		PRACOVAT	
mám	máme	bydlím	bydlíme	pracuju	pracujeme
máš	máte	bydlíš	bydlíte	pracuješ	pracujete
má	mají	bydlí	bydlí	pracuje	pracujou
znát, čekat		mluvit, rozumět		potřebovat, studovat	

MÍT		BYDLET		PRACOVAT	
mám	máme	bydlím	bydlíme	pracuju	pracujeme
máš	máte	bydlíš	bydlíte	pracuješ	pracujete
má	mají	bydlí	bydlí	pracuje	pracujou
znát, čekat		mluvit, rozumět		potřebovat, studovat	

MÍT		BYDLET		PRACOVAT	
mám	máme	bydlím	bydlíme	pracuju	pracujeme
máš	máte	bydlíš	bydlíte	pracuješ	pracujete
má	mají	bydlí	bydlí	pracuje	pracujou
znát, čekat		mluvit, rozumět		potřebovat, studovat	

pošta → Pan Novák je **na** poště.

stůl → Kniha je **na** stole.

	Kde je ...?
židle	Kniha je .....
policie	Pan Novák je .....
restaurace	Pan Novák je .....
tabule	Papír je .....
okno	Kniha je .....
taška	Kniha je .....
auto	Pan Novák je .....
nádraží	Pan Novák je .....
škola	Pan Novák je .....
obchod	Pan Novák je .....
nemocnice	Pan Novák je .....
autobus	Pan Novák je .....
práce	Pan Novák je .....
lékárna	Pan Novák je .....
výlet	Pan Novák je .....
náměstí	Pan Novák je .....
banka	Pan Novák je .....
oběd	Pan Novák je .....
snídaně	Pan Novák je .....

banka	v bance
lékárna	v lékárně
škola	ve škole
Praha	v Praze
pošta	na poště
univerzita	na univerzitě
obchod	v obchodě
autobus	v autobuse
stůl	na stole
město	ve městě
auto	v autě
Brno	v Brně
drogerie	v drogerii
restaurace	v restauraci
policie	na policii
práce	v práci
nádraží	na nádraží
náměstí	na náměstí
park	v parku
hotel	v hotelu

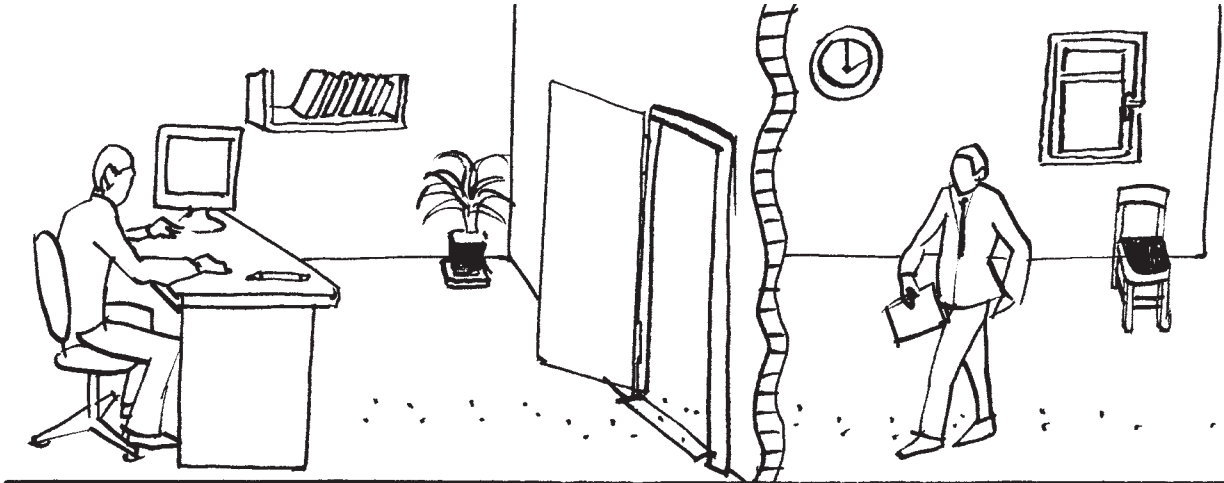

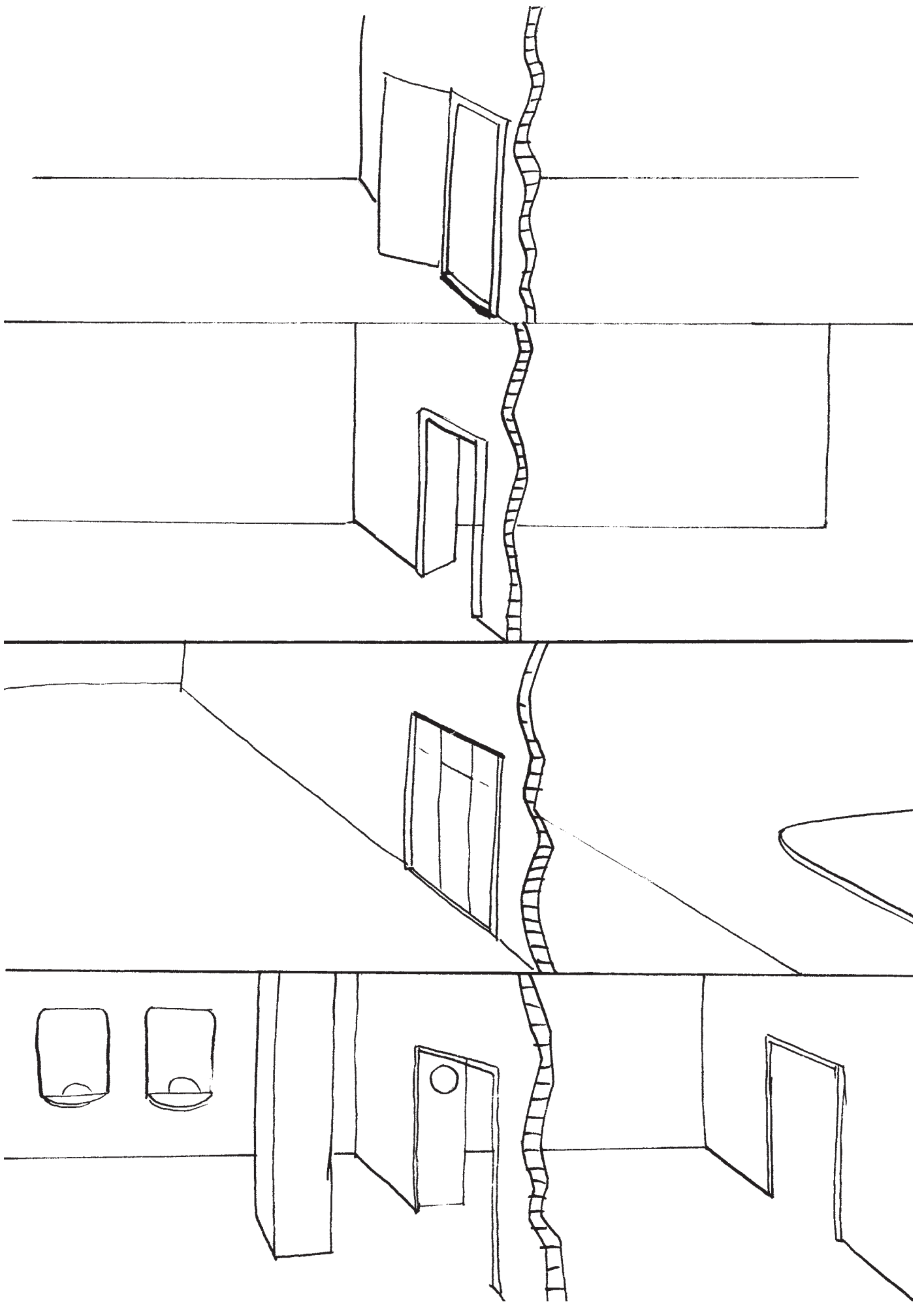

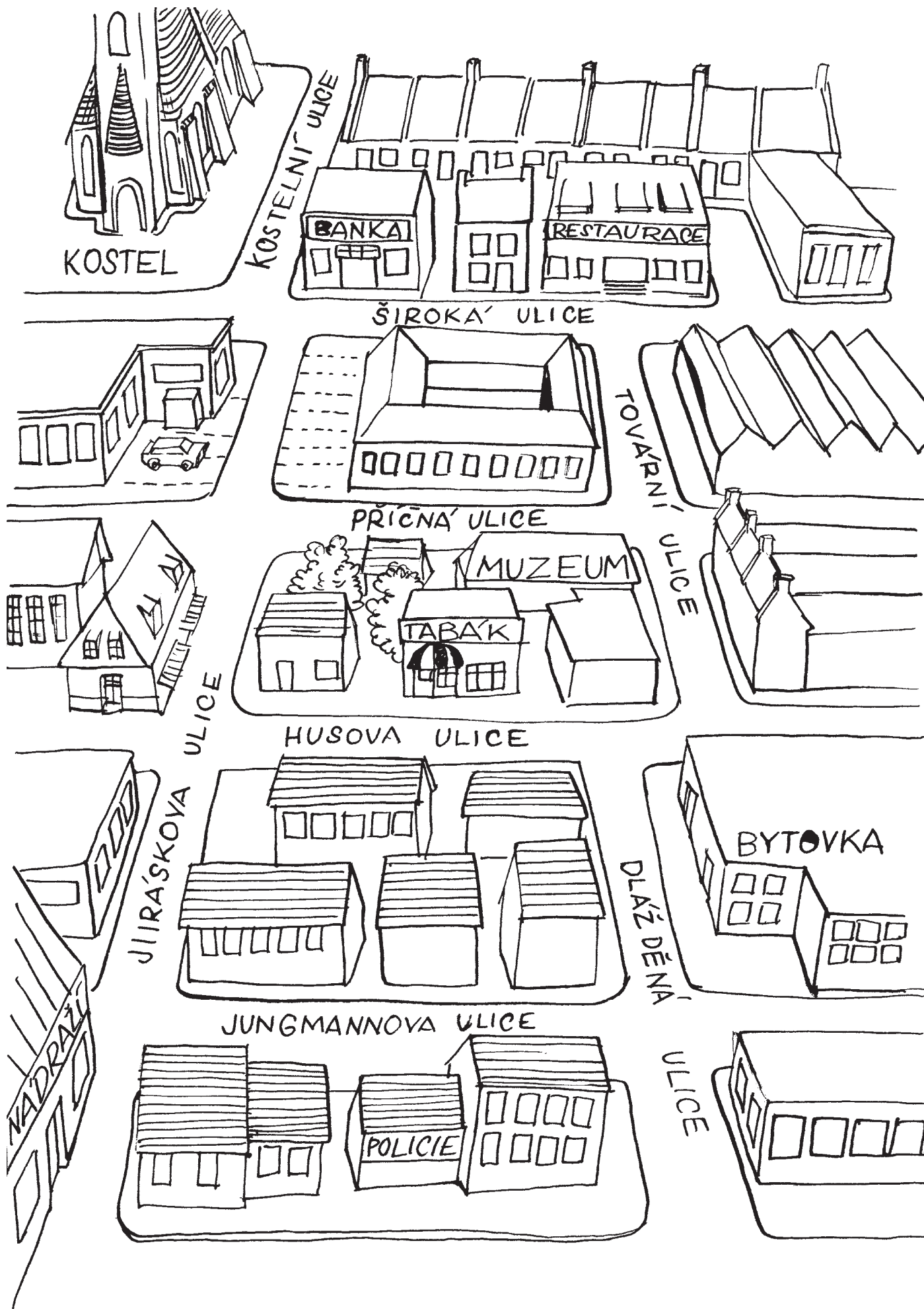

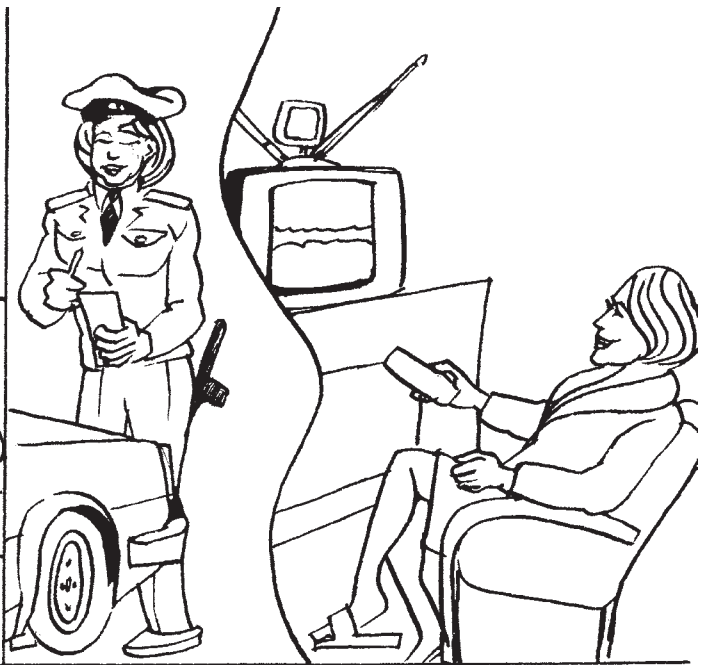
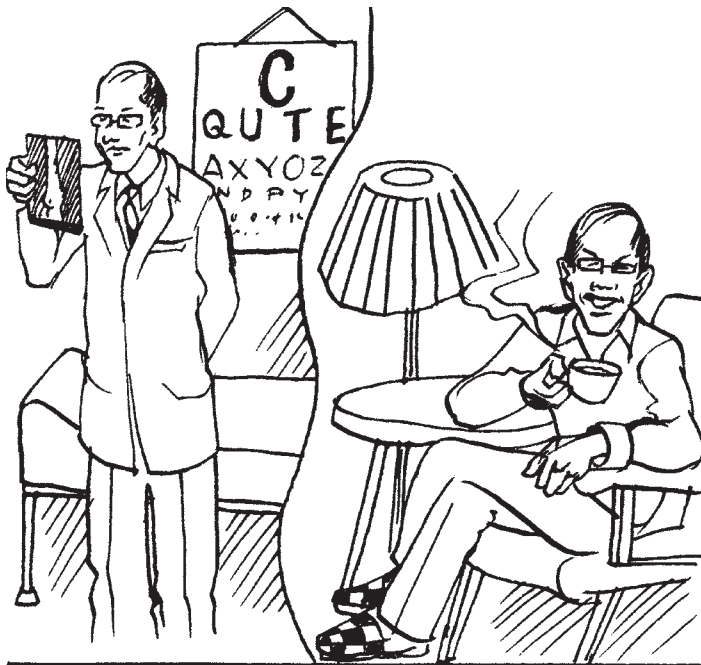



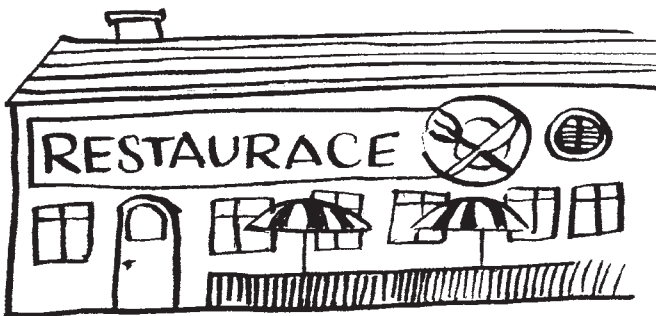
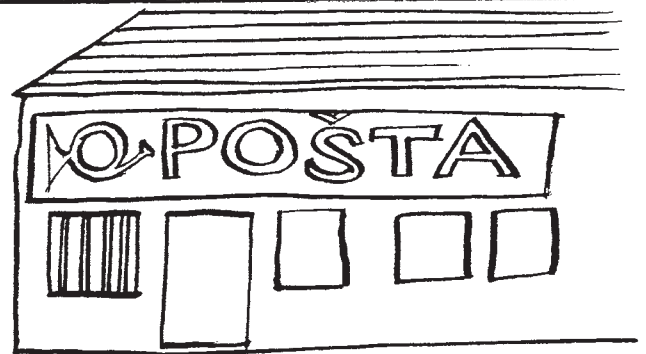
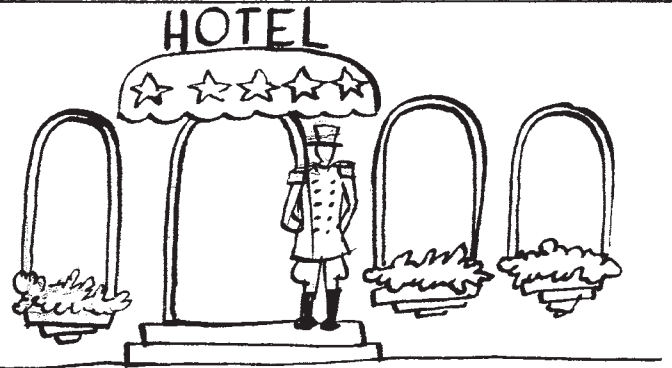
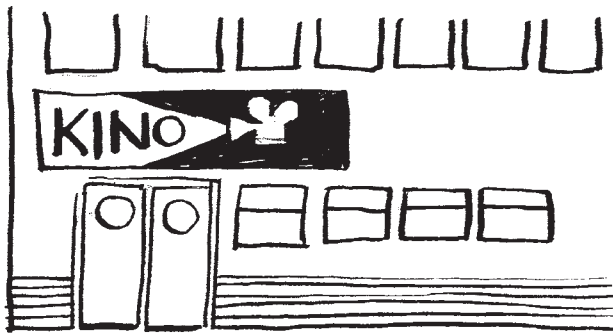
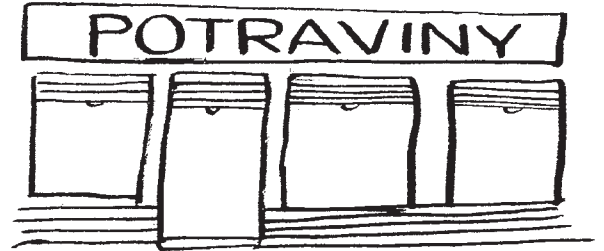
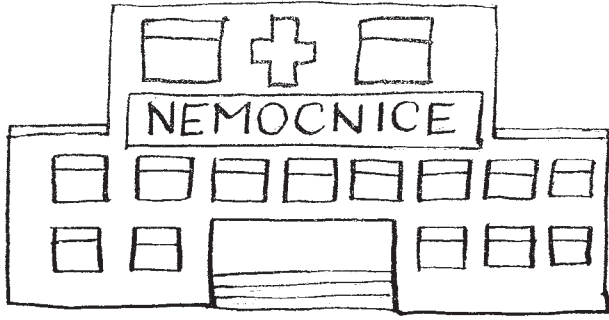

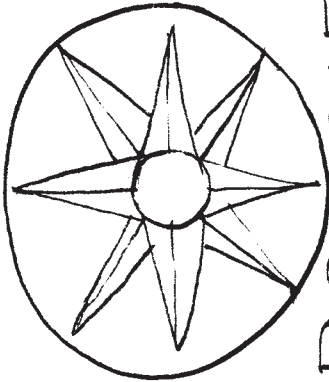
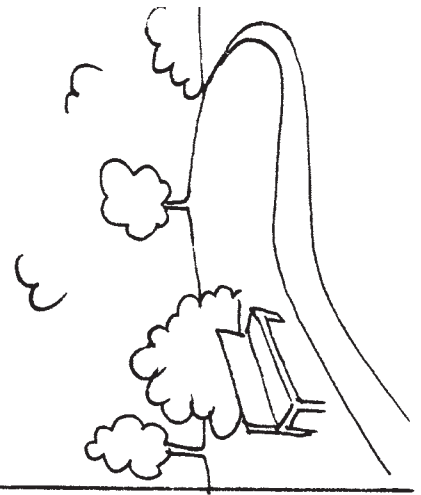
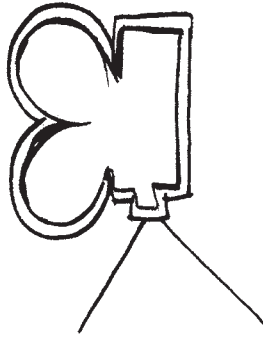
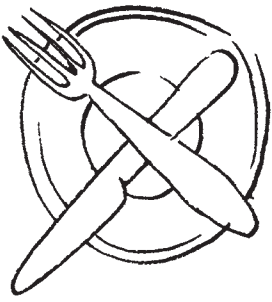

POLICIE

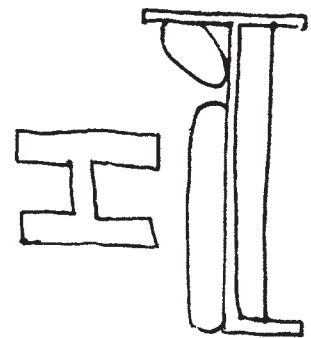
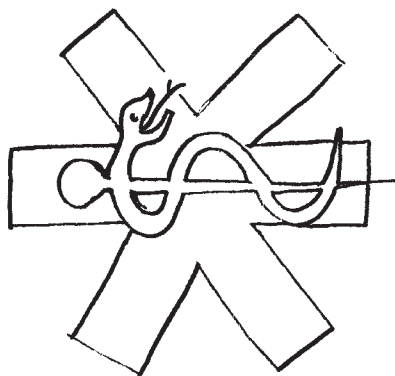
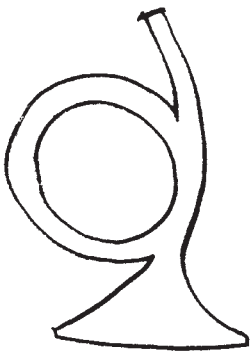
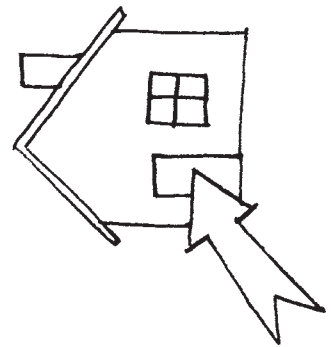
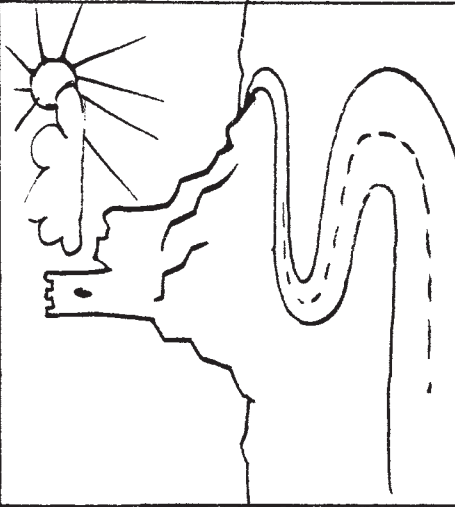
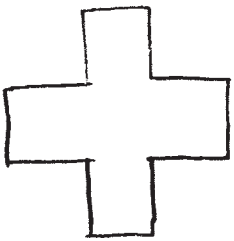
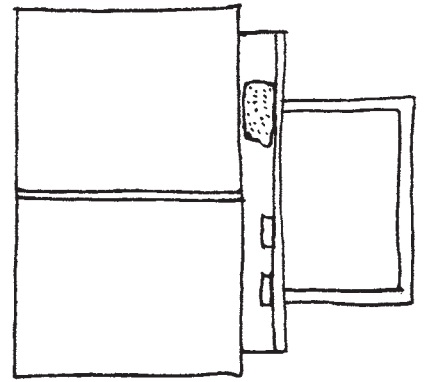
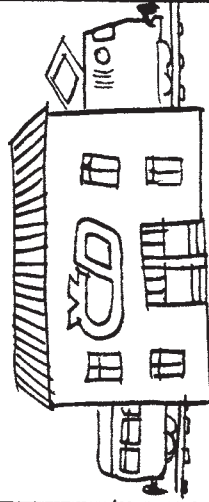



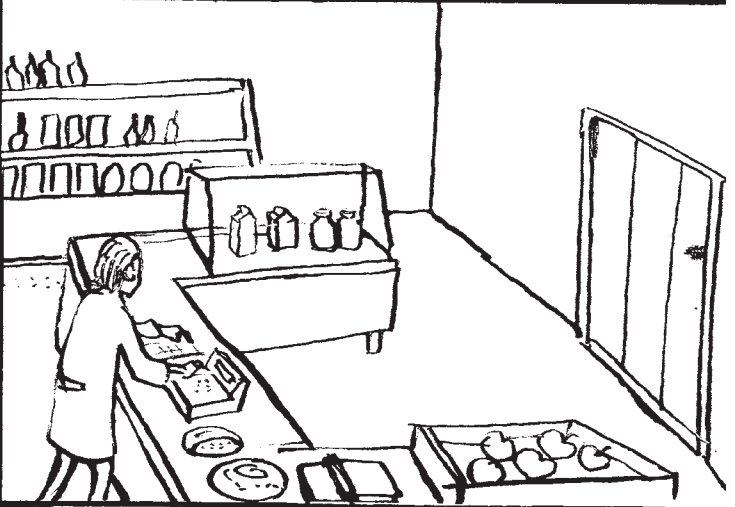
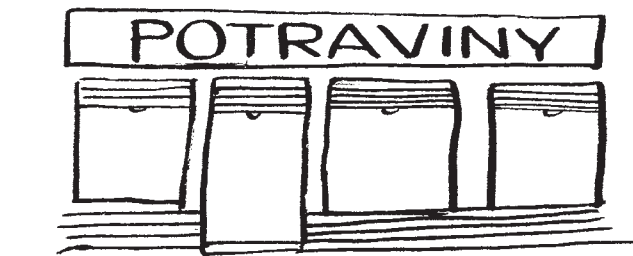
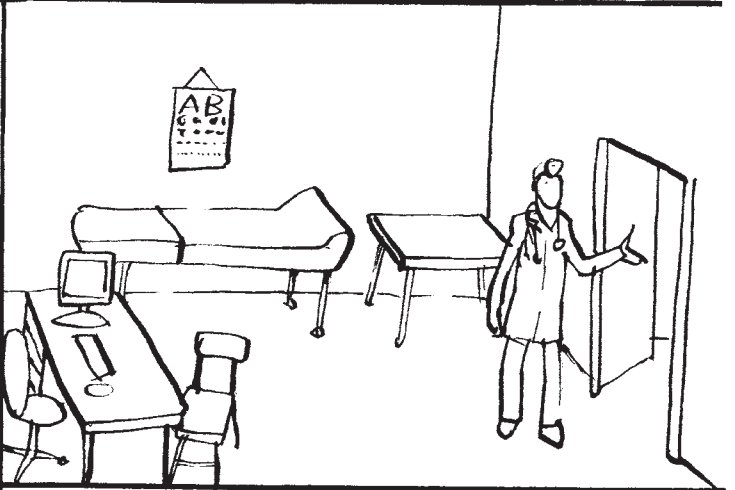
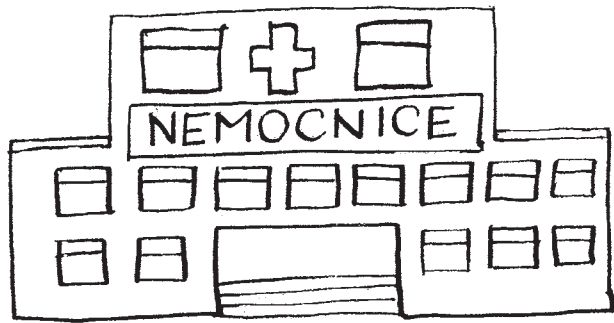

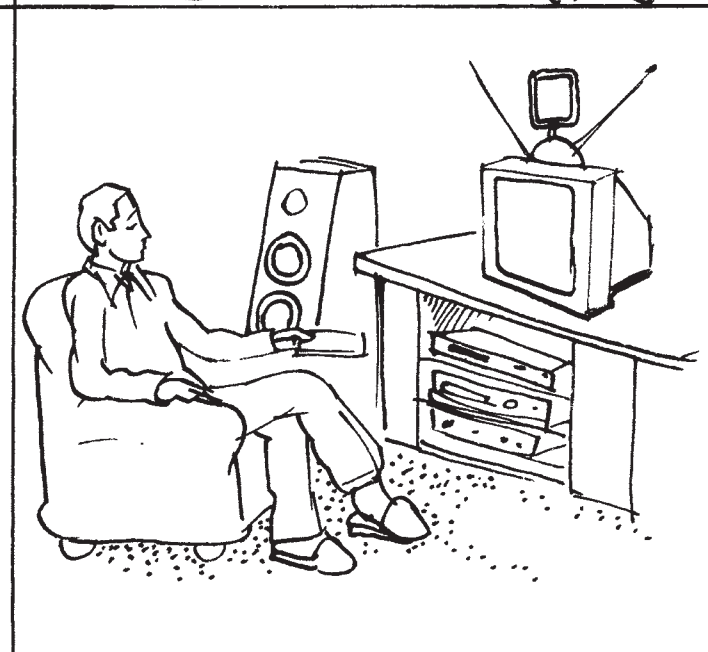
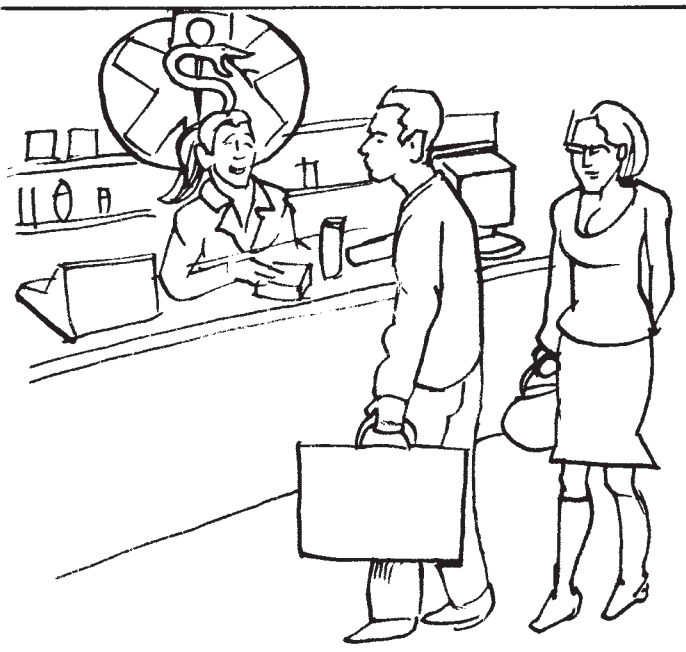
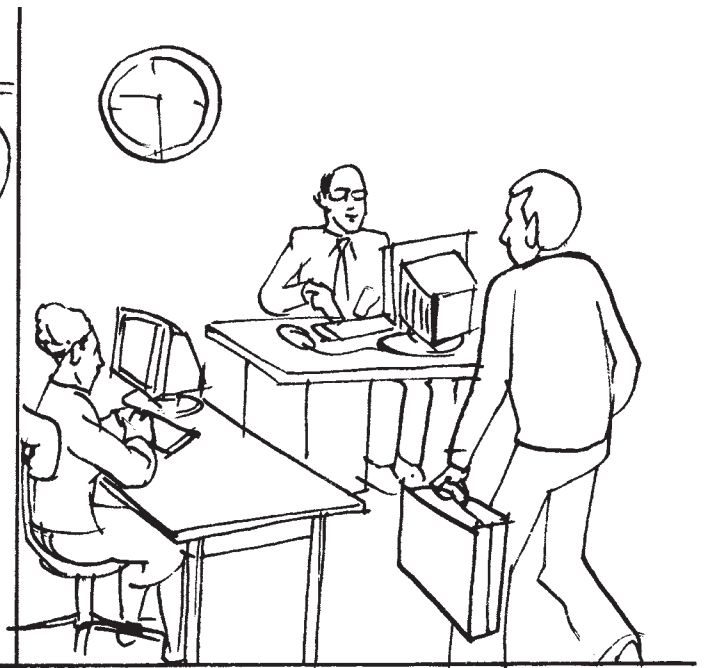
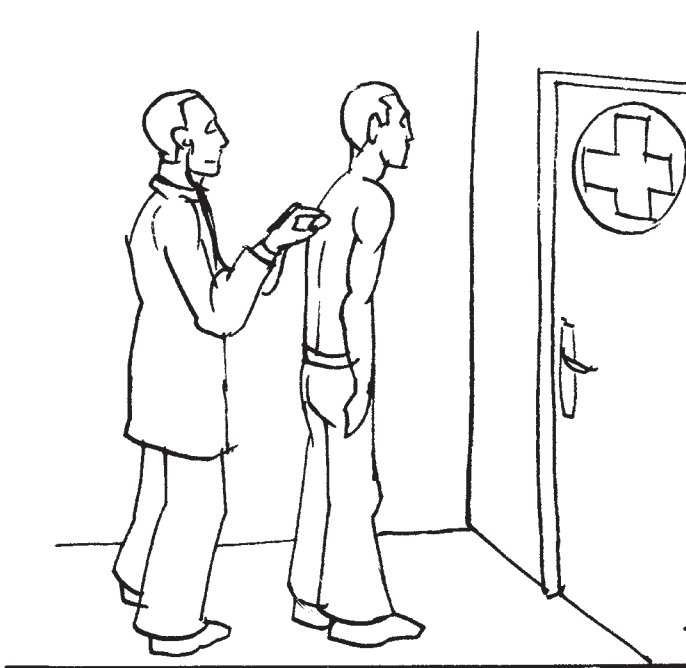



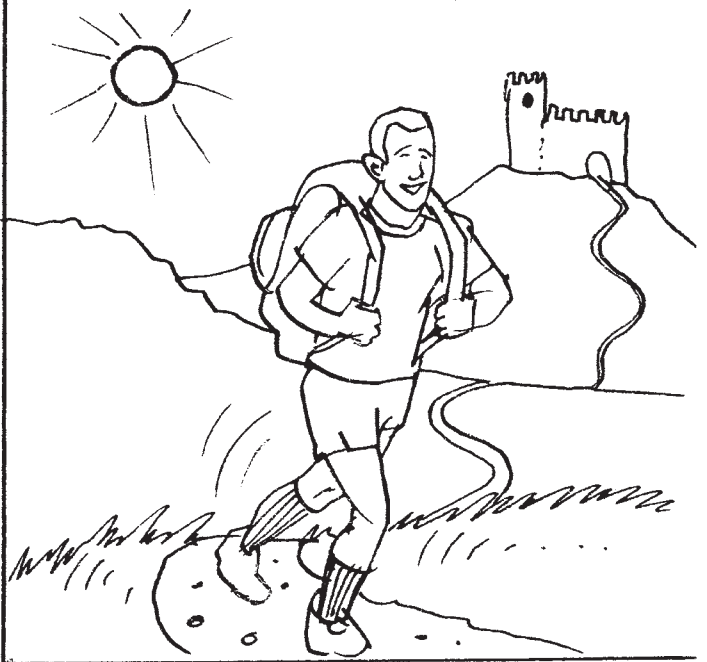

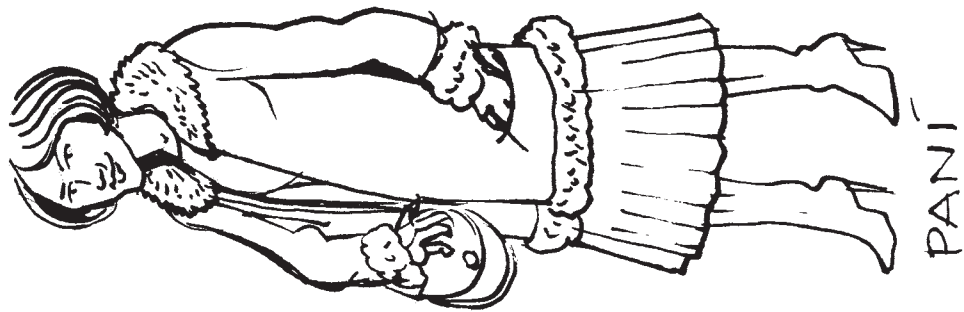

PANI

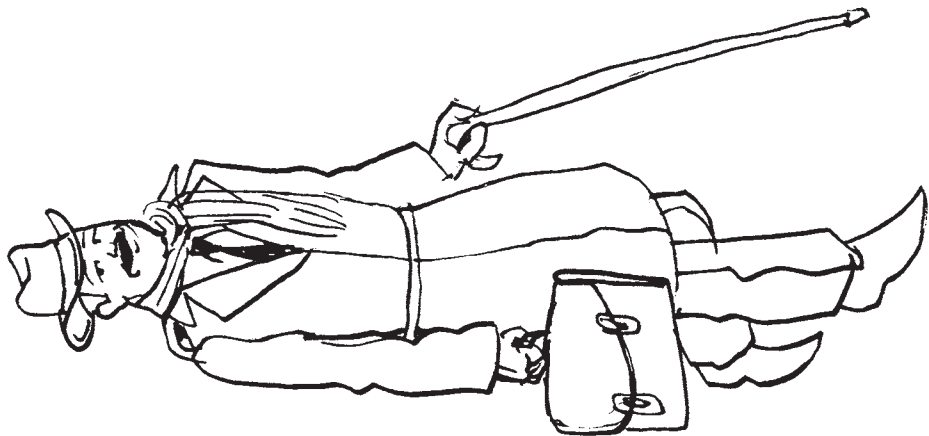

PA'N

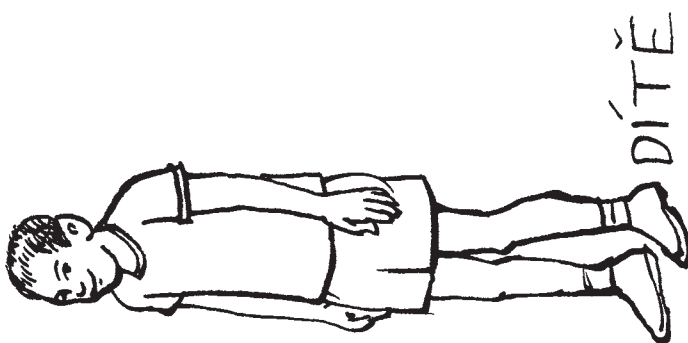

DITÈ

**Časování sloves bydlet, pracovat a potřebovat:**

(já) <b>bydlím</b>	
(ty) <b>bydlíš</b>	(vy) <b>bydlíte</b>
(on, ona) <b>bydlí</b>	

(já) <b>pracuju</b>		(já) <b>potřebuju</b>	
(ty) <b>pracuješ</b>	(vy) <b>pracujete</b>	(ty) <b>potřebuješ</b>	(vy) <b>potřebujete</b>
(on, ona) <b>pracuje</b>		(on, ona) <b>potřebuje</b>	

**Časování sloves bydlet, pracovat a potřebovat:**

(já) <b>bydlím</b>	
(ty) <b>bydlíš</b>	(vy) <b>bydlíte</b>
(on, ona) <b>bydlí</b>	

(já) <b>pracuju</b>		(já) <b>potřebuju</b>	
(ty) <b>pracuješ</b>	(vy) <b>pracujete</b>	(ty) <b>potřebuješ</b>	(vy) <b>potřebujete</b>
(on, ona) <b>pracuje</b>		(on, ona) <b>potřebuje</b>	



1:30	2:15
3:45	4:50
5:25	6:10
7:20	8:35
9:15	10:45
11:55	12:05

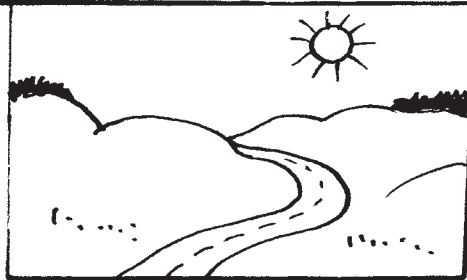
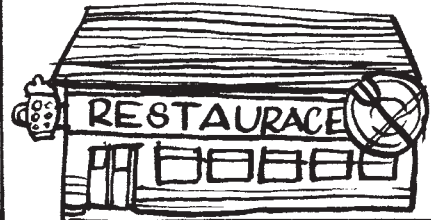
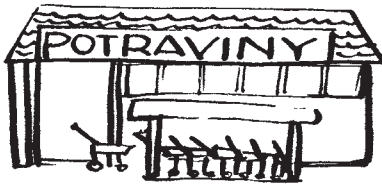
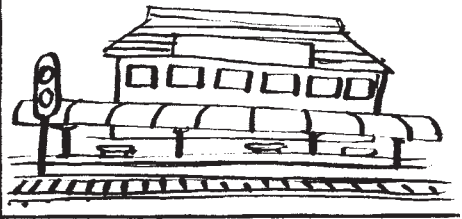
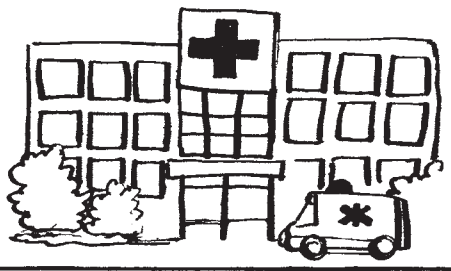
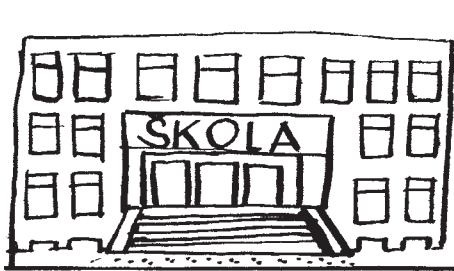

PO	
UT	
ST	
ČT	
PÁ'	
SO	
NE	

PO

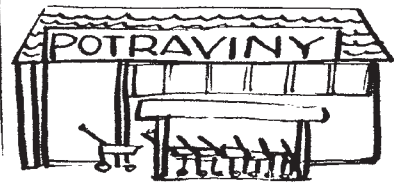
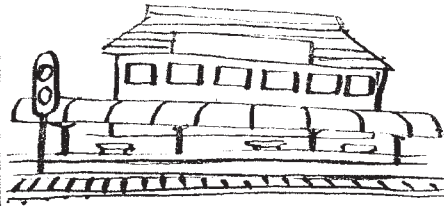

UT

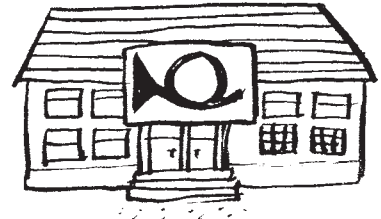

ST

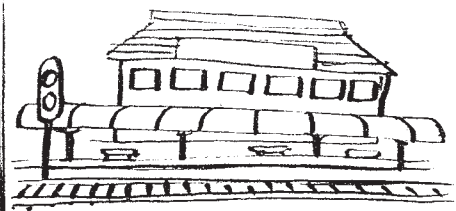
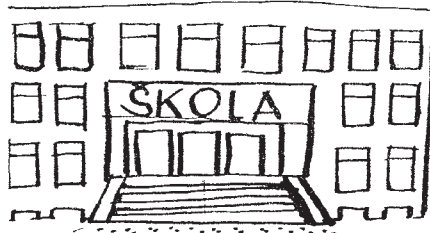

ČT

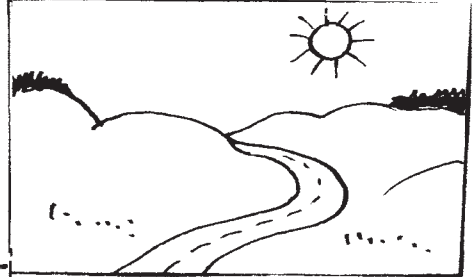
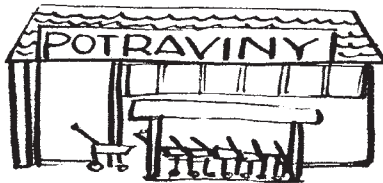

PÁ

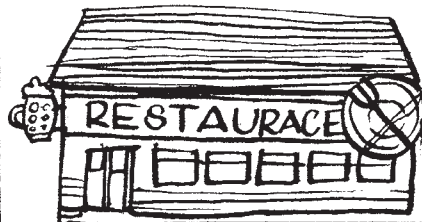

SO

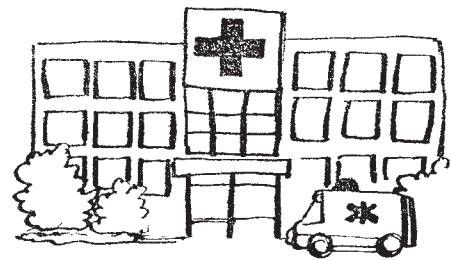
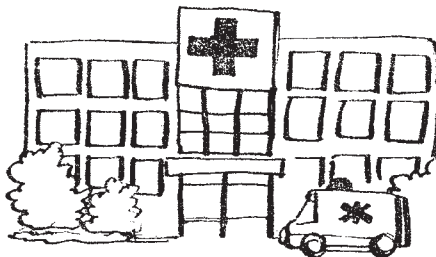

NE

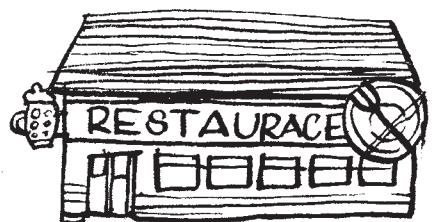
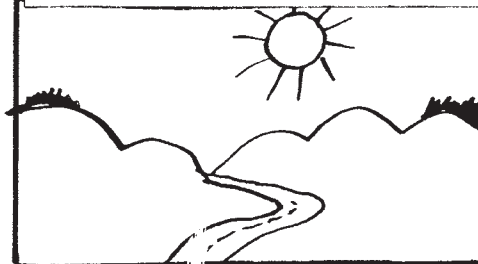

PO



UT

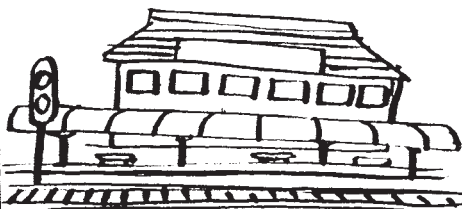

ST

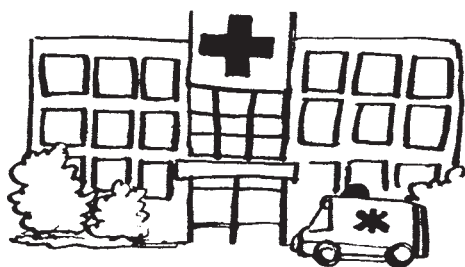

ČT



PÁ



SO



NE

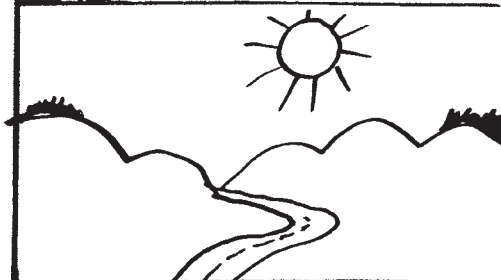

PO

9:00



20:00



UT

16:00

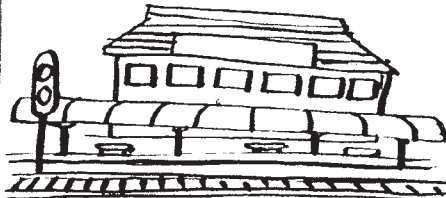

11:00



ST

15:00

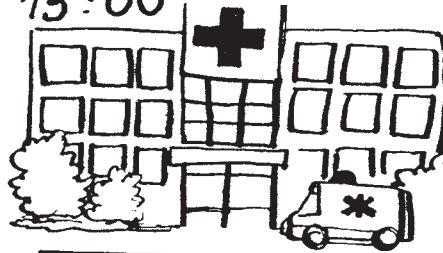

10:00

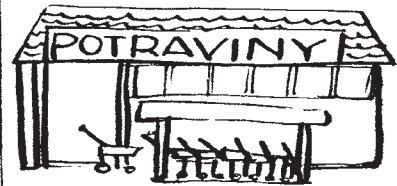

ČT

17:00



8:00



PÁ

13:00

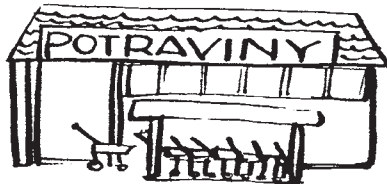

7:00



SO

12:00



14:00

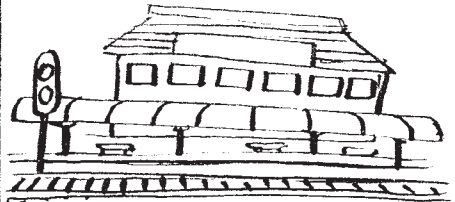

NE

18:00



17:00

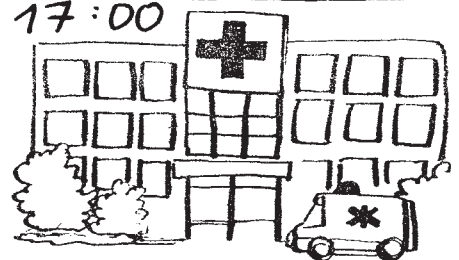



PO

UT

ST

ČT

PÁ

SO

NE

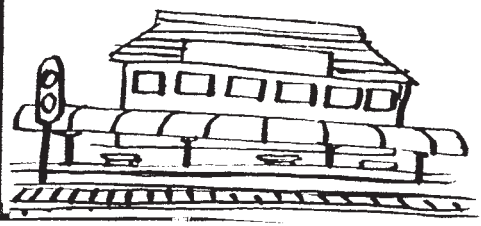
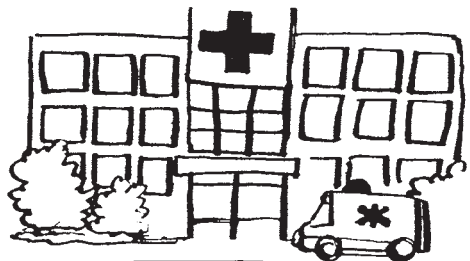
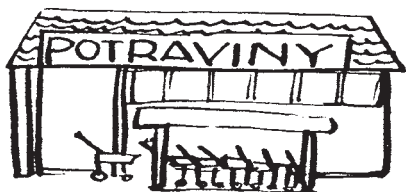



PO

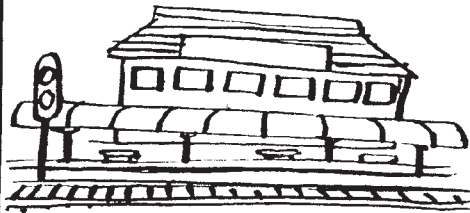

UT

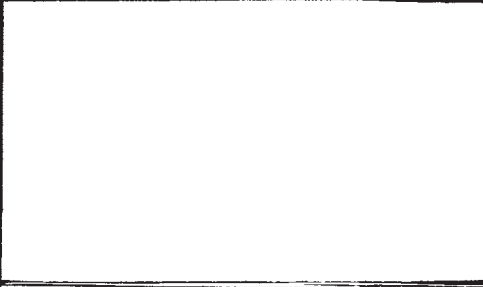

ST



ČT

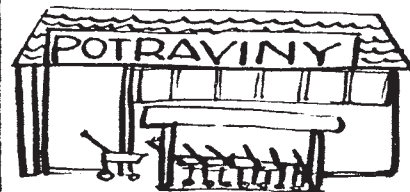

PÁ

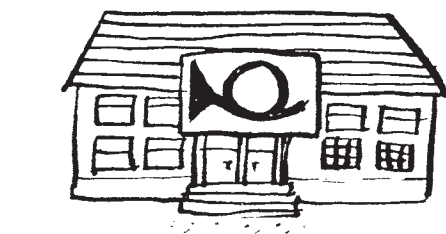

SO

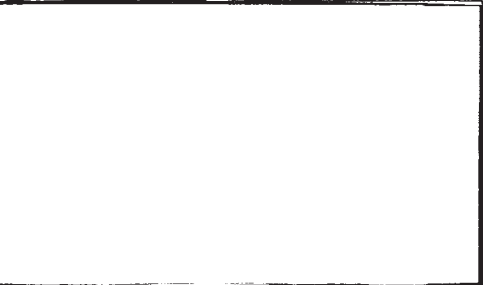

NE

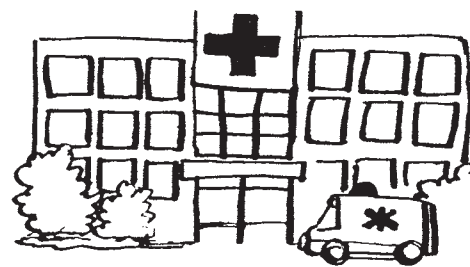









Časování slovesa *být* v minulém čase

(já)	<b>jsem byl / byla</b>	
(ty)	<b>jsi byl / byla</b>	(vy) <b>jste byli</b>
(on, ona)	<b>byl / byla</b>	

Časování slovesa *být* v minulém čase

(já)	<b>jsem byl / byla</b>	
(ty)	<b>jsi byl / byla</b>	(vy) <b>jste byli</b>
(on, ona)	<b>byl / byla</b>	

Časování slovesa *být* v minulém čase

(já)	<b>jsem byl / byla</b>	
(ty)	<b>jsi byl / byla</b>	(vy) <b>jste byli</b>
(on, ona)	<b>byl / byla</b>	

ČÍST

PSÁT

PÍT

JÁ	ČTU	PÍŠU	PIJU
TY	ČTEŠ	PÍŠEŠ	PIJEŠ
ON, ONA, ONO	ČTE	PÍŠE	PIJE
MY	ČTEME	PÍŠEME	PIJEME
VY	ČTETE	PÍŠETE	PIJETE
ONI	ČTOU	PÍŠOU	PIJOU

ČÍST

PSÁT

PÍT

JÁ	ČTU	PÍŠU	PIJU
TY	ČTEŠ	PÍŠEŠ	PIJEŠ
ON, ONA, ONO	ČTE	PÍŠE	PIJE
MY	ČTEME	PÍŠEME	PIJEME
VY	ČTETE	PÍŠETE	PIJETE
ONI	ČTOU	PÍŠOU	PIJOU

ČÍST

PSÁT

PÍT

JÁ	ČTU	PÍŠU	PIJU
TY	ČTEŠ	PÍŠEŠ	PIJEŠ
ON, ONA, ONO	ČTE	PÍŠE	PIJE
MY	ČTEME	PÍŠEME	PIJEME
VY	ČTETE	PÍŠETE	PIJETE
ONI	ČTOU	PÍŠOU	PIJOU

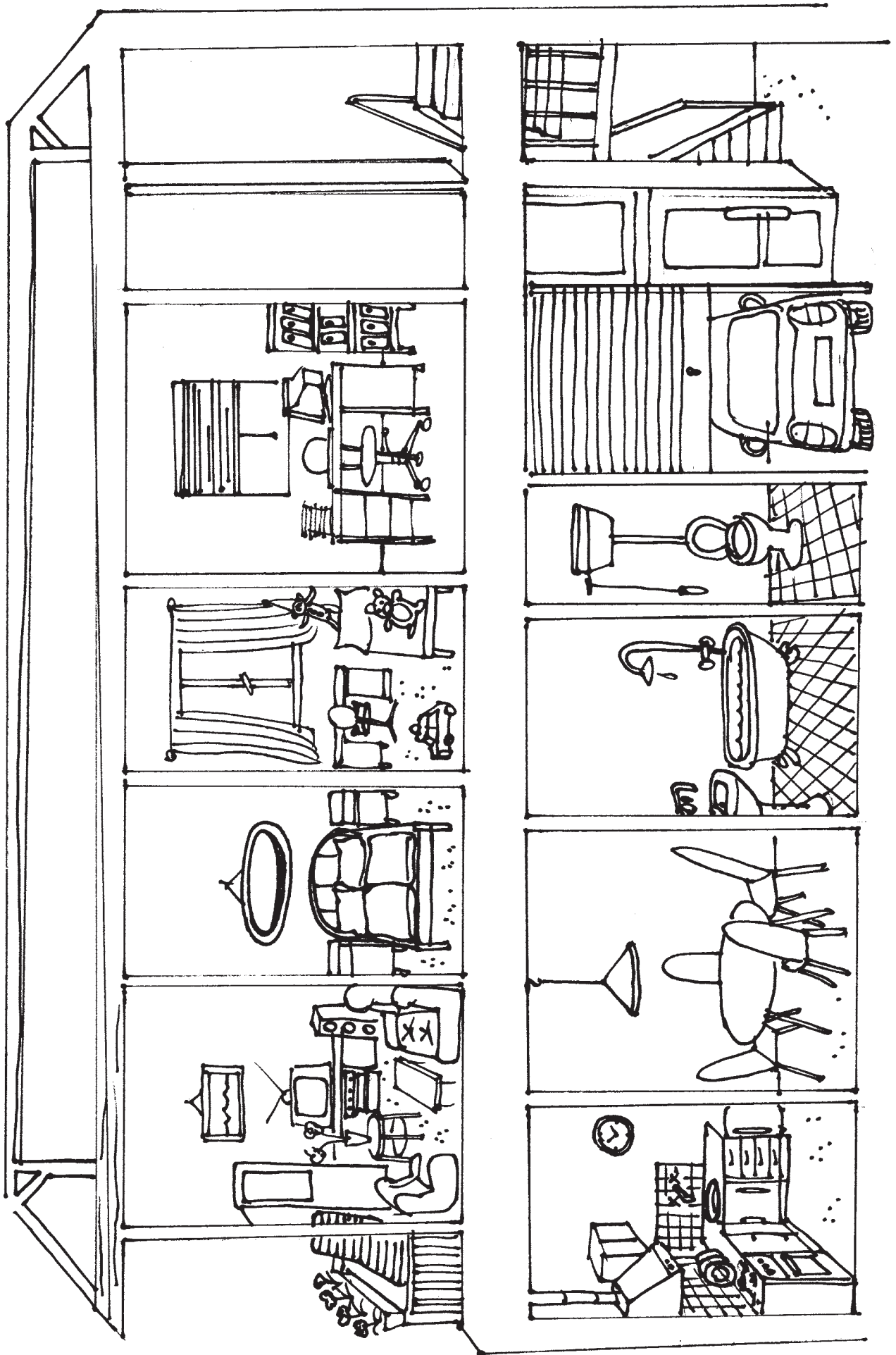



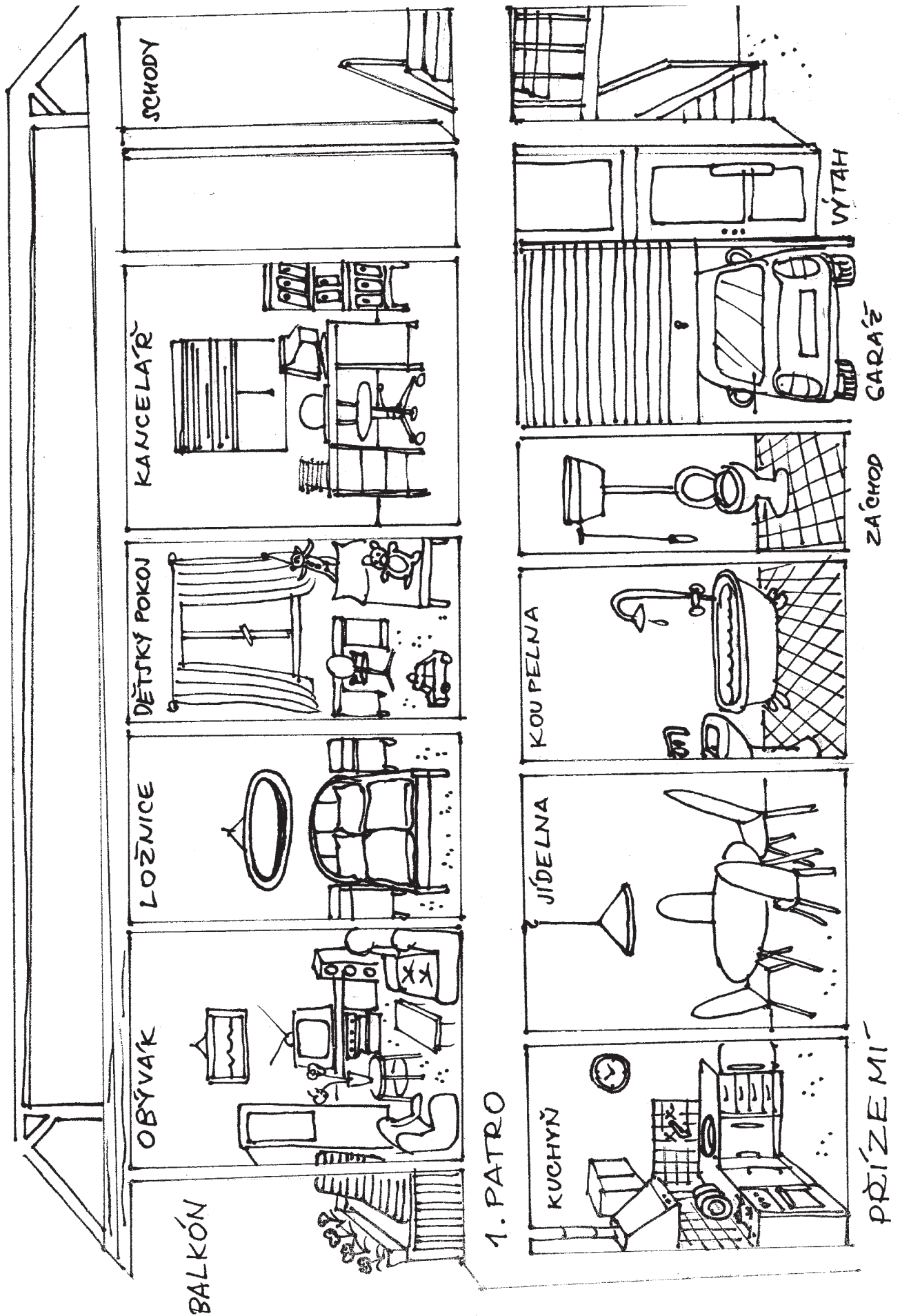

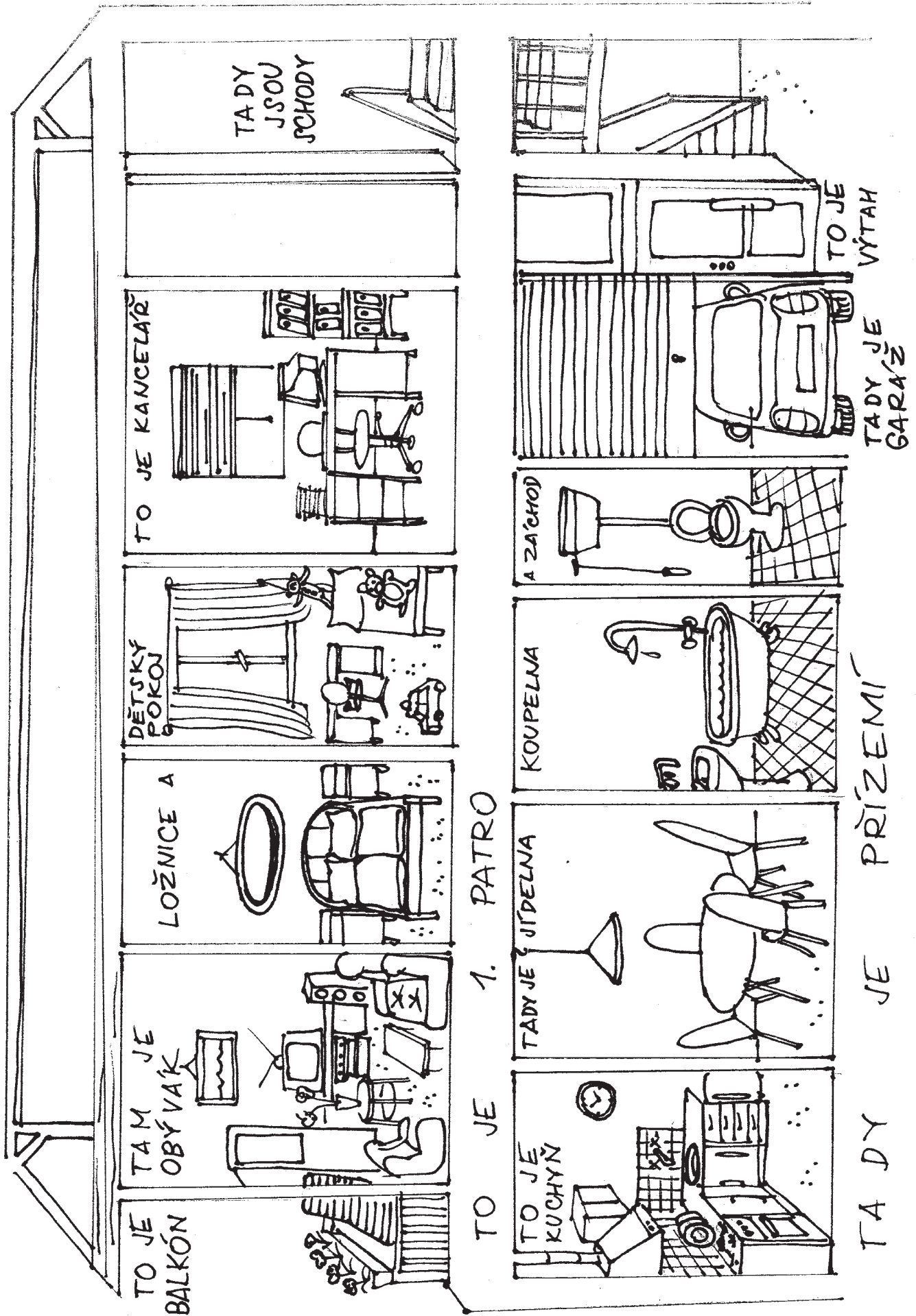

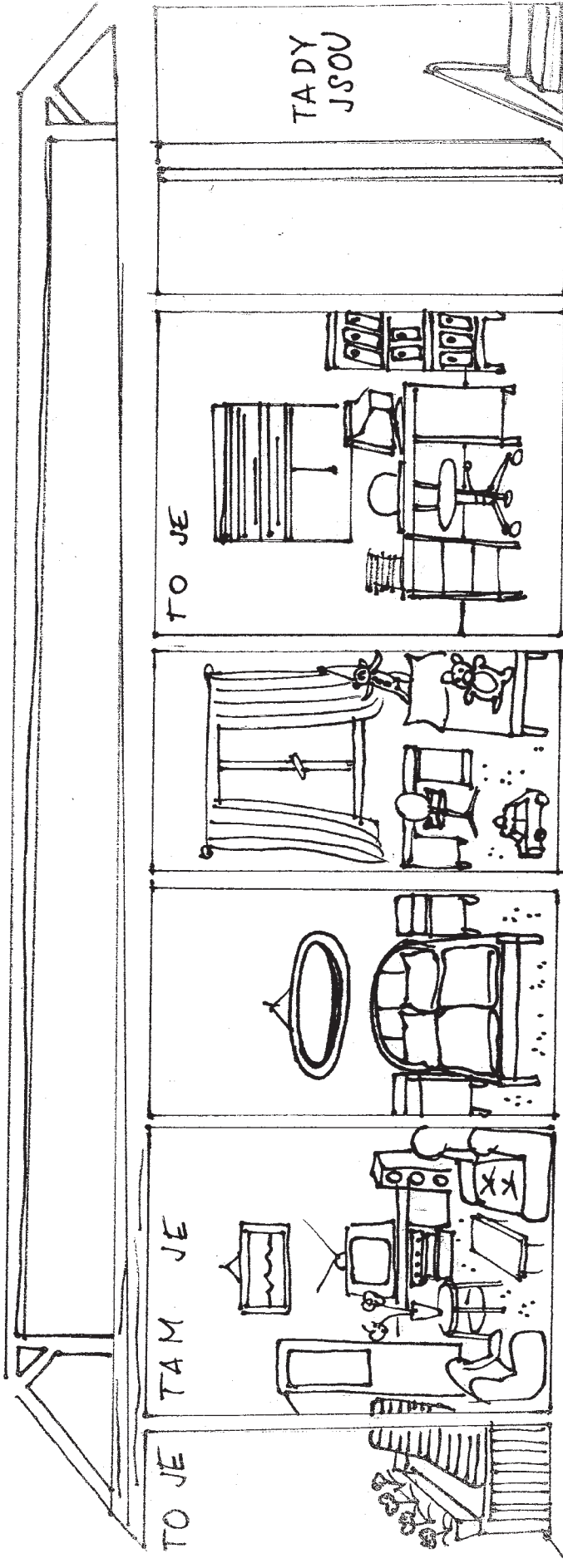

TO JE

TAM JE

TO JE

TADY JSOU

TO JE

TADY JE

TO JE

TADY JE

TADY JE TO JE

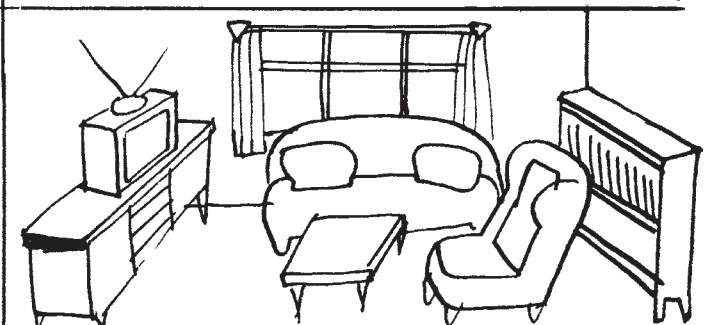
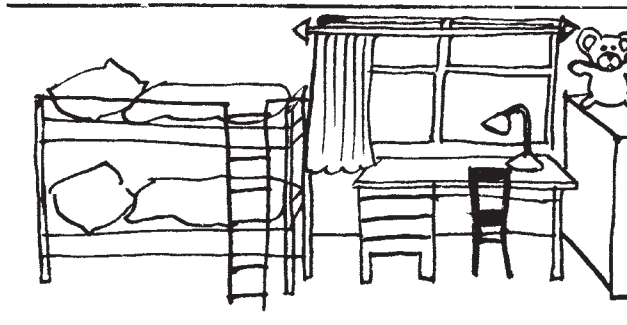
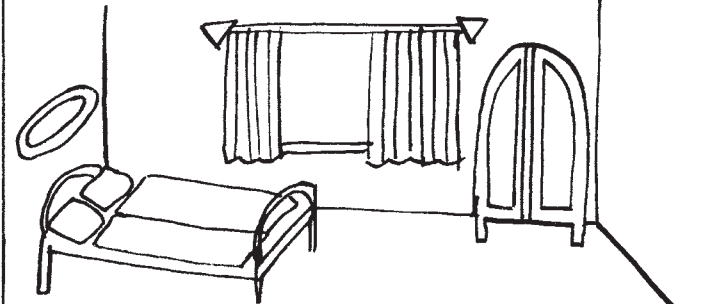
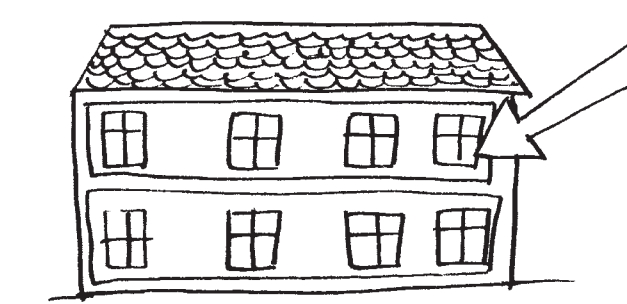
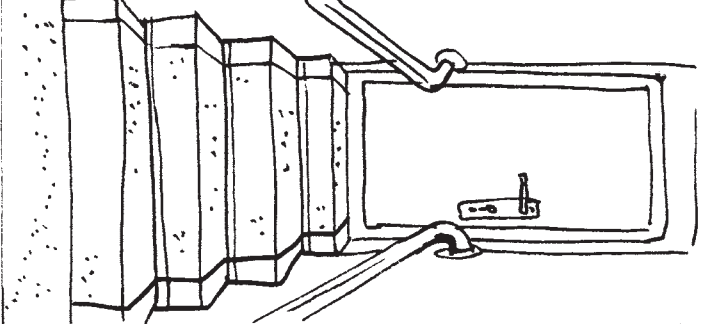
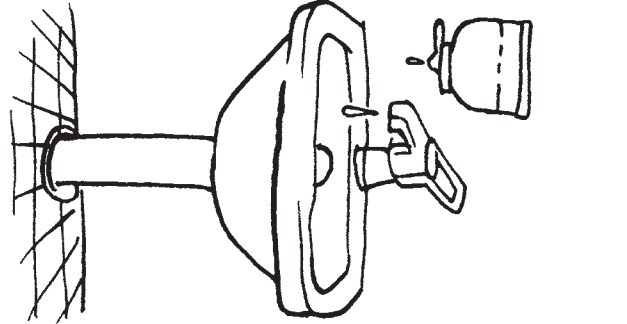
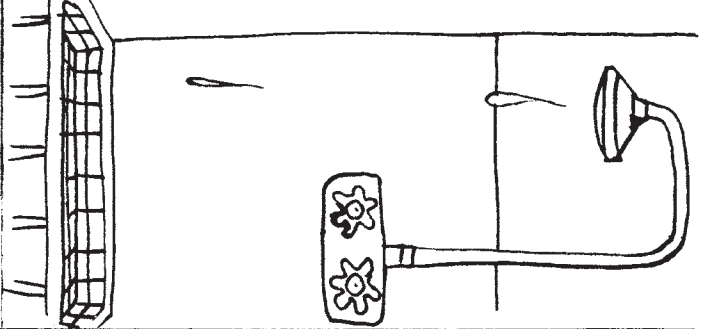
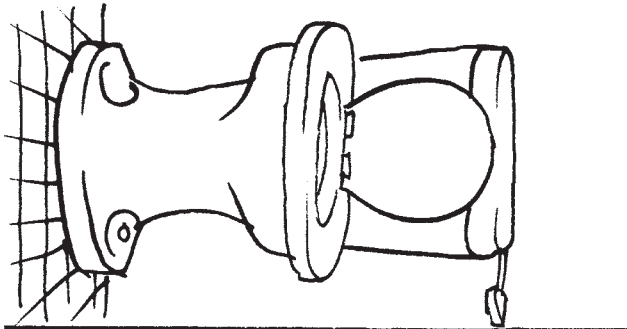
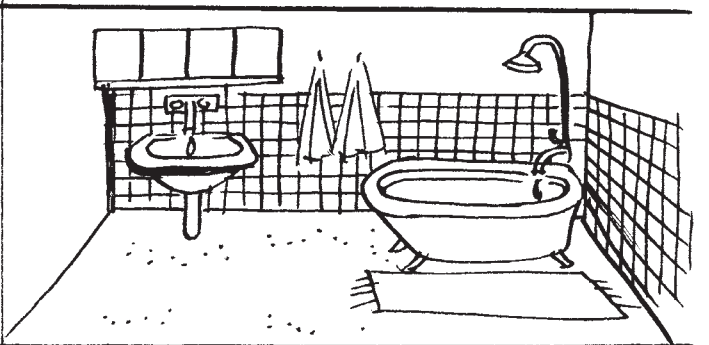
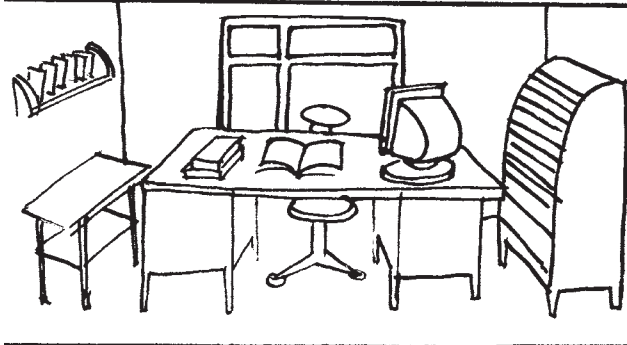
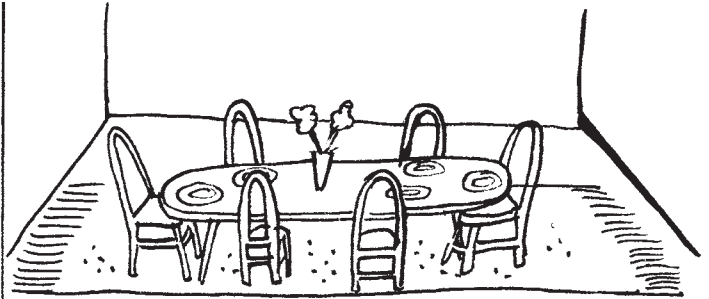
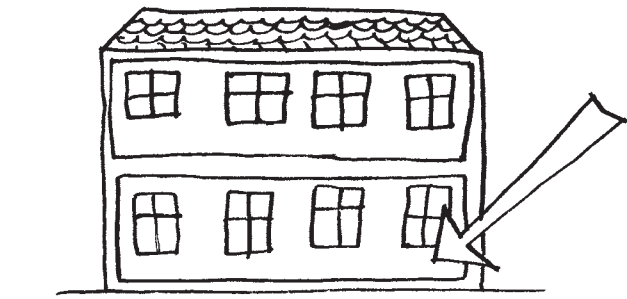



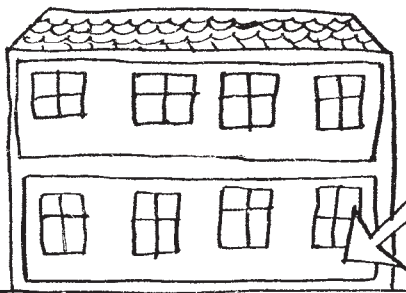

PRÍZEMÍ

JÍDELNA

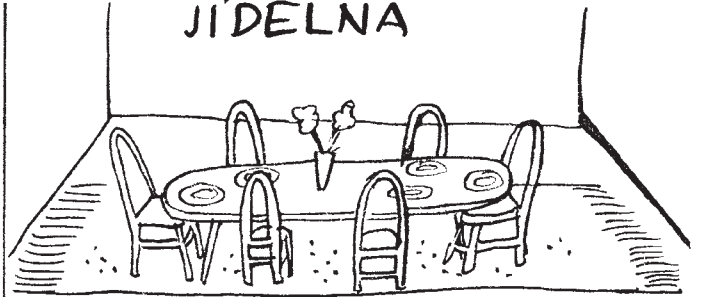

KANCELÁŘ

KOUPELNA

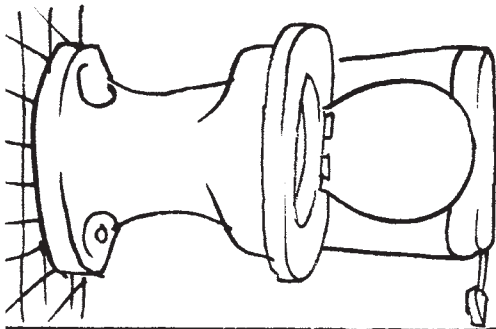
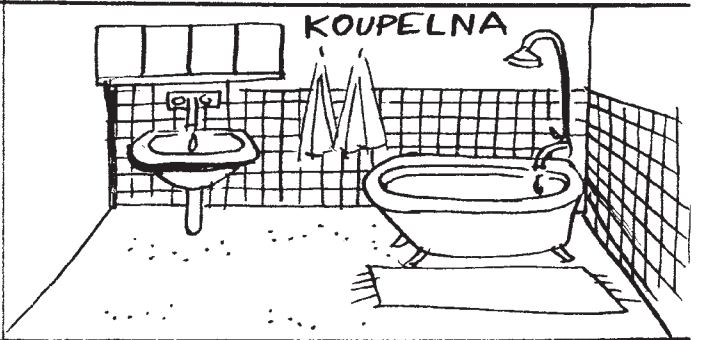

ZÁCHOD

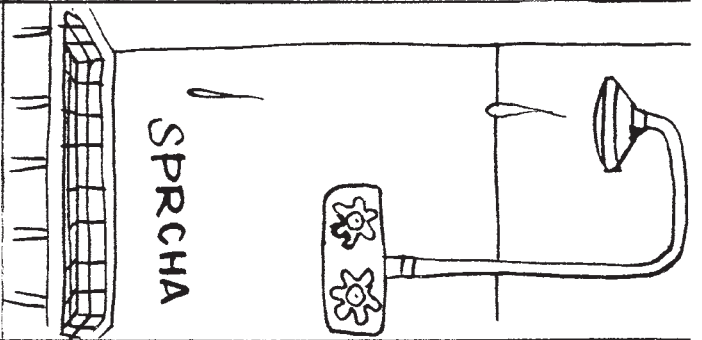

SPRCHA

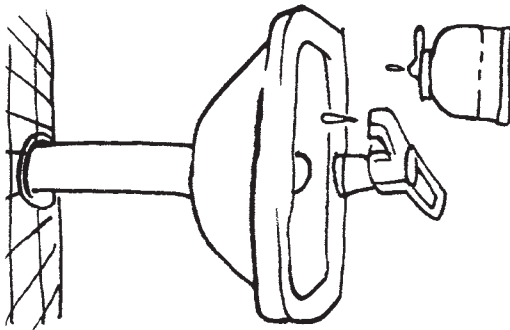

UMÝVADLO

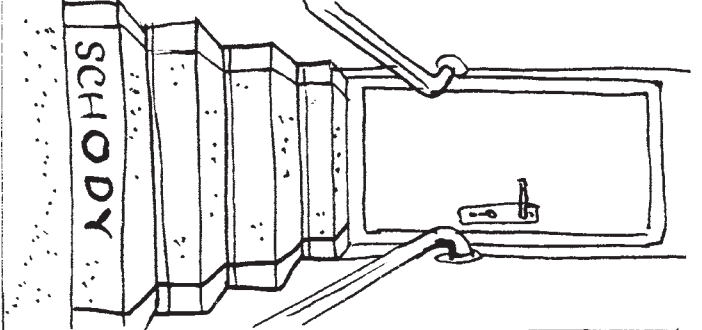

SCHODY

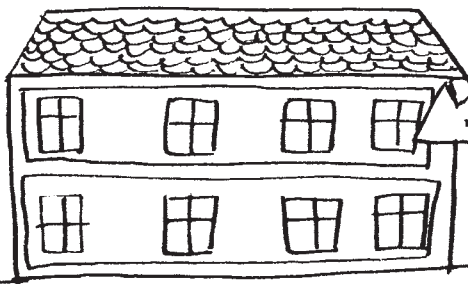

1. PATRO

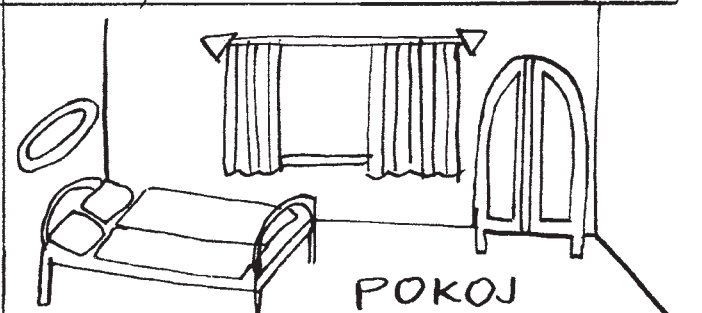

POKOJ

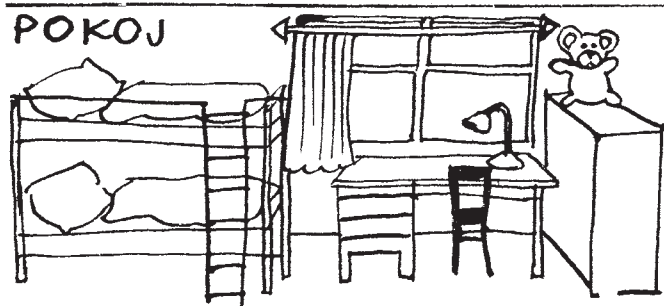

POKOJ

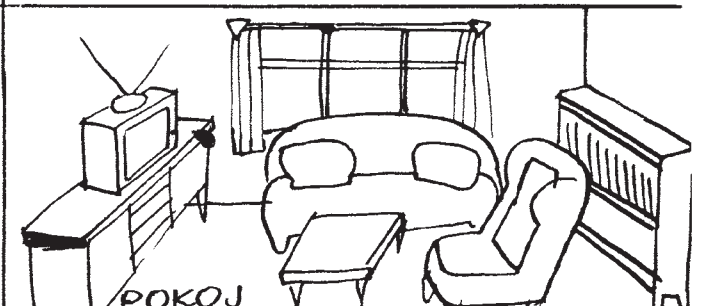

POKOJ

DVEŘE  
KŘESLO  
KVĚTINA  
LAMPA  
OBRAZ  
OKNO  
POLICE  
POSTEL  
SKŘÍŇ  
STŮL  
TELEFON  
ZRCADLO  
ŽIDLE

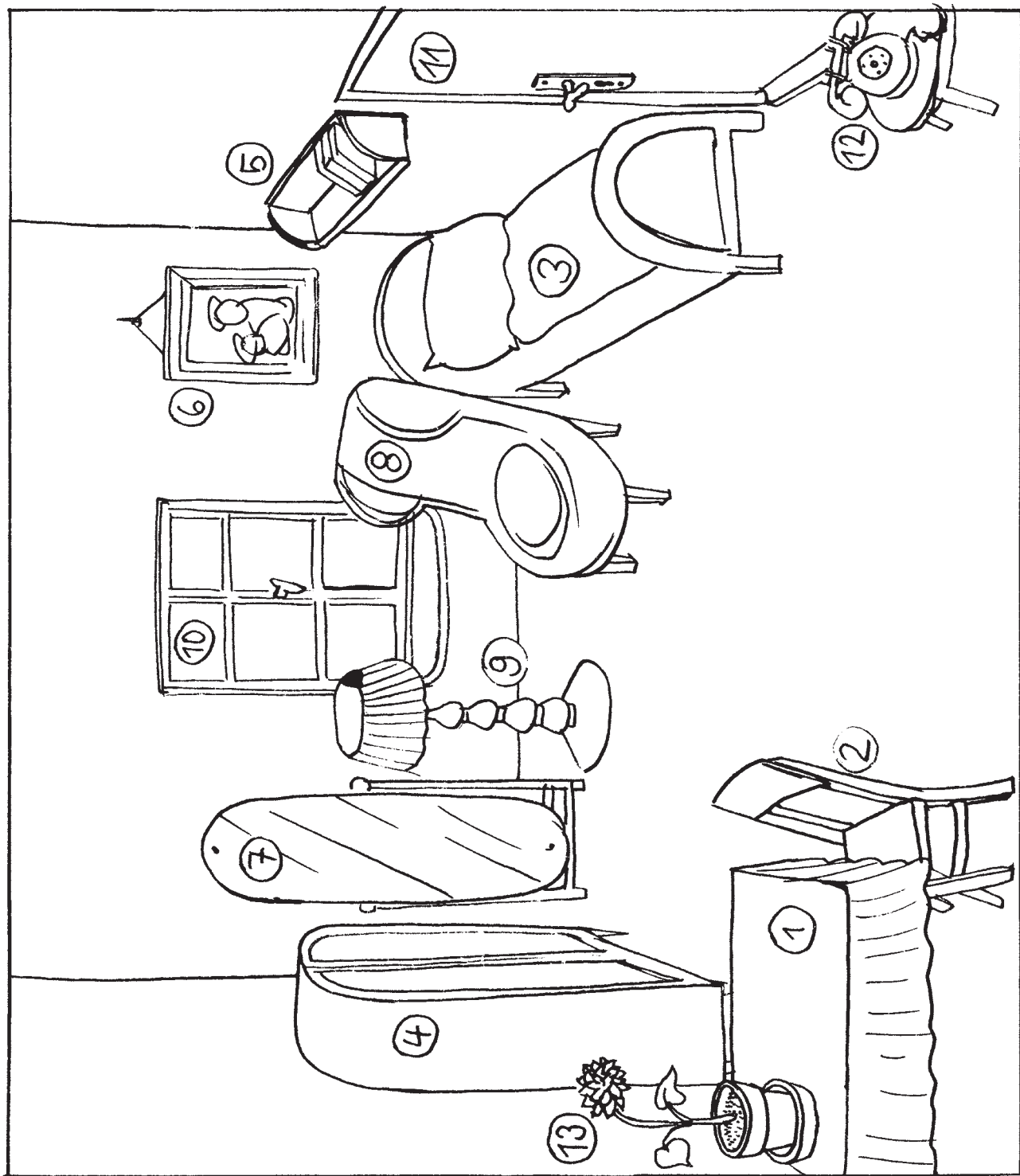

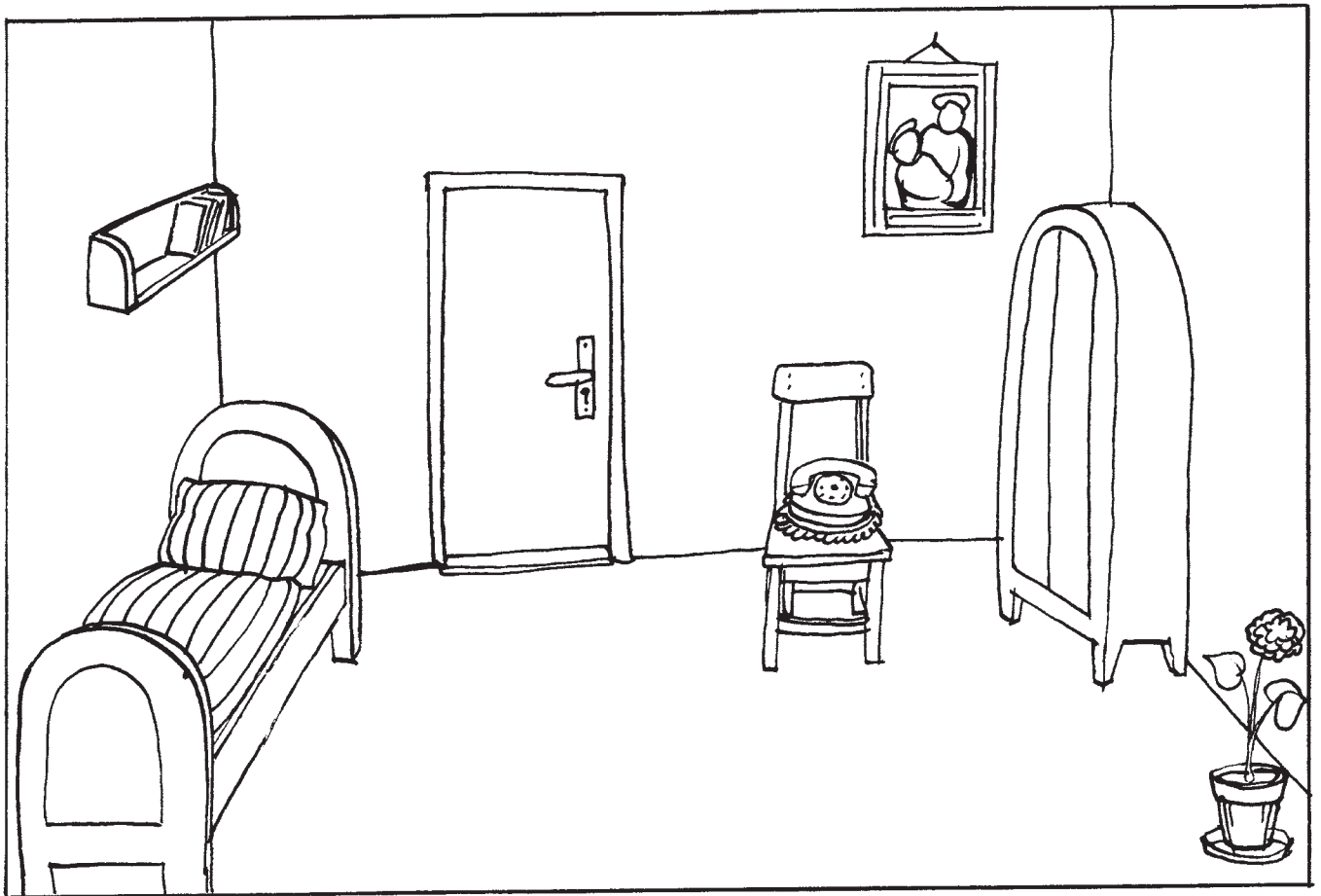
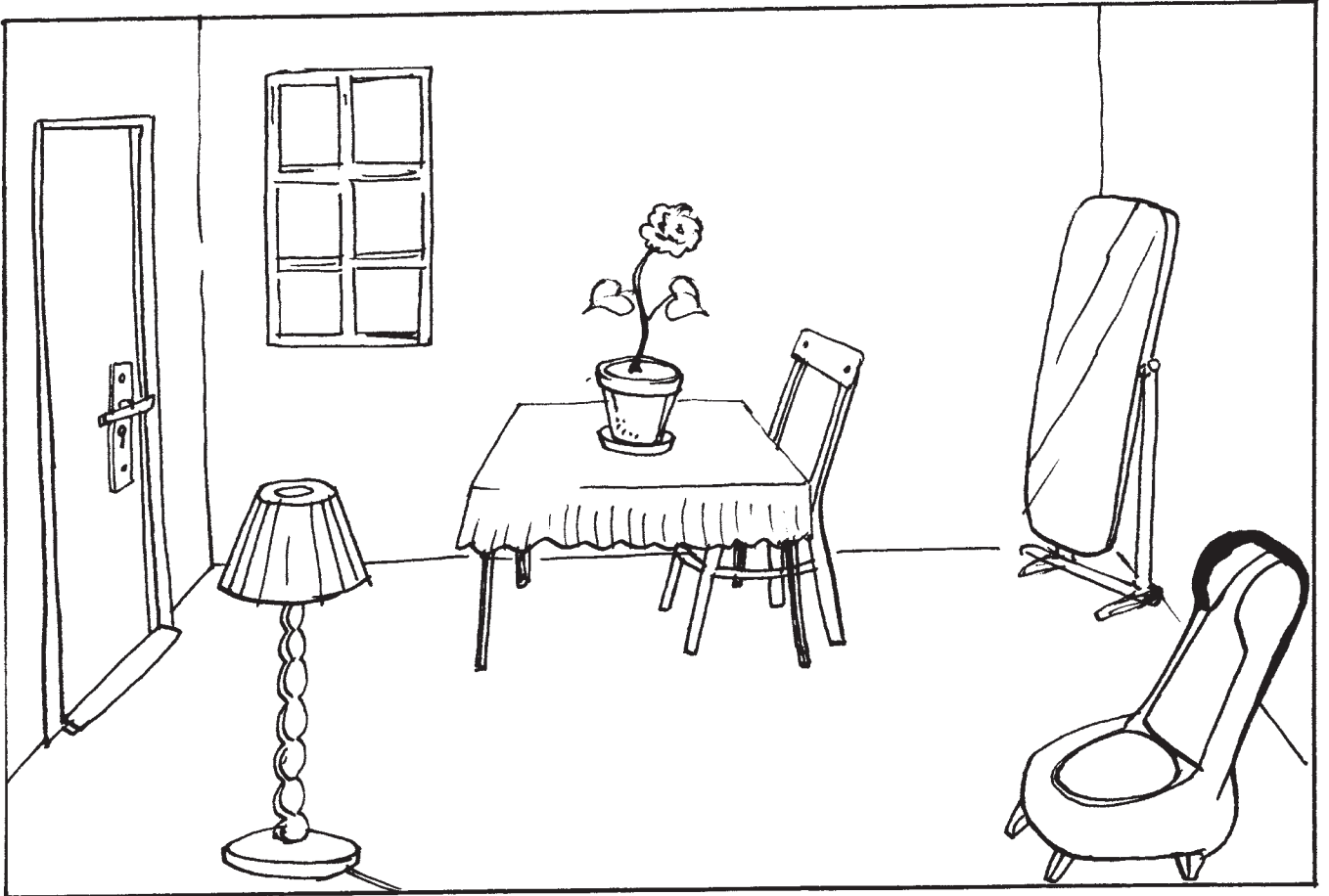

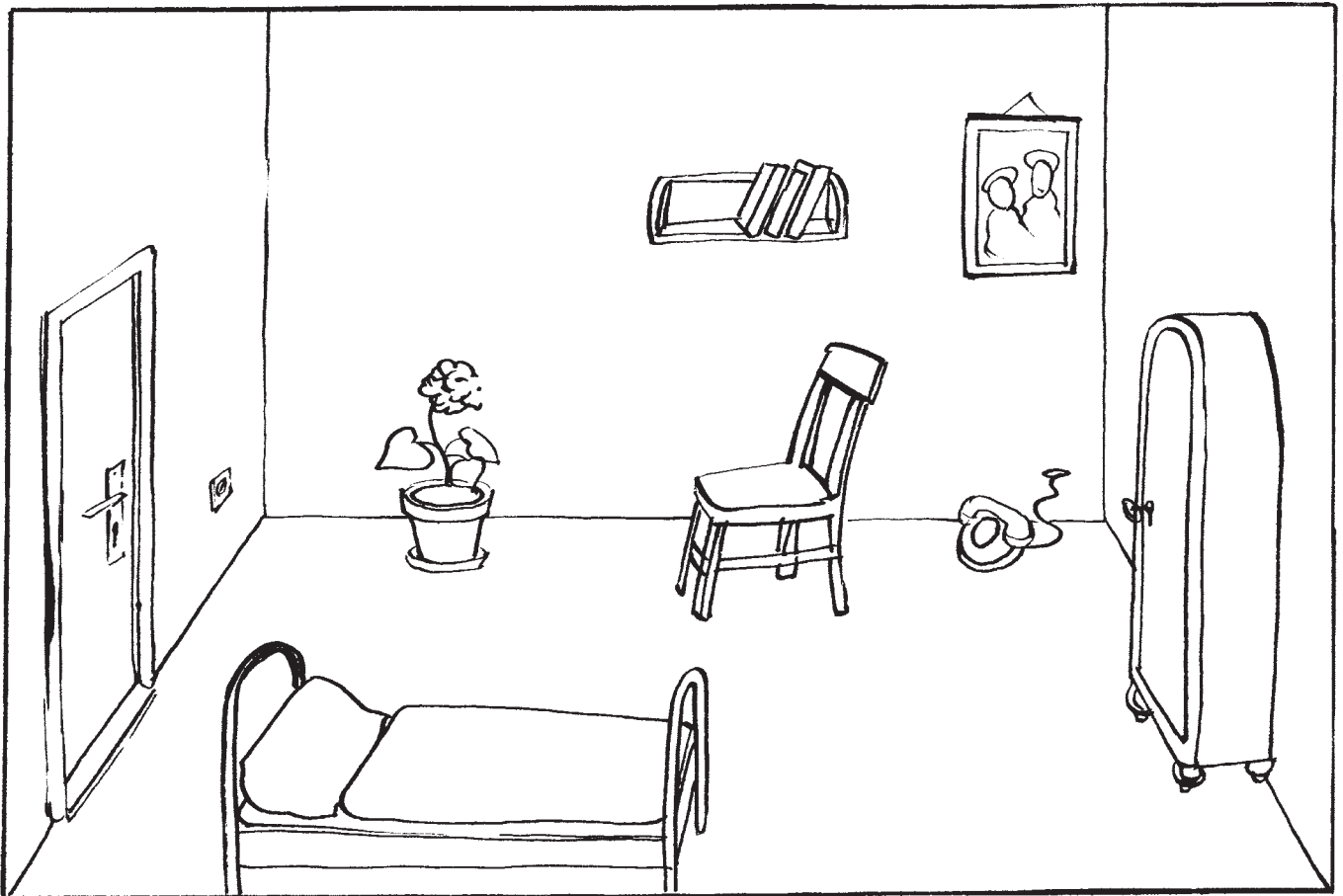
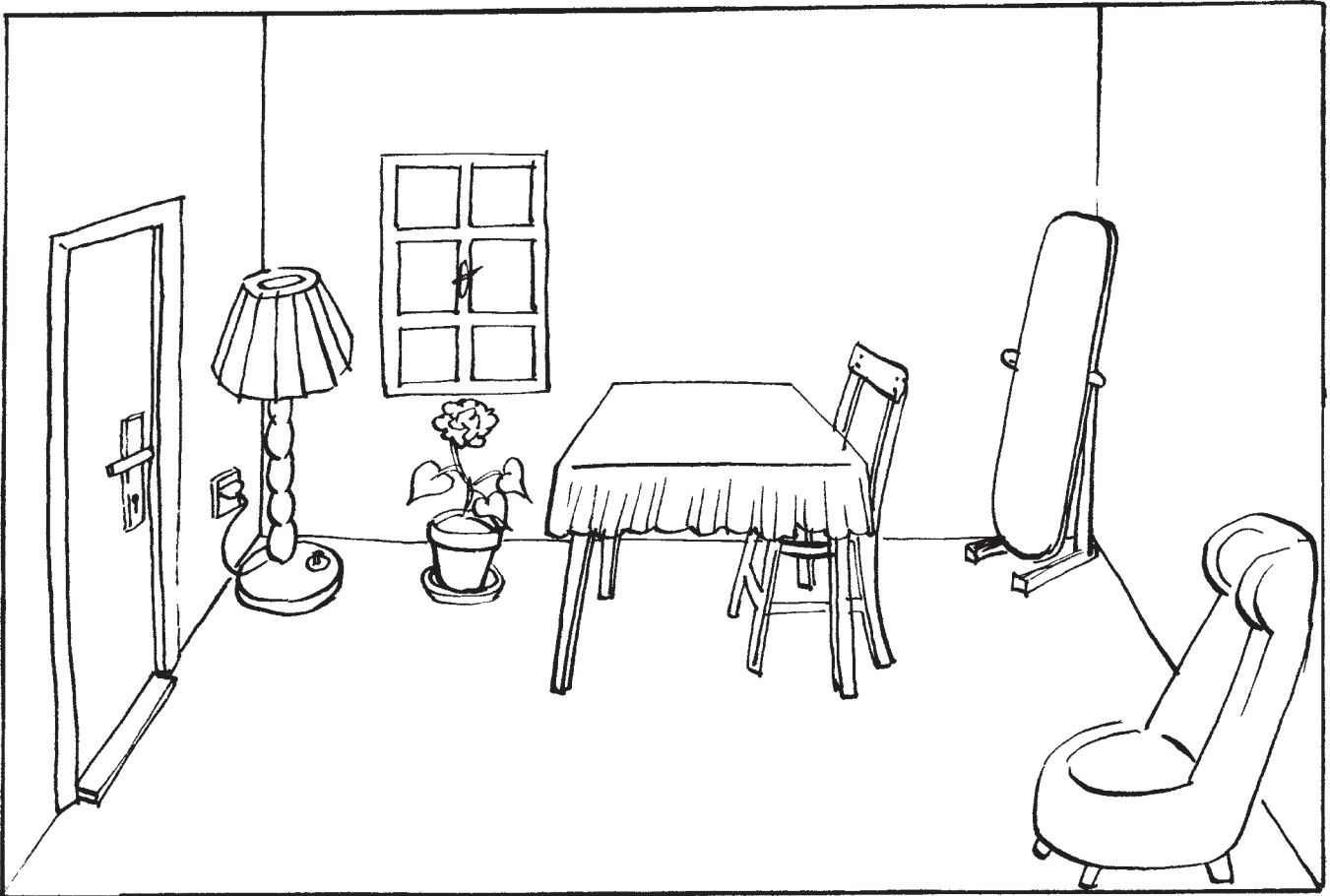



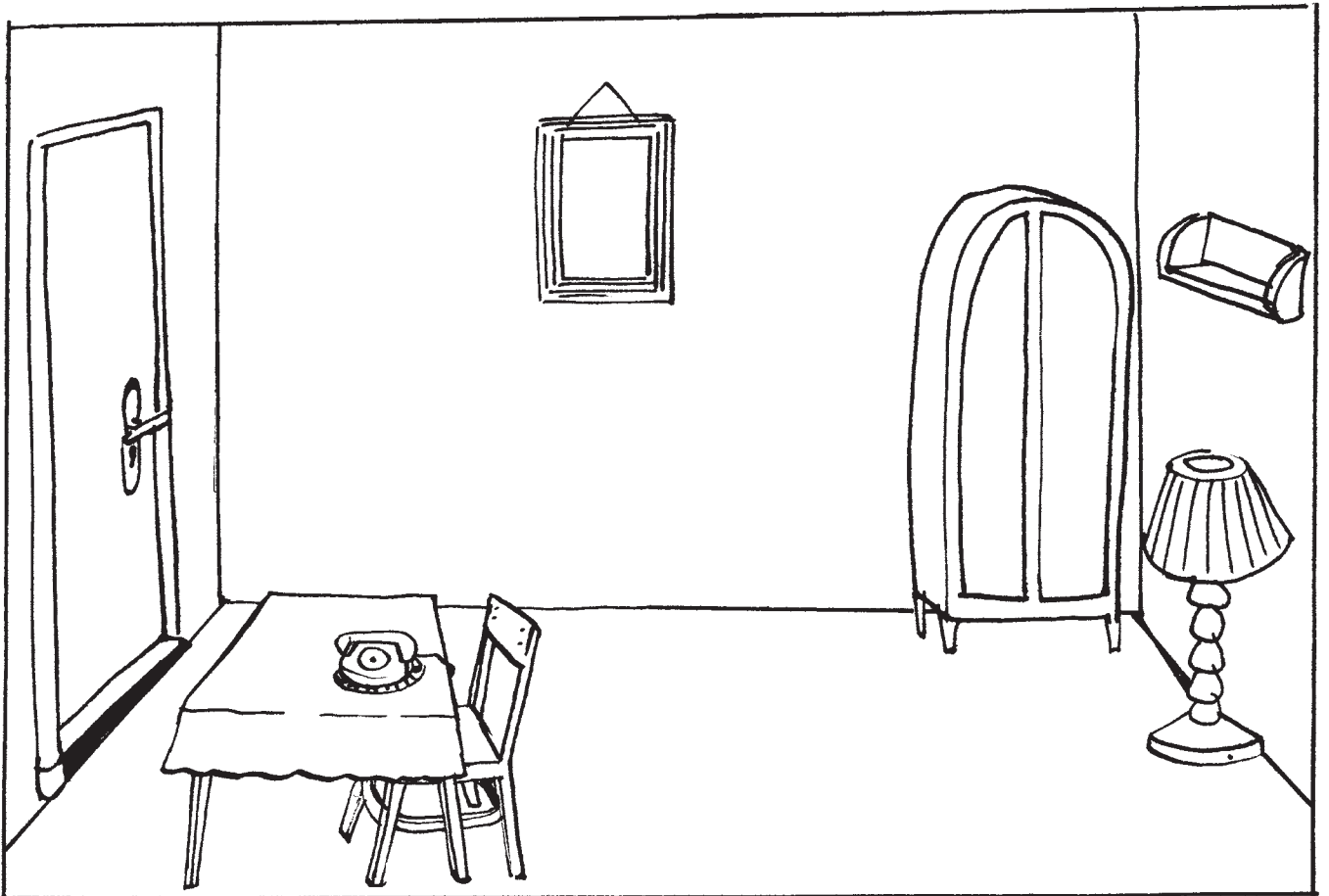
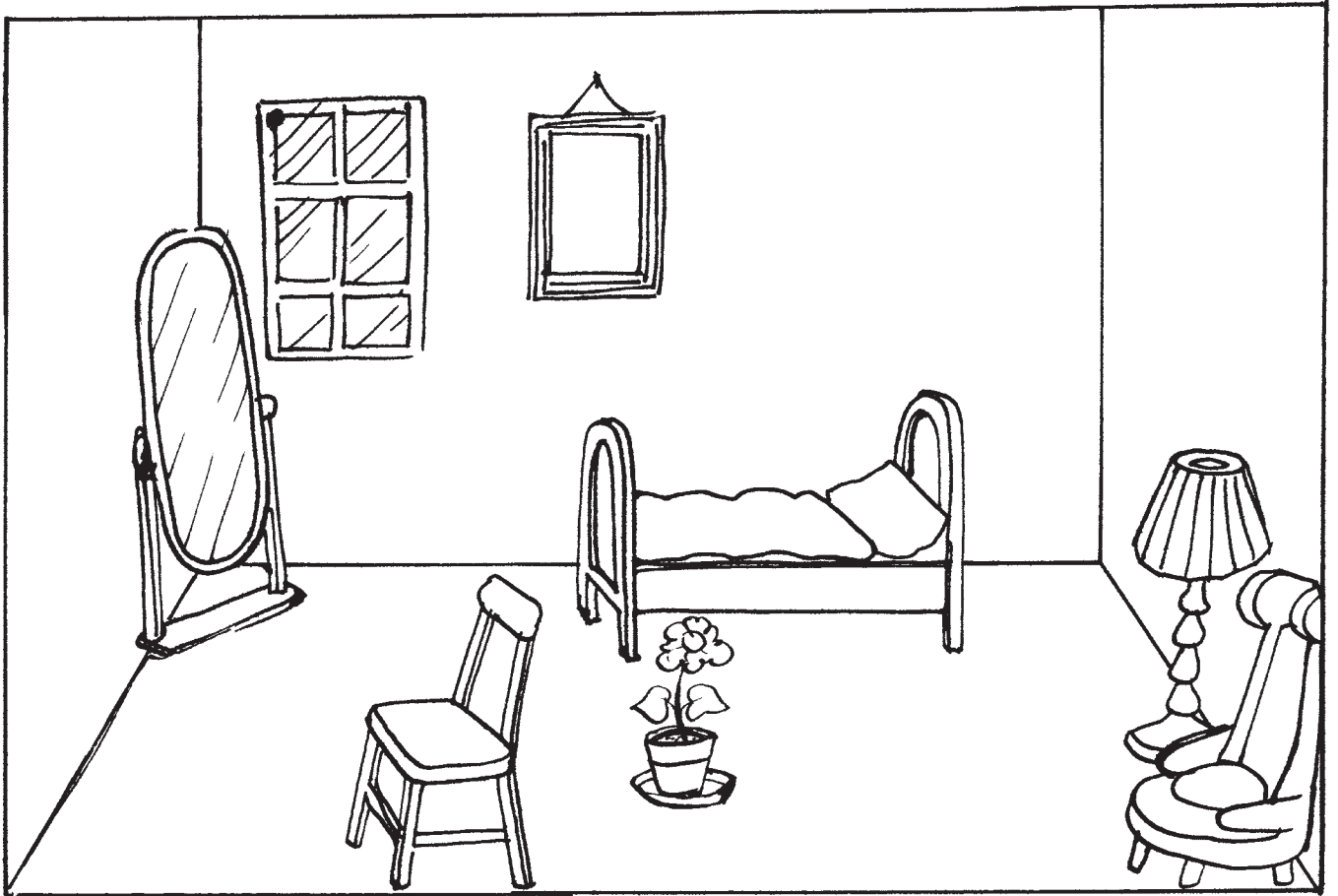

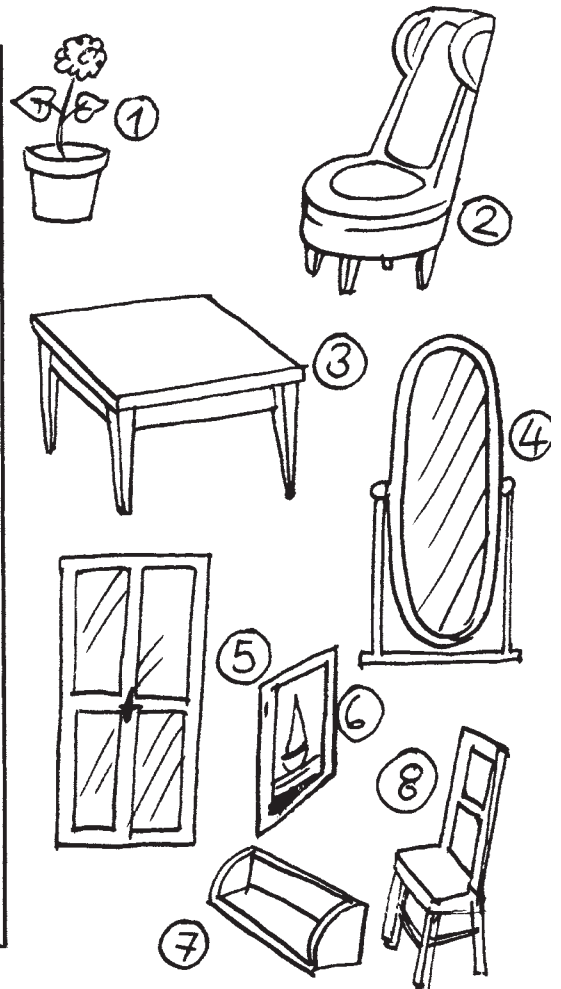
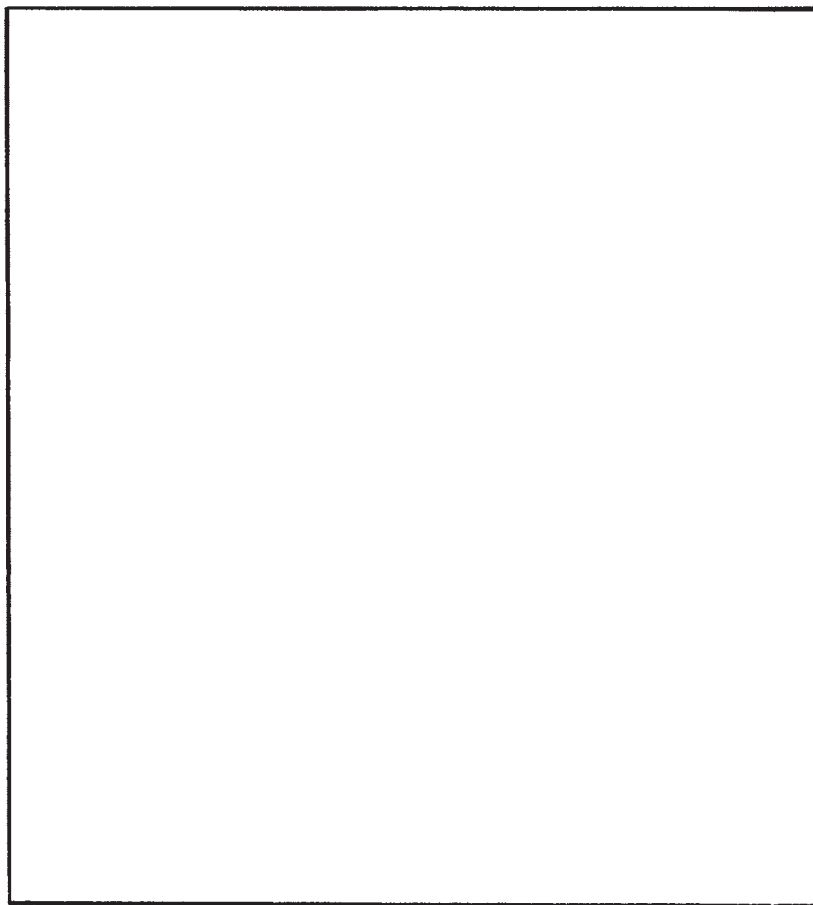
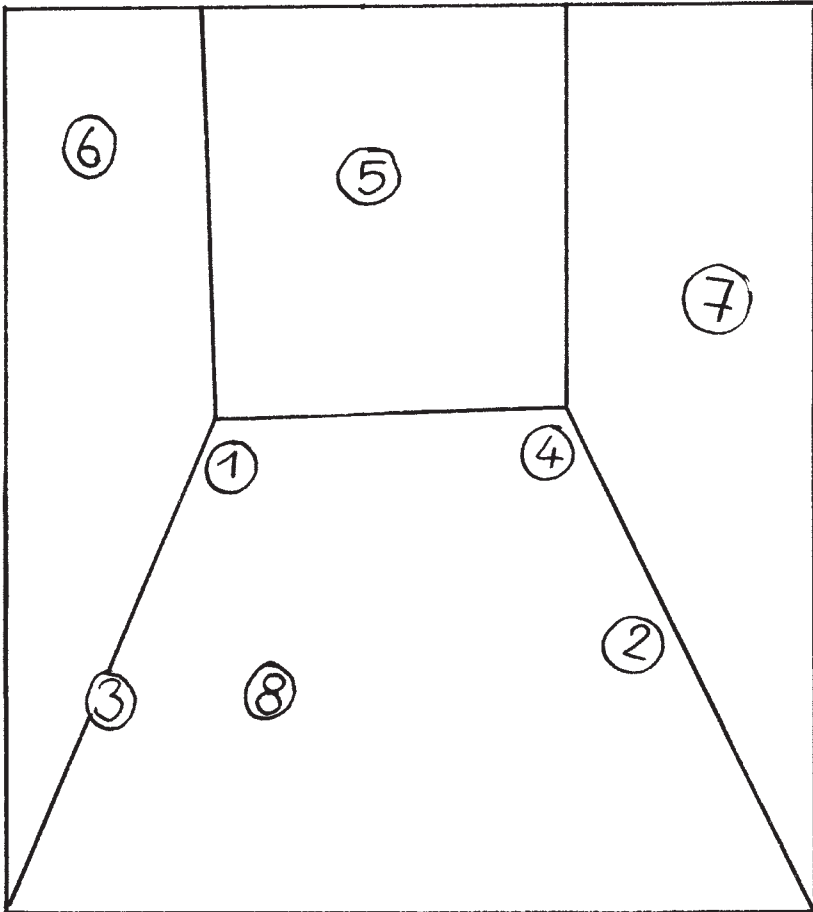

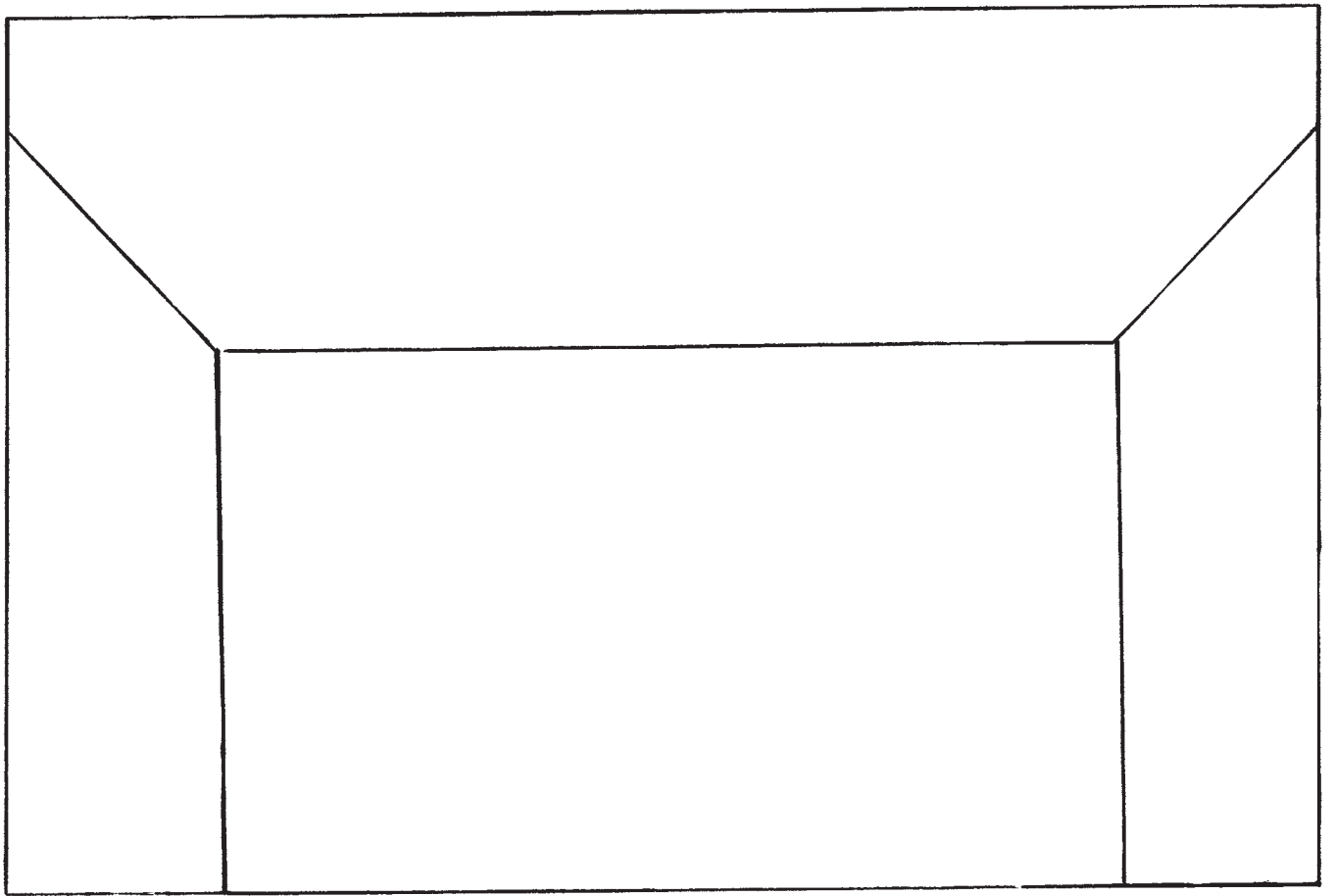
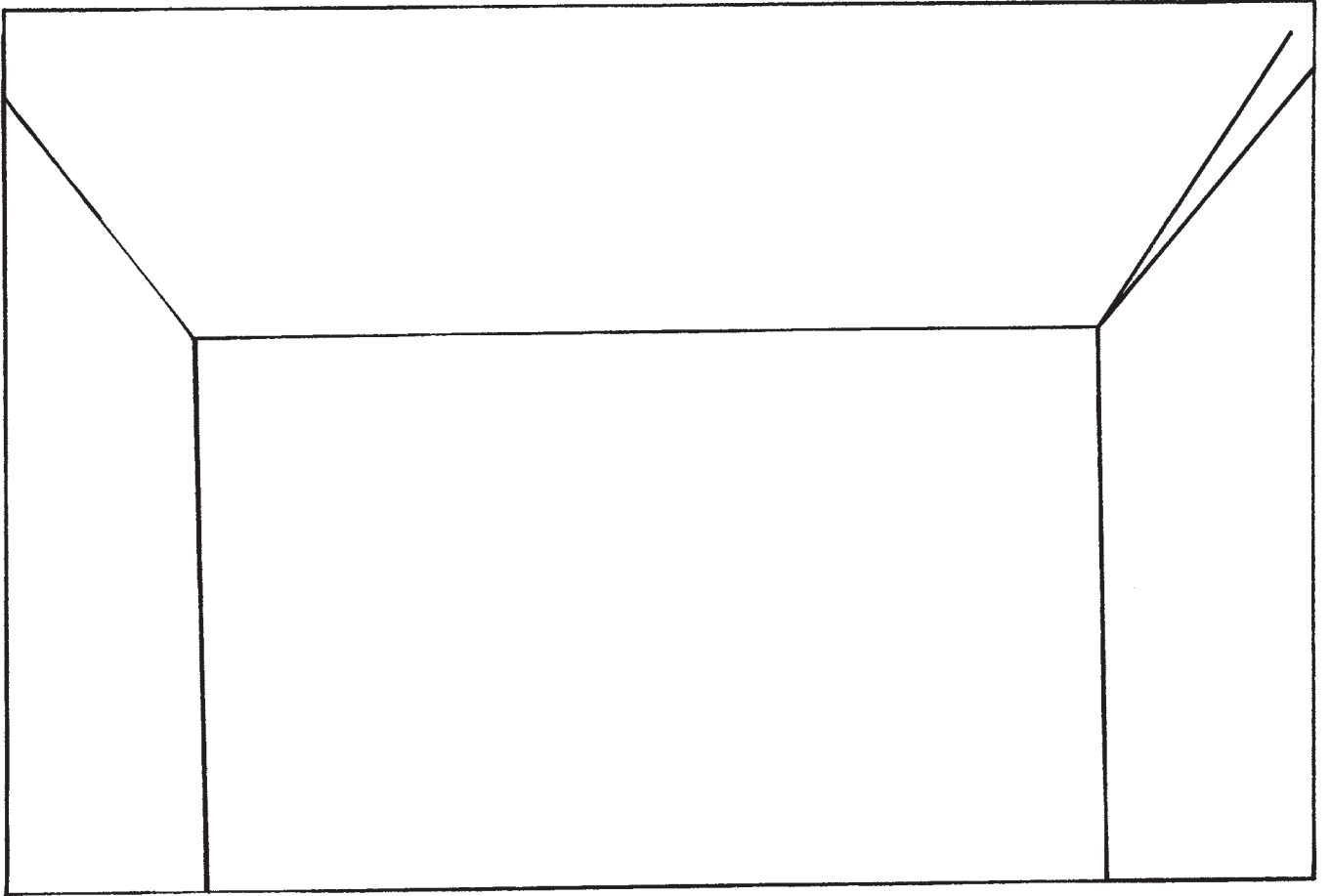

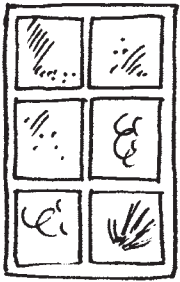

ŠPINAVÉ  
OKNO

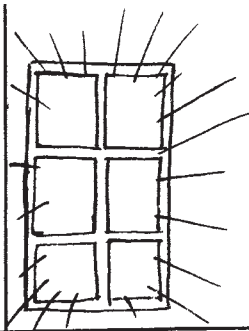

ČISTÉ  
OKNO

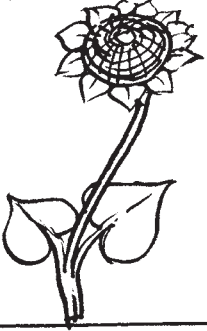

VELKÁ  
KVĚTINA



MALÁ  
KVĚTINA

SVĚTLÝ POKOJ

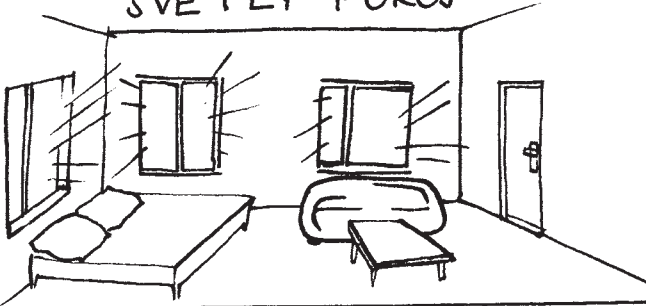

TMAVÝ POKOJ

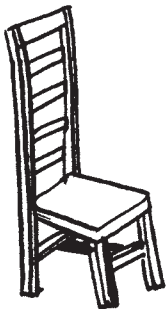
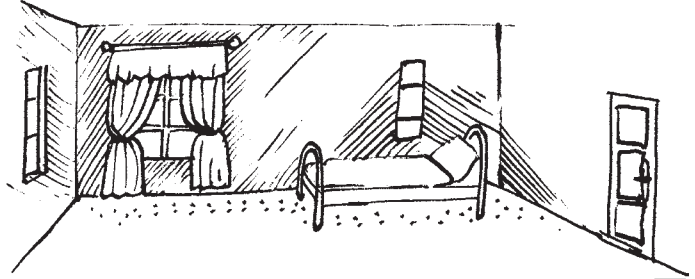

NOVÁ  
ŽIDLE

STARÁ  
ŽIDLE

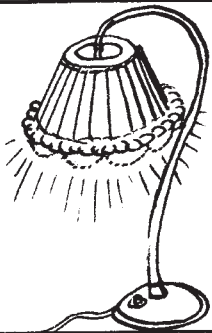
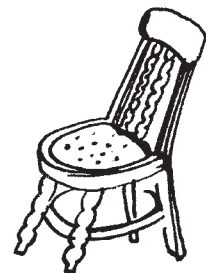

DRAHÁ  
LAMPA

LEVNÁ  
LAMPA

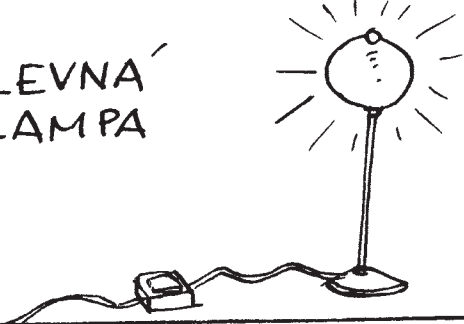

HEZKÝ  
OBRAZ

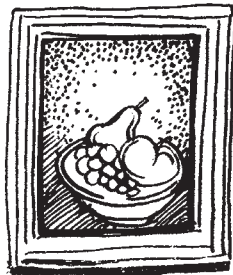

OŠKLIVÝ  
OBRAZ



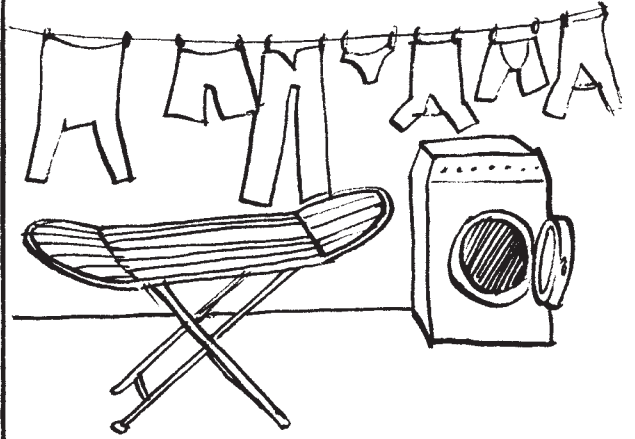
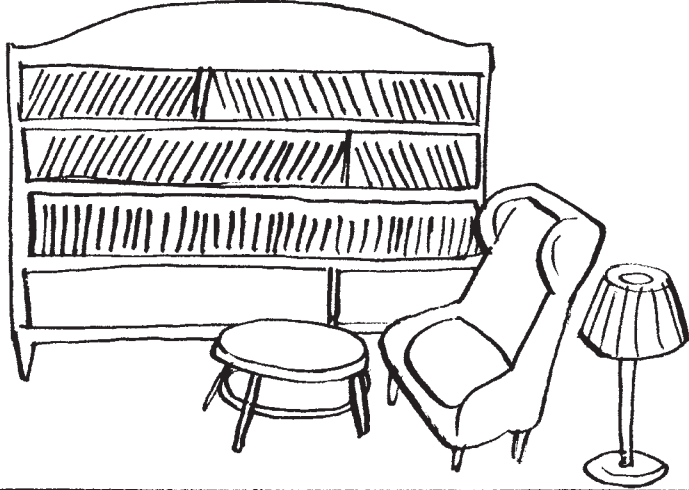
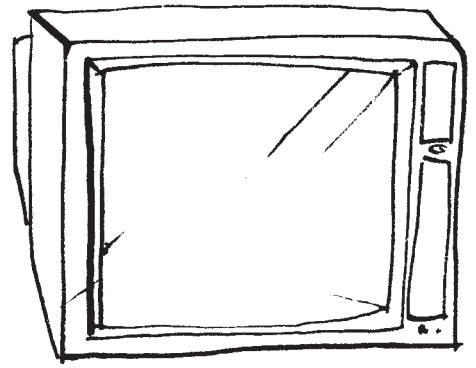
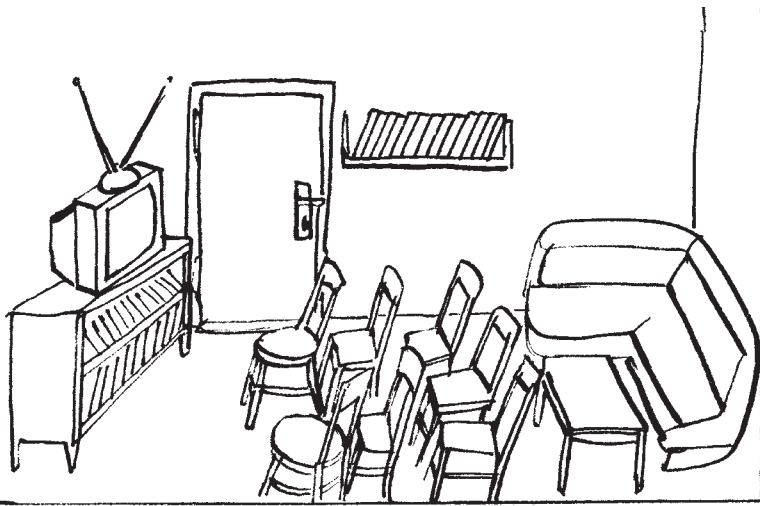

KLUBOVNA

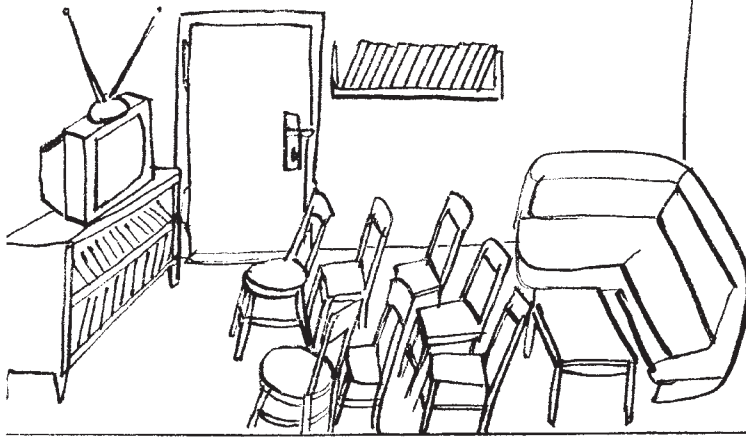

TELEVIZIE

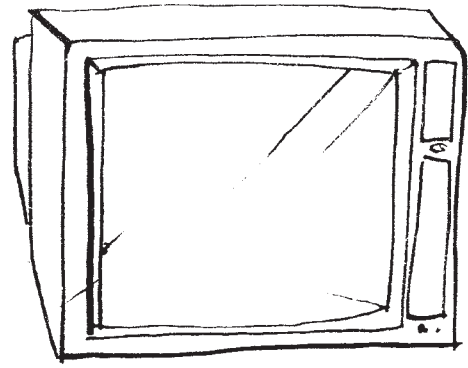

KNIHOVNA

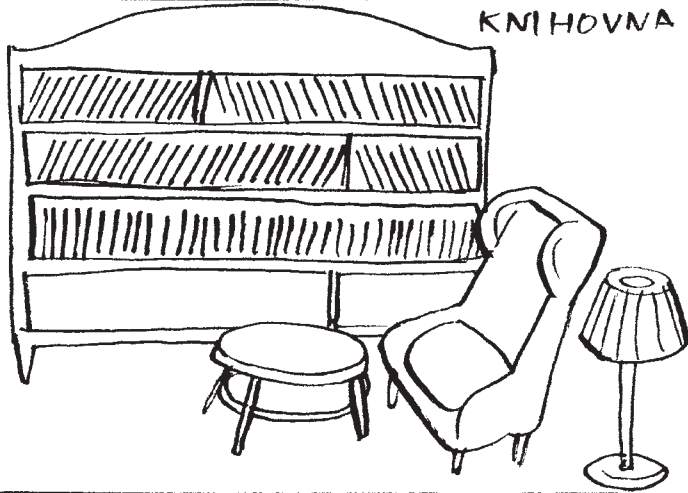

PRA'DELNA

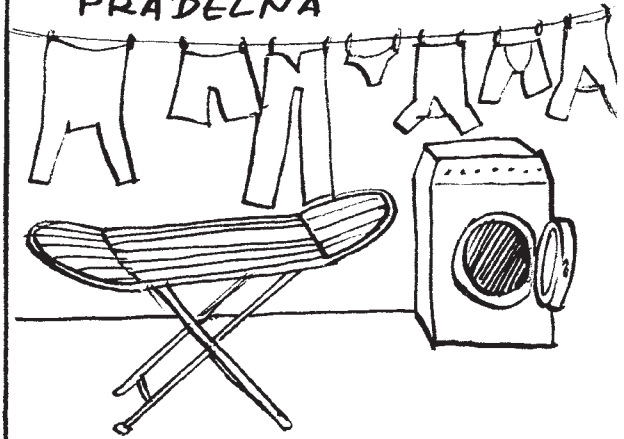

DŮM

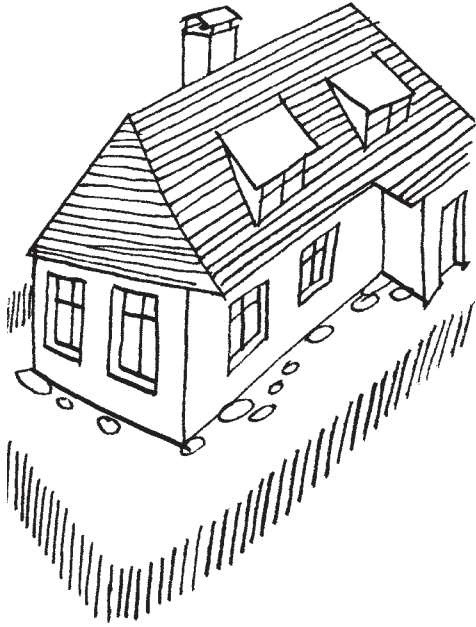

BYT



POBYTOVÉ STŘEDISKO  
PRO ŽADATELE O AZYL  
(UPRCHLICKÝ TÁBOR)



### Můj byt

Můj byt je v prvním patře. Bydlím tam já a moje manželka. Byt není malý, je to 3+1. Jsou tam tři pokoje: obývací, ložnice a kancelář. V kuchyni je taky jídelna. Máme koupelnu, tam je sprcha, umyvadlo a vana. Máme taky balkon. Náš dům není velký, má jen tři patra, proto tam není výtah.

### Můj byt

Můj byt je v prvním patře. Bydlím tam já a moje manželka. Byt není malý, je to 3+1. Jsou tam tři pokoje: obývací, ložnice a kancelář. V kuchyni je taky jídelna. Máme koupelnu, tam je sprcha, umyvadlo a vana. Máme taky balkon. Náš dům není velký, má jen tři patra, proto tam není výtah.

### Můj byt

Můj byt je v prvním patře. Bydlím tam já a moje manželka. Byt není malý, je to 3+1. Jsou tam tři pokoje: obývací, ložnice a kancelář. V kuchyni je taky jídelna. Máme koupelnu, tam je sprcha, umyvadlo a vana. Máme taky balkon. Náš dům není velký, má jen tři patra, proto tam není výtah.

### Můj byt

Můj byt je v prvním patře. Bydlím tam já a moje manželka. Byt není malý, je to 3+1. Jsou tam tři pokoje: obývací, ložnice a kancelář. V kuchyni je taky jídelna. Máme koupelnu, tam je sprcha, umyvadlo a vana. Máme taky balkon. Náš dům není velký, má jen tři patra, proto tam není výtah.

### Můj byt

Můj byt je v prvním patře. Bydlím tam já a moje manželka. Byt není malý, je to 3+1. Jsou tam tři pokoje: obývací, ložnice a kancelář. V kuchyni je taky jídelna. Máme koupelnu, tam je sprcha, umyvadlo a vana. Máme taky balkon. Náš dům není velký, má jen tři patra, proto tam není výtah.



**Časování sloves pracovat a jmenovat se:**

(já) pracuju	
(ty) pracuješ	(vy) pracujete
(on, ona) pracuje	

(já) jmenuju se	
(ty) jmenuješ se	(vy) jmenujete se
(on, ona) jmenuje se	

**Časování sloves pracovat a jmenovat se:**

(já) pracuju	
(ty) pracuješ	(vy) pracujete
(on, ona) pracuje	

(já) jmenuju se	
(ty) jmenuješ se	(vy) jmenujete se
(on, ona) jmenuje se	

JMÉNO:  
PŘÍJMENÍ:  
DATUM NAROZENÍ:  
MÍSTO NAROZENÍ:  
POHLAVÍ:  
ZEMĚ PŮVODU:  
STÁTNÍ PŘÍSLUŠNOST:  
ČÍSLO PASU:  
POVOLÁNÍ:  
BYDLIŠTĚ V ČR:

JAK DLOUHO JSTE V ČR:  
STAV:  
BYDLIŠTĚ MANŽELA/MANŽELKY:

POČET DĚTÍ:  
DŮVOD POBYTU V ČR:

JMÉNO:  
PŘÍJMENÍ:  
DATUM NAROZENÍ:  
MÍSTO NAROZENÍ:  
POHLAVÍ:  
ZEMĚ PŮVODU:  
STÁTNÍ PŘÍSLUŠNOST:  
ČÍSLO PASU:  
POVOLÁNÍ:  
BYDLIŠTĚ V ČR:

JAK DLOUHO JSTE V ČR:  
STAV:  
BYDLIŠTĚ MANŽELA/MANŽELKY:

POČET DĚTÍ:  
DŮVOD POBYTU V ČR:

50 1 2 5 10 20

50 Kč 100 STO KORUN ČESKÝCH

DVĚ STĚ KORUN ČESKÝCH 200

PĚT SET KORUN ČESKÝCH 500

TIŠÍC KORUN ČESKÝCH 1000

DVA TIŠÍCE KORUN ČESKÝCH 2000

PĚT TIŠÍC KORUN ČESKÝCH 5000

**PAS**

JMÉNO:

PŘÍJMENÍ:

ČÍSLO PASU:

STÁTNÍ PŘÍSLUŠNOST:

DATUM NAROZENÍ:

MÍSTO NAROZENÍ:

POHLAVÍ:

**PAS**

JMÉNO:

PŘÍJMENÍ:

ČÍSLO PASU:

STÁTNÍ PŘÍSLUŠNOST:

DATUM NAROZENÍ:

MÍSTO NAROZENÍ:

POHLAVÍ:

**PRACOVNÍ ÚŘAD**

JMÉNO:

DATUM NAROZENÍ:

POHLAVÍ:

BYDLIŠTĚ:

POVOLÁNÍ:

**PRACOVNÍ ÚŘAD**

JMÉNO:

DATUM NAROZENÍ:

POHLAVÍ:

BYDLIŠTĚ:

POVOLÁNÍ:

**PRACOVNÍ ÚŘAD**

JMÉNO:

DATUM NAROZENÍ:

POHLAVÍ:

BYDLIŠTĚ:

POVOLÁNÍ:

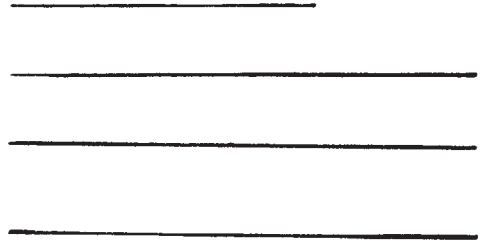
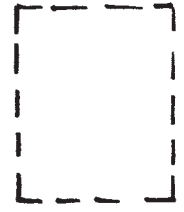

**ŽÁDOST O POVOLENÍ K POBYTU**

JMÉNO A PŘÍJMENÍ:

ZEMĚ PŮVODU:

DATUM NAROZENÍ:

POHLAVÍ:

JAK DLOUHO JSTE V ČR:

BYDLIŠTĚ V ČR:

STAV:

BYDLIŠTĚ MANŽELA/MANŽELKY:

POČET DĚTÍ:

DŮVOD POBYTU V ČR:

**ŽÁDOST O POVOLENÍ K POBYTU**

JMÉNO A PŘÍJMENÍ:

ZEMĚ PŮVODU:

DATUM NAROZENÍ:

POHLAVÍ:

JAK DLOUHO JSTE V ČR:







BYDLIŠTĚ V ČR:

STAV:

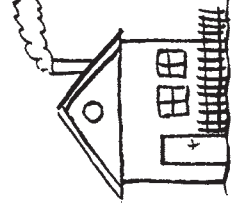
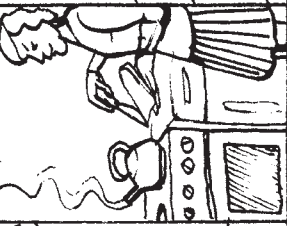
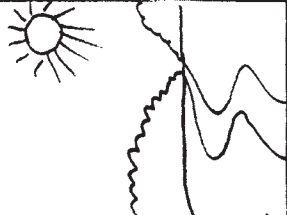
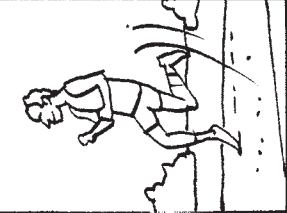
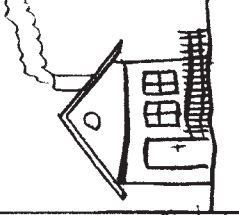
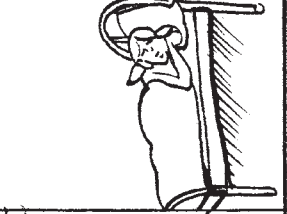
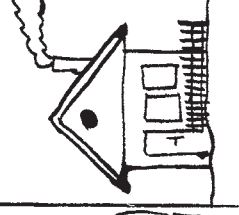
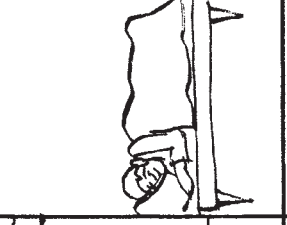
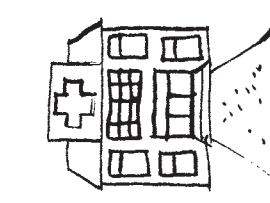
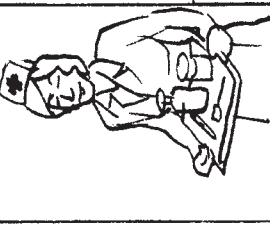
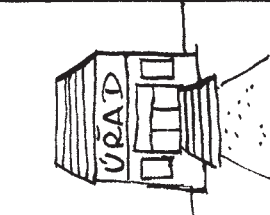
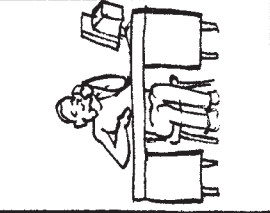
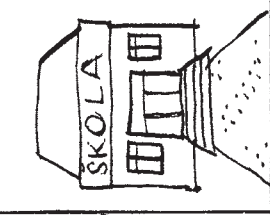
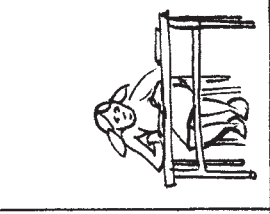
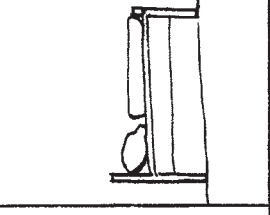
BYDLIŠTĚ MANŽELA/MANŽELKY:

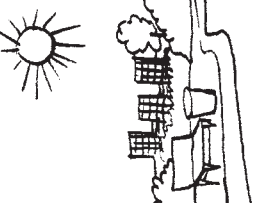
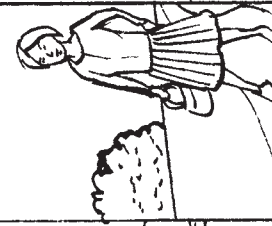
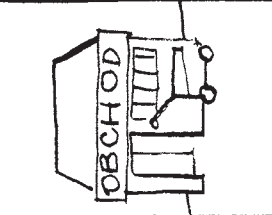
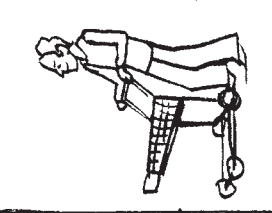
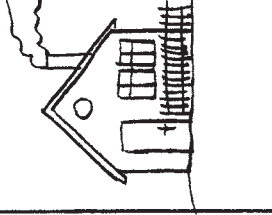
POČET DĚTÍ:

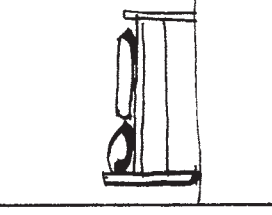
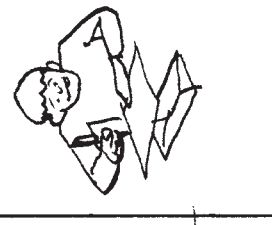
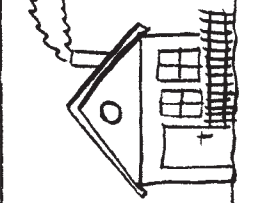
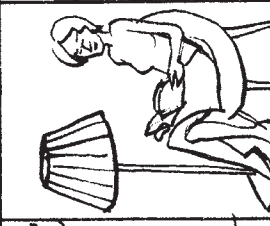
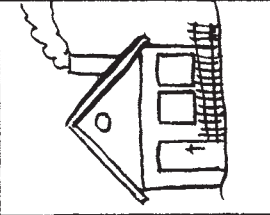
DŮVOD POBYTU V ČR:

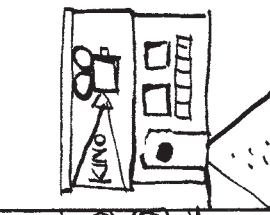
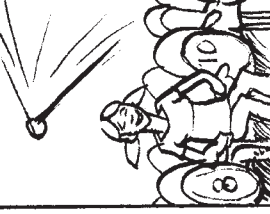
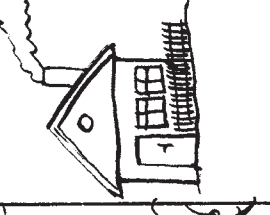
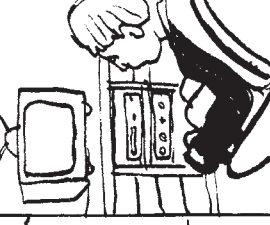
	MATKA		OTEC		DCERA		SYN	
	KDE JE?	CO DĚLA?	KDE JE?	CO DĚLA?	KDE JE?	CO DĚLA?	KDE JE?	CO DĚLA?
RAŇNO								
DOPOLEDNE								
ODPOLEDNE								
VEČER								



	RAŇO	DOPoledNE	ODPOLEDNE	VECER
	KDE JE?			
	CO DEĽA?			
	KDE JE?			
	CO DEĽA?			
	KDE JE?			
	CO DEĽA?			
	KDE JE?			
	CO DEĽA?			

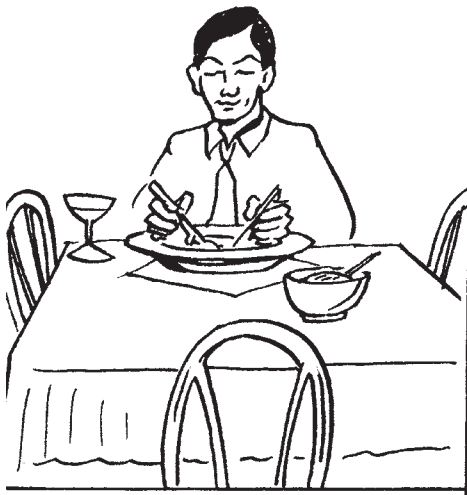

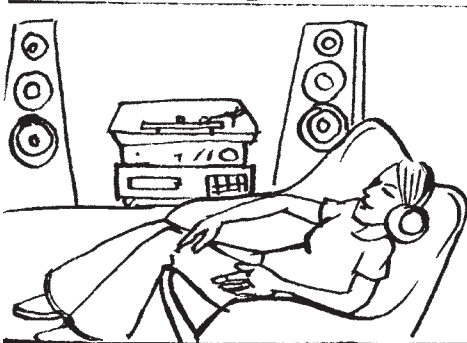
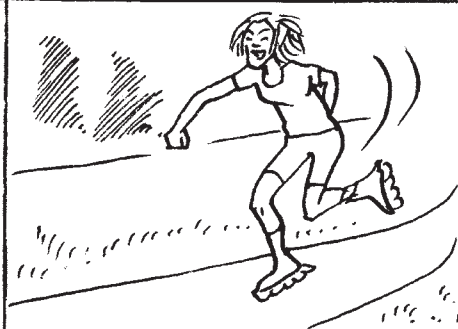
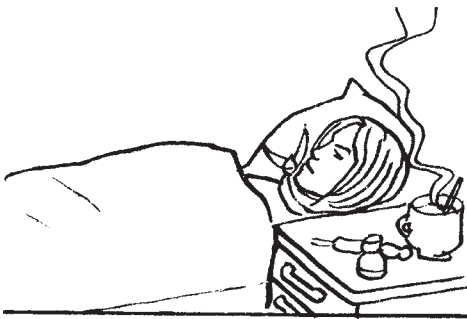

	KDE JSEM ?	CO DĚLÁM?
R		
D		
O		
V		

Jan Soukup  
Pražská 508  
530 02 Pardubice

fa STAVO s.r.o.  
Ing. Strnadel  
F. Halase 35  
120 00 Praha 2

Pardubice 1.8.2003

### Odpověď na inzerát

Vážený pane inženýre,

reaguji na Váš inzerát uveřejněný v inzertním časopise Profit č. 57 ze dne 18.7.2003.

Jak uvidíte z příložené životopisu, jsem absolventem Středního odborného učiliště stavebního v Pardubicích a mám tříletou praxi v oboru. Moje poslední pracovní praxe byla ve stavební firmě, kde jsem se podílel na výstavbě rodinných domků pro obyvatele Pardubic.

Vlastním osobní automobil a řidičské oprávnění skupiny „B“.

Zdá se, že moje kvalifikace i dosavadní pracovní zkušenosti odpovídají Vaším požadavkům. Nastoupit mohu ihned podle Vaší potřeby.

Uvítám Vaše pozvání k přijímacímu pohovoru, při němž bych se Vám představil osobně.

S přátelským pozdravem

.....  
podpis (jen vlastnoruční)

#### Přílohy

- Životopis
- fotokopie řidičského oprávnění skupiny „B“

### Příklady formulace inzerátu

#### Se základním vzděláním

- Nekvalifikovaný 25letý dělník z Kolína, bez zdravotního omezení, hledá jakoukoliv práci s možností výdělku max. Kč 8 000,- měsíčně. Zn.: příjmení, adresa, číslo telefonu

#### Se středoškolským vzděláním

- Absolventka střední ekonomické školy s tříletou praxí jako odborný referent ekonom, se znalostí podvojného účetnictví, věk 34 let hledá zaměstnání v oboru v Brně nebo okolí na plný pracovní úvazek. Zn.: příjmení, adresa, číslo telefonu

#### S vysokoškolským vzděláním

- Promovaný psycholog bez praxe, se znalostí anglického jazyka, hledá zaměstnání v oboru v celé ČR s možností ubytování. Zn.: Nadšenec pro obor

#### Se zdravotním omezením:

- Vyučená prodavačka drobného zboží se ZPS hledá zaměstnání v oboru na 6-ti hodinový pracovní úvazek v Mostě. Zn.: 30-ti letá alergie

### Telefonujeme zaměstnavatelům

Prakticky všichni zaměstnavatelé mají telefon a telefonní číslo obsahuje i většina nabídek pracovních příležitostí. Způsobem, jakým telefonicky jednáte se zaměstnavatelem, můžete mnoho získat, ale i ztratit. Nebude proto na škodu si některé z hlavních zásad připomenout.

#### Příprava telefonického hovoru

Připrav si hlavní body telefonátu, papír na poznámky a psací potřeby. Je vhodné mít přichystány osobní údaje, týkající se kvalifikace, praxe nebo přímo vlastní pracovní životopis, aby bylo možné pohotově reagovat na případné dotazy.

#### Cíle telefonického hovoru

Hlavním cílem je zaujmout zaměstnavatele a získat poznávání k osobnímu pohovoru. Na inzeráty většinou odpovídá více zájemců, je proto výhodné se od ostatních zájemců odlišit v dobrém smyslu již při telefonickém rozhovoru. Po ohlášení volaného by mělo následovat zřetelné představení. Poté by mělo následovat ujištění, že rozhovor probíhá s tou správnou osobou, která může tuto záležitost kompetentně vyřizovat. Následuje sdělení účelu telefonátu. Na otázky se doporučuje odpovídat stručně, věcně. Rozhovor ukončuje žádost o možnost zaměstnavatele osobně navštívit.

#### Kdy volat

Většinou není vhodné volat v době telefonní a pracovní špičky. Výhodnější bývá telefonovat hned na počátku pracovní doby.

#### Několik „samozřejmostí“ na závěr

Dovolat se ještě neznamená vyřídít. Volaný často není přítomen, jindy telefonát skončí u někoho jiného, je možné narazit na neochotnou spojovatelku, či sekretářku apod. Rozhodně není taktické začít rozhovor se zaměstnavatelem výtkou „...volám už podesáté...“ nebo „...už pět minut to u vás vyzvánělo...“. Volaný za neúspěšné pokusy nemůže a ani ho nezajímají.

Telefonický hovor je náhlý vpád do života často neznámého člověka. Není možné dopředu zjistit, jakou má zrovna náladu, práci nebo návštěvu. Proto se doporučuje mluvit stručně a brát ohled na jeho

čas, a také se přizpůsobit času schůzky, který zaměstnavatel navrhne. Pracovní rozvrh zaměstnaných lidí je nutné v této pozici respektovat.

Nejvýhodnější je průběžné zapisování výsledků telefonování a opakování nejdůležitějších údajů jako jsou jména, adresy, termíny, druhému účastníkovi a u těchto údajů si potom nechat potvrdit, že jim bylo správně rozuměno.

Není potřeba se bát používat telefon při hledání zaměstnání. Uspěje pouze ten, kdo zkouší.

## Připravujeme osobní dokumentaci

Téměř každý zájemce o práci, který se rozhodl kontaktovat zaměstnavatele, stojí před otázkou, jaké dokumenty mu přinést nebo poslat a jakou mají mít podobu.

První kontakt se rozhodně neobejde bez průvodního dopisu (žádost o zaměstnání), k němuž se přikládají pracovní životopis, kopie dokladů o kvalifikaci, případně i fotografie a doporučení.

Podklady, potřebné k sestavení osobní dokumentace:

- žádost (průvodní dopis)
- životopis
- fotografie
- vysvědčení
- doporučení

### Žádost o zaměstnání

Žádost má být výstižná a krátká a má obsahovat:

- přesnou a plnou adresu firmy
- oslovení
- vlastní text
- adresu a popř. telefonní číslo uchazeče
- seznam příloh

Podobná žádost, zvláště pokud se k ní přikládají další osobní dokumenty, slouží současně jako průvodní dopis. Stručně tedy vysvětlíte pohnutky, které vás vedly k tomu, že se zajímáte právě o tuto firmu či konkrétní volné místo. Protože zpravidla nevíte, kdo váš dopis bude číst, zvolte neutrální oslovení Vážení nebo Vážené dámy, vážení pánové. Dále se zmiňte o svých kvalifikačních přednostech, více bude obsahovat přiložený pracovní životopis.

Vzor žádosti o zaměstnání - viz následující strana:

Jana Bílá  
Moravská 45  
796 00 Prostějov  
tel. 755 263 542

Potraviny - velkoobchod  
Personální oddělení  
Žitná 12  
796 00 Prostějov

Prostějov 1.9.2003

Vážení,

Na základě Vašeho inzerátu v časopise „Práce“ ze dne 1.8.2003 se ucházím ve Vašem podniku o místo skladnice.

Životopis s dosavadním průběhem mé praxe příkládám, další informace poskytnu při osobním jednání, při němž bych se Vám ráda představila osobně.

S přátelským pozdravem

.....  
podpis (jen vlastnoruční)

**Přílohy**

- Životopis
- Fotografie
- Osvědčení o absolvování kurzu



## Profesní životopis (příklad)

### 1. Osobní údaje

Jméno a příjmení:	Hana Noyáková
Datum a místo narození:	1. listopadu 1978 v Mostě
Rodinný stav:	svobodná
Trvalé bydliště:	Zd. Fibicha 302/2704, 434 01 Most
Telefon:	476 102 367, 602 545 683
e-mail:	hananovakova@centrum.cz

### 2. Vzdělání

- 1999 - 2002 Střední odborné učiliště služeb Most (ukončeno výučním listem)

### 3. Pracovní praxe

- 2002 - 2003 Nákupní středisko Kaufland - obsluha masa a uzenin

### 4. Absolvované kurzy a školení

- řidičský průkaz skupiny „B“
- rekvalifikační kurz „Komunikační dovednosti“

### 5. Získané znalosti a dovednosti

- základní obsluha PC
- psaní na stroji

### 6. Zdravotní stav

- Dobrý

### 7. Reference

- Mgr. Jana Novotná, ředitelka SOU služeb Most, tel.: 652 348 957
- Jan Plánička, ředitel nákupního střediska Kaufland, tel.: 652 478 123
  
- zodpovědná, spolehlivá, samostatná
- komunikativní
- schopnost pracovat v týmu
- příjemné vystupování

V Mostě dne 25.6.2003

vlastnoruční podpis

## Sestavujeme pracovní životopis

Životopis je jedním z dokumentů, které zájemce prodávají. Jeho význam se zdůrazní tím, že bude součástí osobní dokumentace, kterou zájemce předává nebo zasílá zaměstnavateli. Důležitým požadavkem je přehlednost. Proto se doporučuje psát časově nebo věcně členěné, tzv. strukturované životopisy.

Pokuste se na chvíli vžít do role zaměstnavatele, kterému se podobných dokumentů najednou sejdou i několik desítek a musí je rychle prostudovat. Více než stylisticky dokonalý a květnatý text ocer životopis, ve kterém jsou osobní informace odděleny od údajů o vzdělání a dosavadní praxi.

Každý životopis má začínat základními osobními údaji - jménem, příjmením, datem a místem narození, přesnou adresou, případně s telefonním číslem nebo emailovou adresou. Rodinný stav a počet dětí se zde uvádět nemusí, to je vhodné nechat na osobní pohovor.

Následují údaje o vzdělání a kvalifikaci, které je lepší řadit v obrácené časové posloupnosti. Budoucího zaměstnavatele pochopitelně zajímá nejvíce nejvyšší dosažené vzdělání nebo poslední zaměstnavatel. Proto má příslušný odstavec životopisu těmito údaji začínat.

Do závěru patří další dovednosti nebo výjimečné znalosti, které by mohly být pro zaměstnavatele důležité (řidičské oprávnění, jazykové znalosti, znalost práce s PC apod.).

### Zásady pro zpracování životopisu - forma:

- měl by působit dobrým vizuálním dojmem
- měl by být psán na kvalitním psacím stroji nebo PC
- nejvhodnější je bílý papír formátu A4
- strukturovaný životopis (v bodech), používání odrážek, snaha o přehlednost
- spisovná čeština a terminologie vhodná pro daný obor (pozor na pravopis)
- neměl by být delší než na dvě strany

### Zásady pro zpracování životopisu - obsah:

- osobní údaje by se měly psát hned na začátku, jméno se uvádí celé, ne pouze iniciály, adresa se uvádí celá včetně PSČ, telefonního čísla, doporučuje se uvést i mobilní telefon a e-mailovou adresu
- při uvádění dosaženého vzdělání se začíná nejvyšším, uvádí se doba jednotlivých studií, typ školy, dosažené zkoušky, diplomy
- důležité jsou absolvované kurzy a školení vztahující se k vybrané profesi, životopis je možno aktualizovat a doplňovat podle příslušného místa, na které se klient hlásí
- je možné se také zmínit o zájmech, pozor, aby si zaměstnavatel nemyslel, že jich je příliš mnoho a nový pracovník se kvůli tomu nebude dostatečně věnovat své práci
- o zdravotním stavu se píše obecně, je možné uvést, i to kdy byla poslední preventivní prohlídka
- jestliže se váš klient hlásí na místo, kde jsou požadovány nějaké speciální dovednosti, radíme vám, abyste mu pomohli životopis sestavit (ušíť) na míru
- životopis musí být ukončen vlastnoručním podpisem, uvádí se místo a datum.

Při psaní životopisu i v průběhu osobního jednání se zaměstnavateli je výhodné používat formulace, které vzbuzují dobrý dojem a jsou pozitivní, např.:

- „sledovat vývoj oboru“
- „vyhledávat partnery pro spolupráci, získávat nové klienty a zákazníky“
- „reprezentovat firmu“
- „navrhovat a realizovat nové postupy, šetřit čas, energii, materiál“
- „úspěšně řešit neočekávané situace“
- „zpracovávat návrhy a řešení, podílet se na změnách výroby“
- „aktivně používat výpočetní techniku“
- „pracovat s důvěrnými informacemi“
- „ovládat zařízení, řídit auto, opravovat stroje“
- „vést korespondenci, sestavovat analýzy, tabulky, grafy“
- „jednat s lidmi, poskytovat informace atd.“

Součástí osobní dokumentace by měly být i aktuální fotografie pasového formátu. Nehodí se pocho-pitelně použít foto v plavkách z dovolené, pokud se ovšem klientka neuchází o místo manekýnky či modelky.

Poříd'te také fotokopie klientova posledního vysvědčení (diplomu, výučního listu apod.) a všech osvědčení o absolvovaných kurzech. Patří do materiálů, které se předávají firmě, u které se uchází o zaměstnání. Doporučte svému klientovi, aby si originály uložil do svého nebo rodinného archivu. V případě ztráty se obtížně získávají jejich duplikáty, neboť školy či jiná vzdělávací zařízení se mohou změnit, sloučit i zaniknout.

Doporučujeme také vytvoření vašeho vlastního archivu fotokopií těchto dokumentů. Klient ovšem musí se zařazením svých materiálů do vašeho archivu souhlasit.

Proberte s klientem písemné doporučení (reference) od někoho, kdo ho zná. To znamená jména a způsob kontaktu na osoby, které se o něm mohou vyjádřit, které jej mohou doporučit. Ale pozor! Reference uvádějte pouze tehdy, jste-li si jisti, že hodnocení dotyčnou osobou bude kladné. Neodvolávat se na osoby, k nimž má klient příbuzenský vztah. Písemné reference by měly být podepsány statutárním zástupcem organizace s uvedením jména, funkce a telefonické spojení.

Můžete to být např. vy nebo bývalý třídní učitel, mistr odborného výcviku, případně pracovník firmy. Jinak požádejte tuto osobu alespoň o podání ústních referencí v případě, že je kontakt na ně uveden na konci pracovního životopisu a zaměstnavatel se bude chtít informovat.

### Osobní dotazník

Bývá většinou strukturován do určitých celků, které vypovídají o úsecích profesního života a o osobnosti uchazeče. Formulář dotazníku si každý podnik může volit individuálně. Záleží na něm, jak podrobné informace chce.

Příjmení a jméno .....
Rodné příjmení .....
Místo narození .....
Datum narození .....
Rodné číslo .....
Rodinný stav .....
Státní příslušnost .....
Číslo OP .....
Zdravotní pojišťovna .....
Adresa trvalého bydliště, PSČ .....
Telefon .....
Adresa přechodného bydliště, PSČ .....
Telefon .....
Vzdělání a kvalifikace: .....
Základní .....
Střední: .....
• odborné .....
• úplné .....
• úplné odborné .....
• vyšší odborné .....
Průběh dosavadního zaměstnání .....
Rodinní příslušníci a ostatní vyživované osoby .....
Zdravotní stav .....
Důchod - druh .....
Stanovené srážky ze mzdy .....
Soudní trestní řízení nebo zákaz činnosti - důvod .....
Peněžní ústav, druh účtu, číslo účtu, kód banky, specifický symbol .....
Datum .....
Podpis .....



PANI KARLÍKOVÁ TELEFONUJE / PAN KOUBA TELEFONUJE

PANI KARLÍKOVÁ TELEFONUJE S PANEM KOUBOU

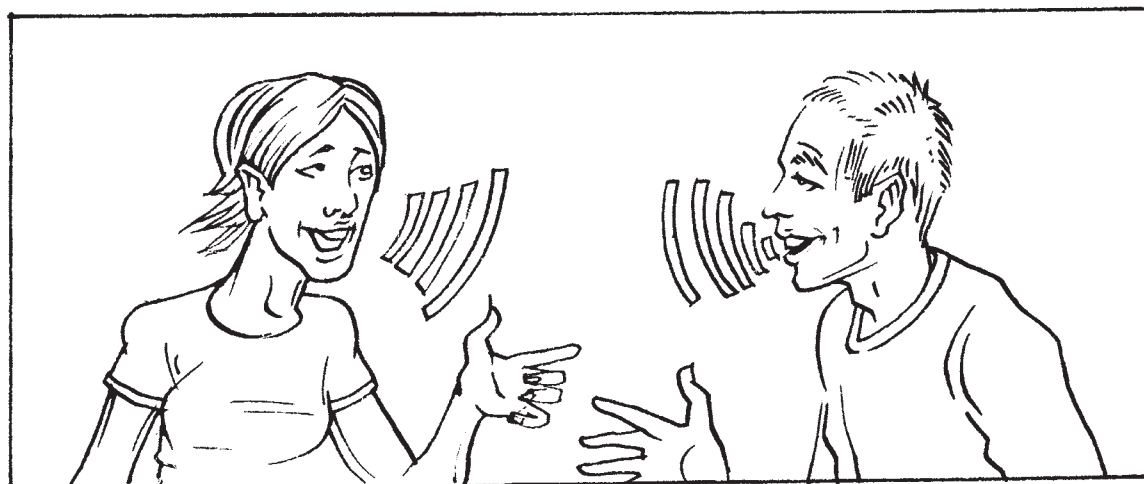

JANA MLUVÍ

PETR MLUVÍ

JANA MLUVÍ S PETEREM

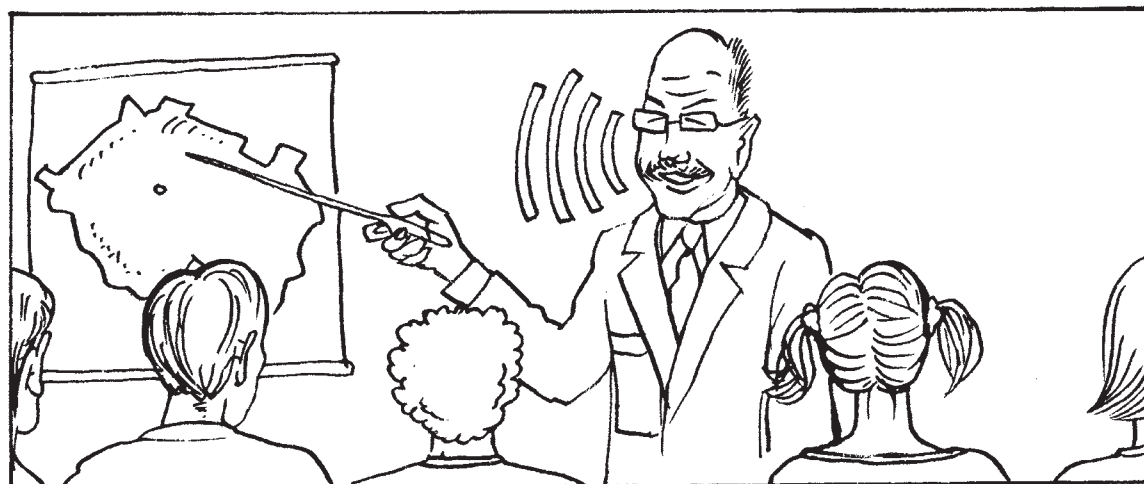

PAN UČITEL MLUVÍ

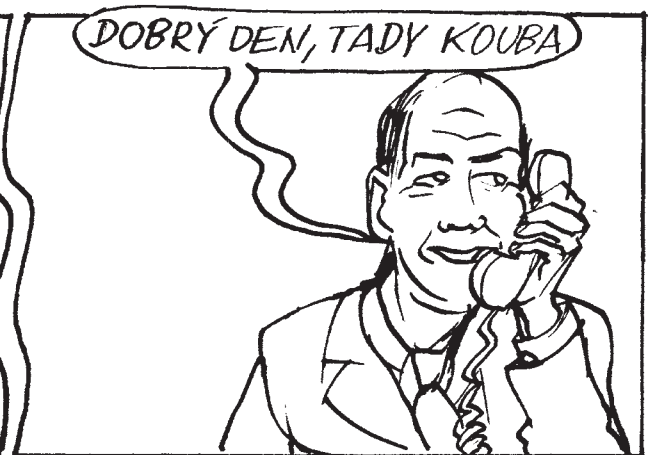

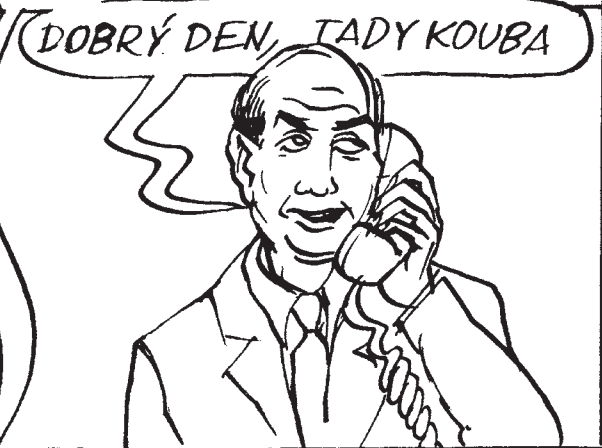









POLICIE

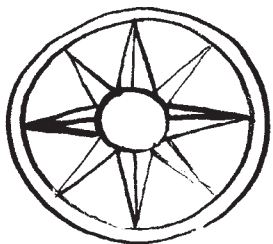

☎ 158

HASIČI

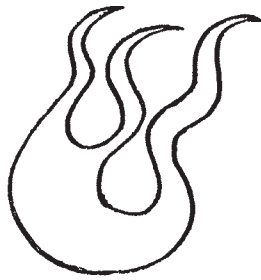

☎ 150

ZÁCHRANA  
SLUŽBA

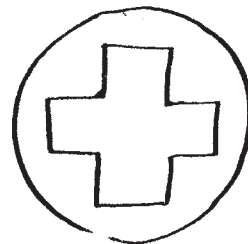

☎ 155

JAKÉ ČÍSLO ZAVOLÁTE?



MÁTE TELEFON?



MOCT

CHTÍT

JÁ	MŮŽU	CHCI
TY	MŮŽEŠ	CHCEŠ
ON, ONA, ONO	MŮŽE	CHCE
MY	MŮŽEME	CHCEME
VY	MŮŽETE	CHCETE
ONI	MŮŽOU	CHTĚJÍ

MOCT

CHTÍT

JÁ	MŮŽU	CHCI
TY	MŮŽEŠ	CHCEŠ
ON, ONA, ONO	MŮŽE	CHCE
MY	MŮŽEME	CHCEME
VY	MŮŽETE	CHCETE
ONI	MŮŽOU	CHTĚJÍ

MOCT

CHTÍT

JÁ	MŮŽU	CHCI
TY	MŮŽEŠ	CHCEŠ
ON, ONA, ONO	MŮŽE	CHCE
MY	MŮŽEME	CHCEME
VY	MŮŽETE	CHCETE
ONI	MŮŽOU	CHTĚJÍ

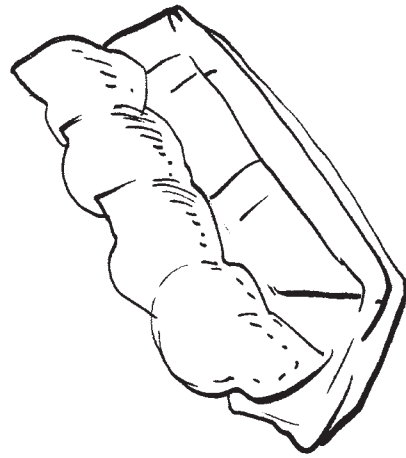
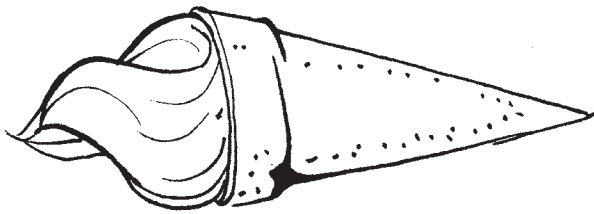
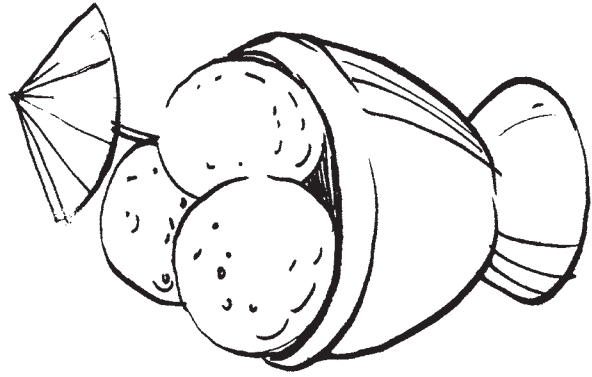
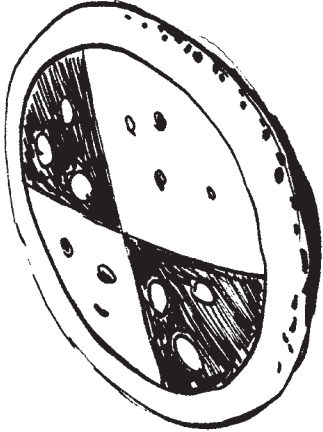
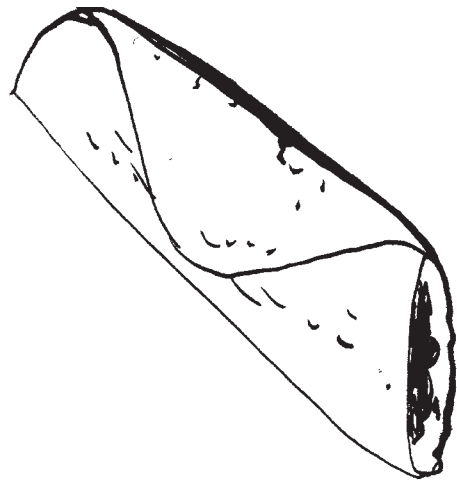
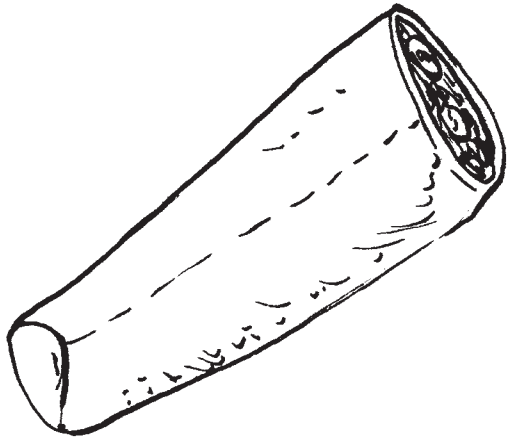

JABLEČNÝ  
ZÁVIN

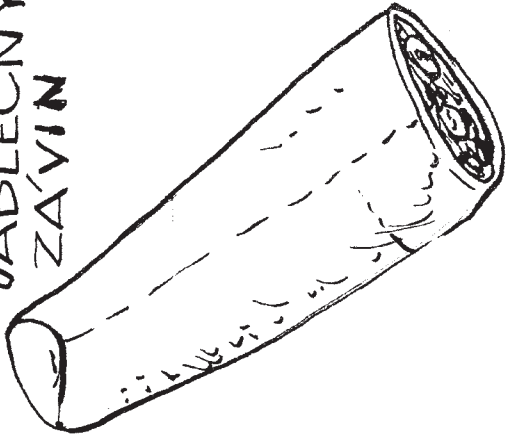

PALAIČKA

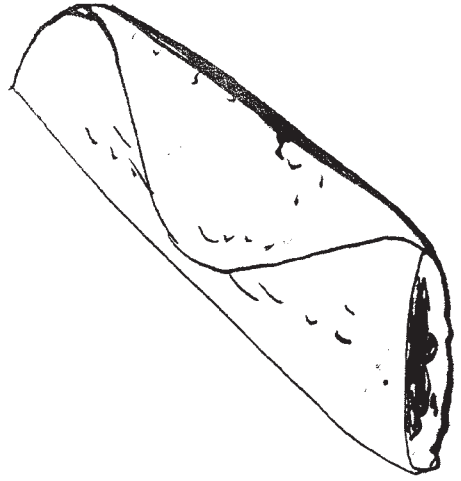

KOLAČ

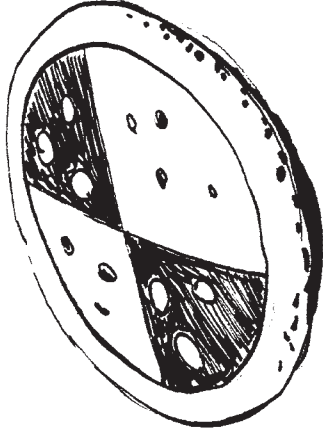

ZMRZLINOVÝ  
POHÁŘ

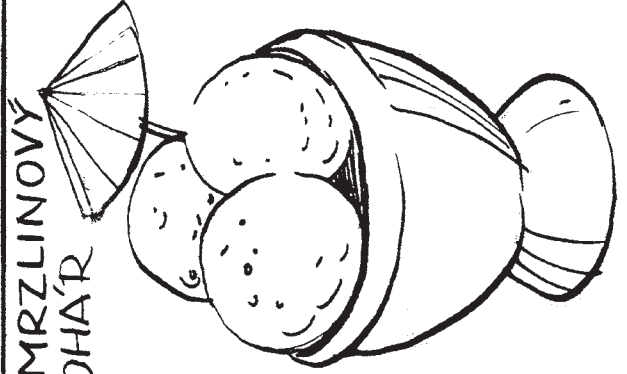

ZMRZLINA

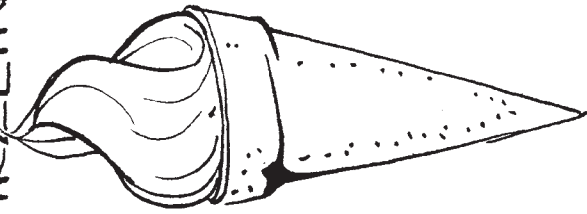

RAKYIČKA  
SE ŠLEHAČKOU

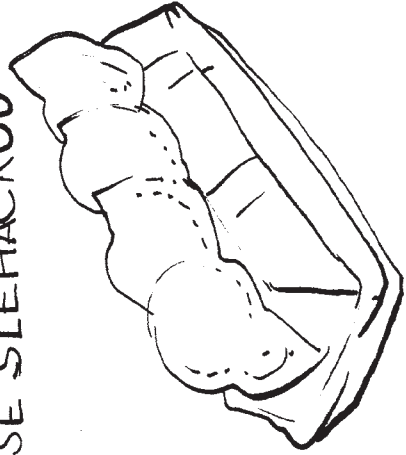

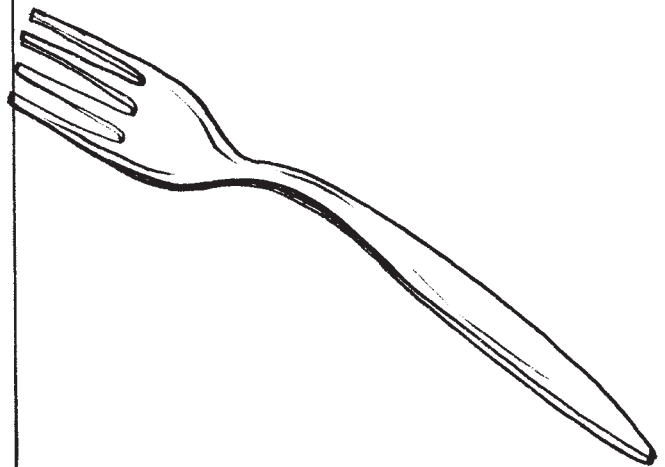
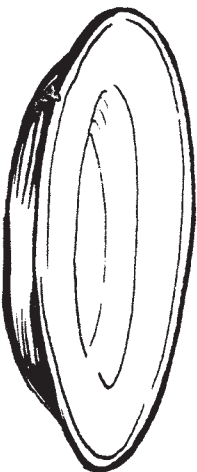
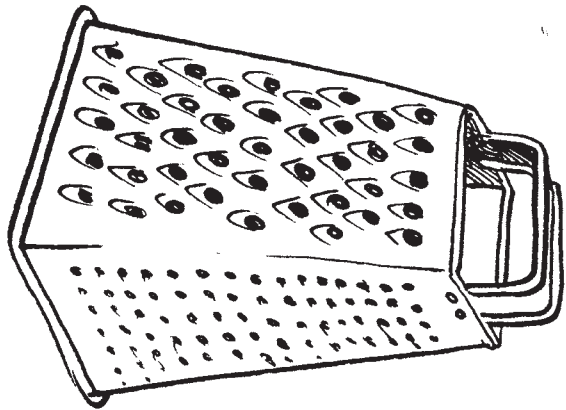
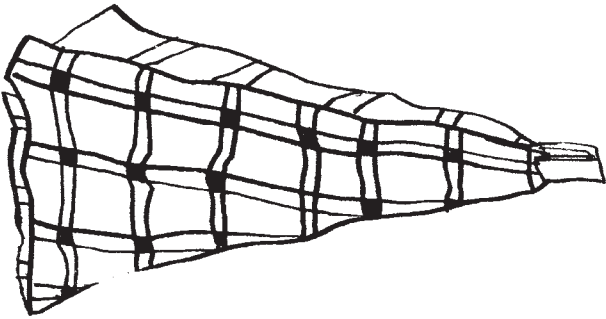
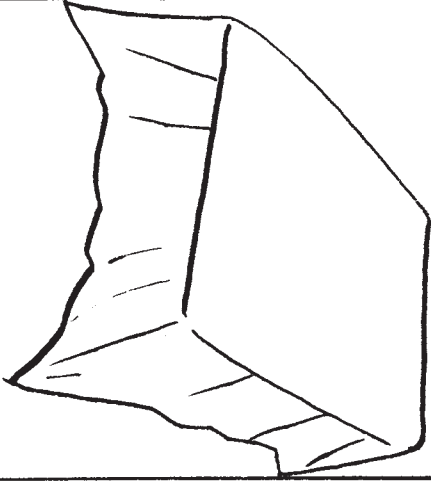
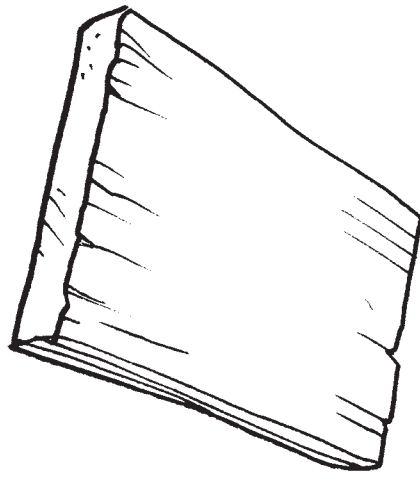
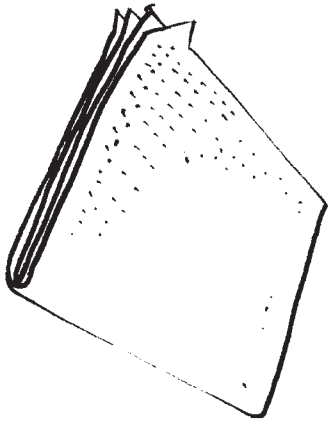

PRKÝŇKO

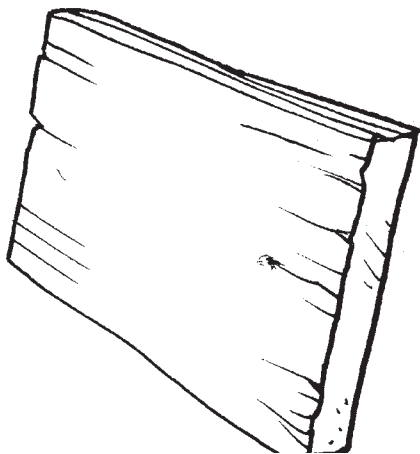

SKLENICE



STRUHADLO

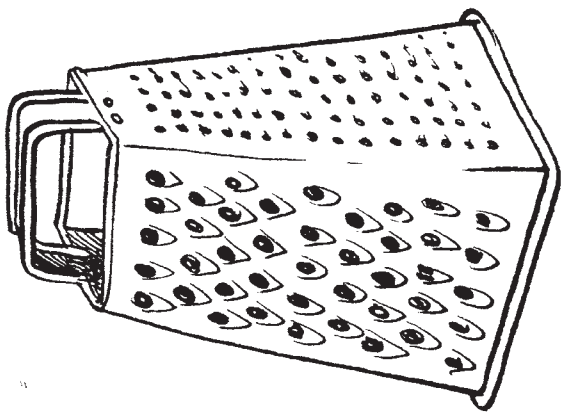

VIDLIČKA

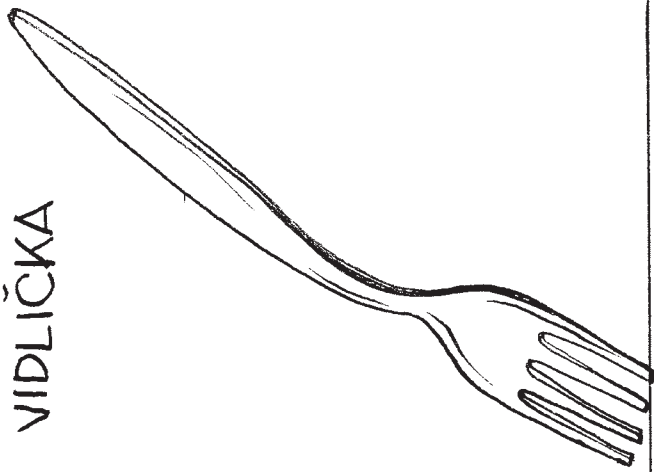

UBROUSEK

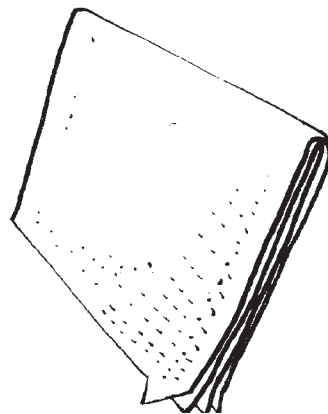

UBRUS

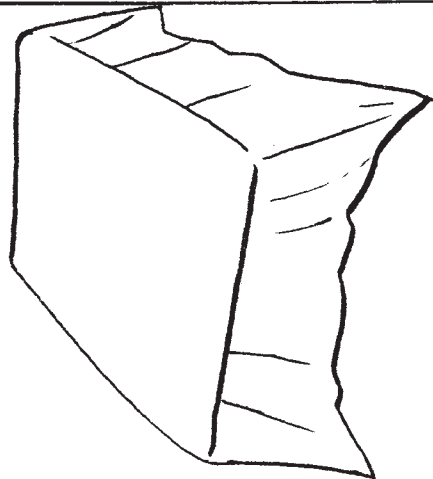

UTĚRKA

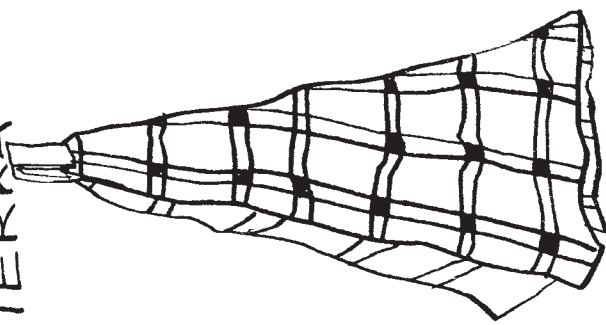

TALÍŘ

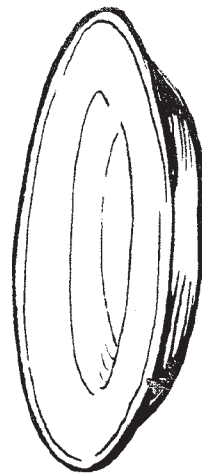

HRNEC

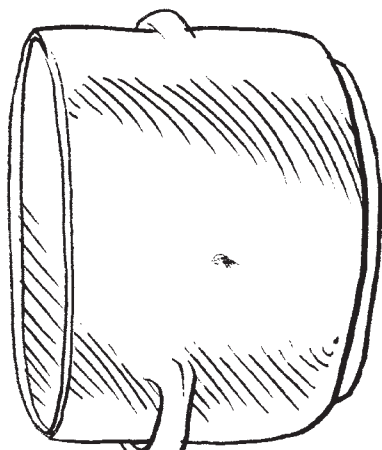

HRNEK



LŽÍCE

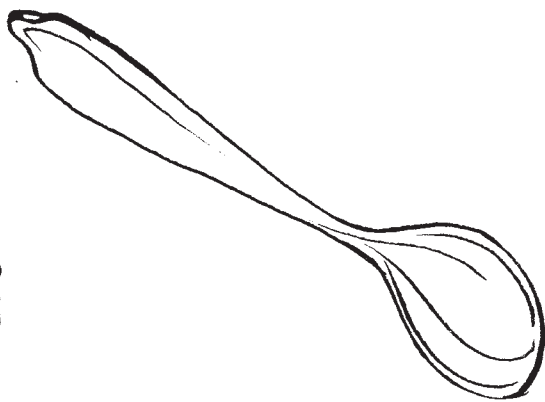

LŽIČKA

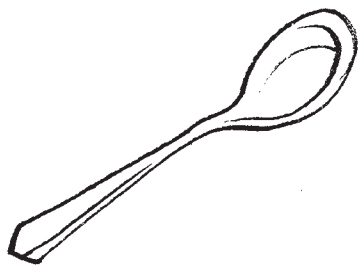

NABĚRAČKA



NUŽ

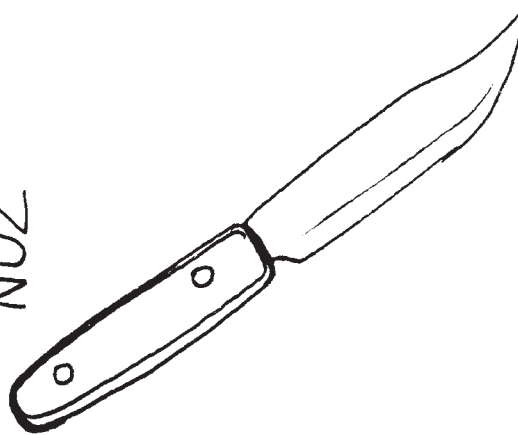

PAŇEV

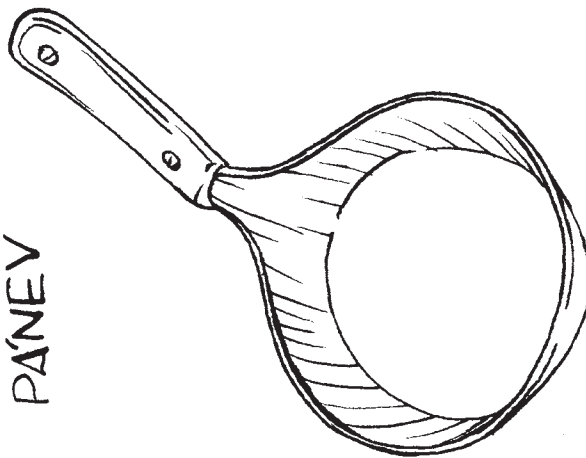

POKLICE

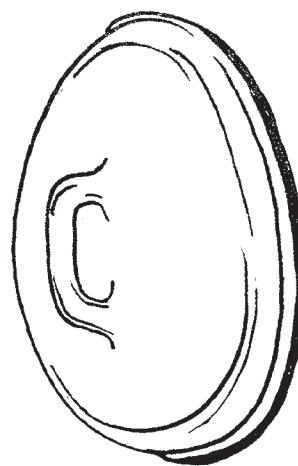



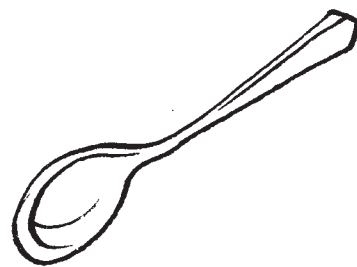
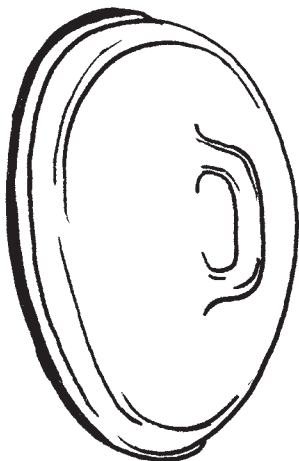
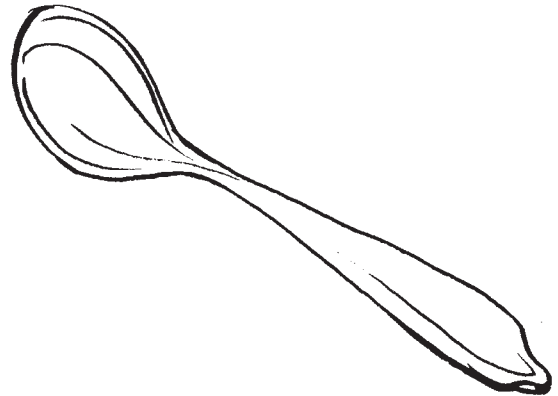
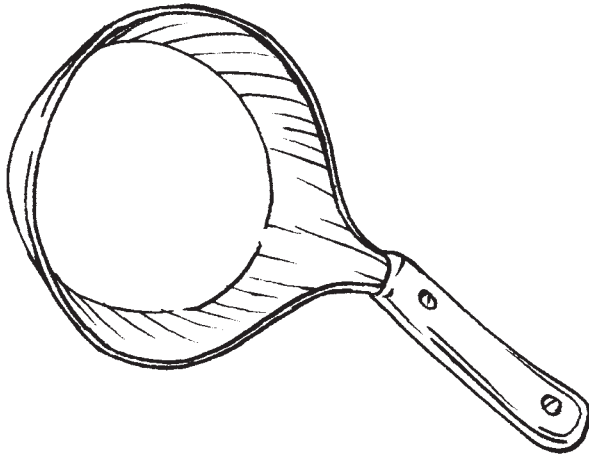
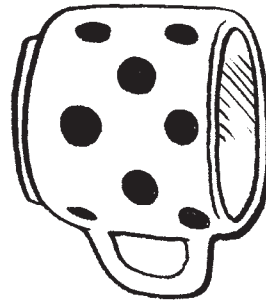
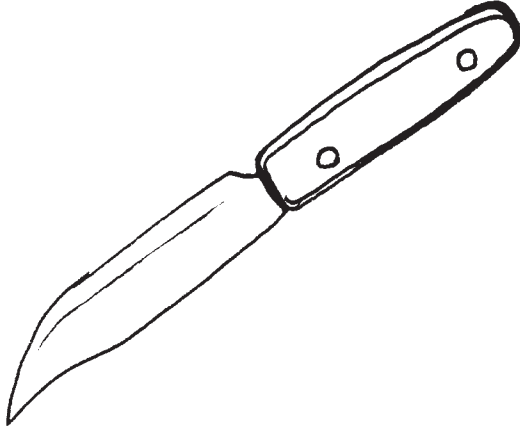
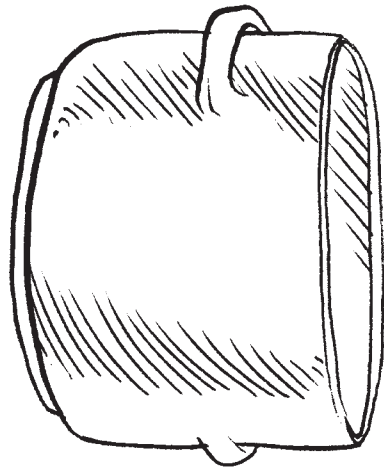
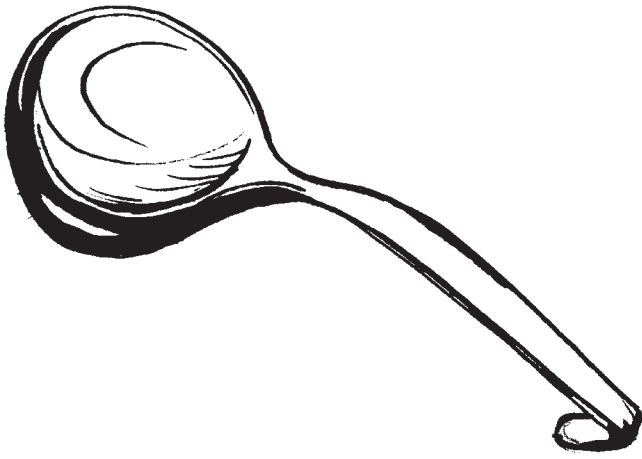

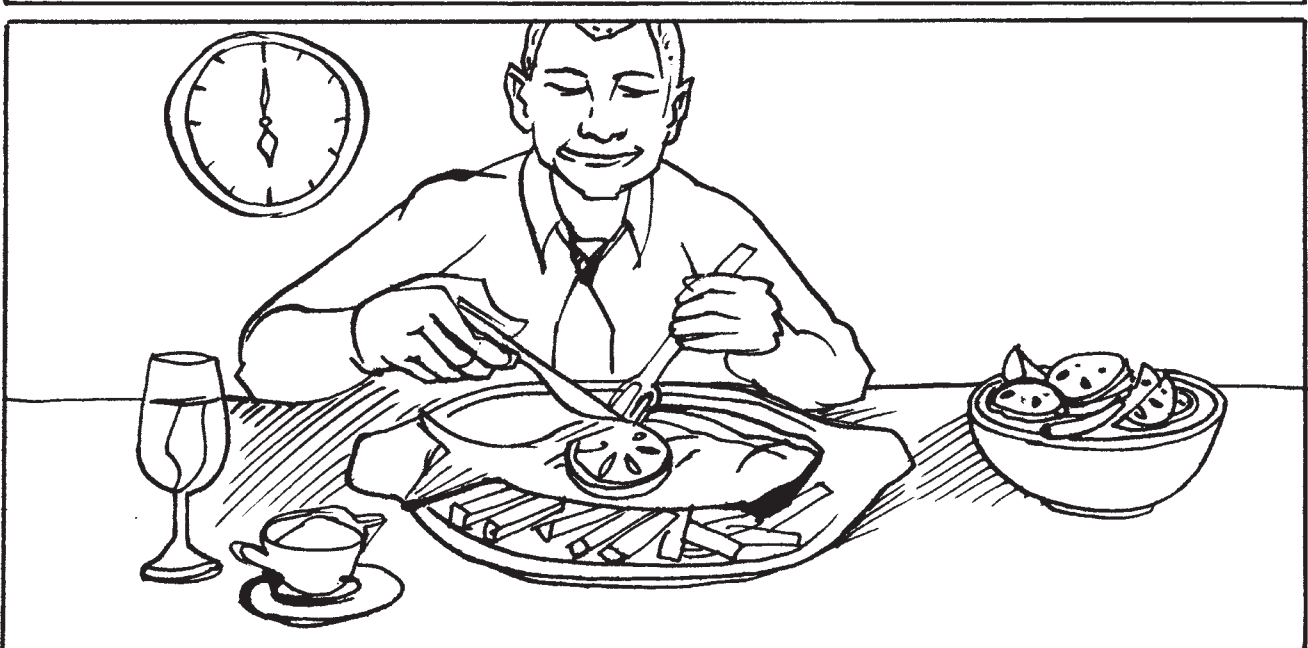
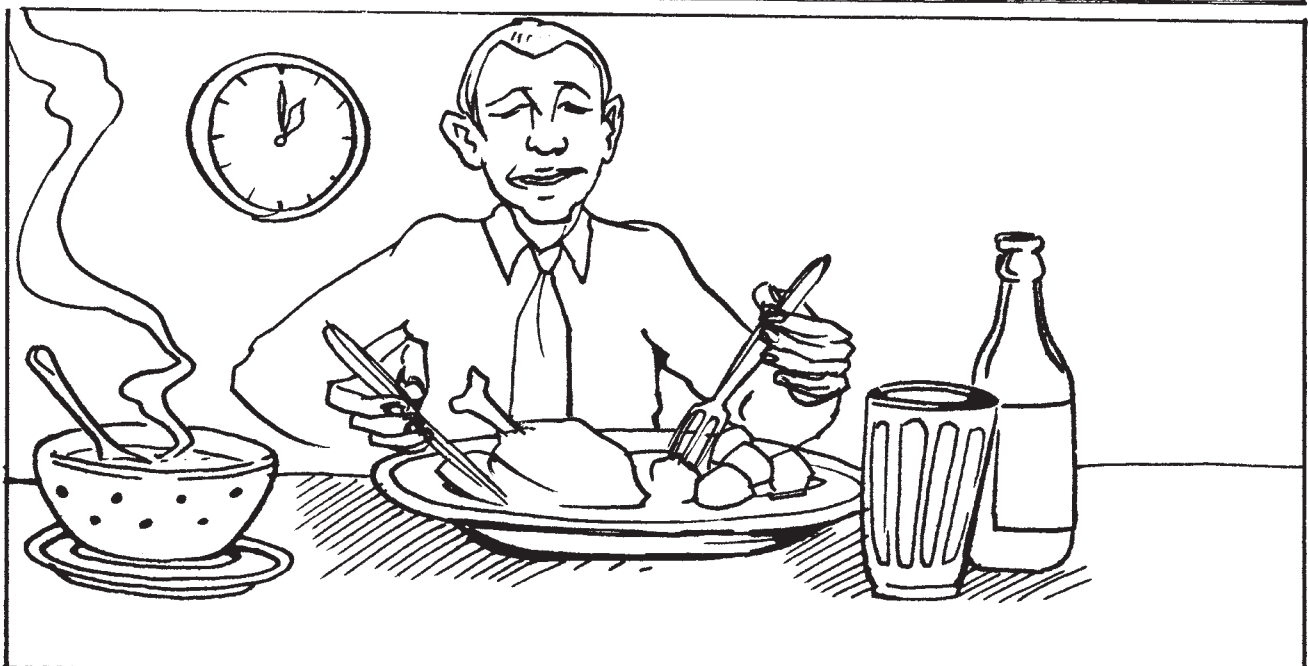
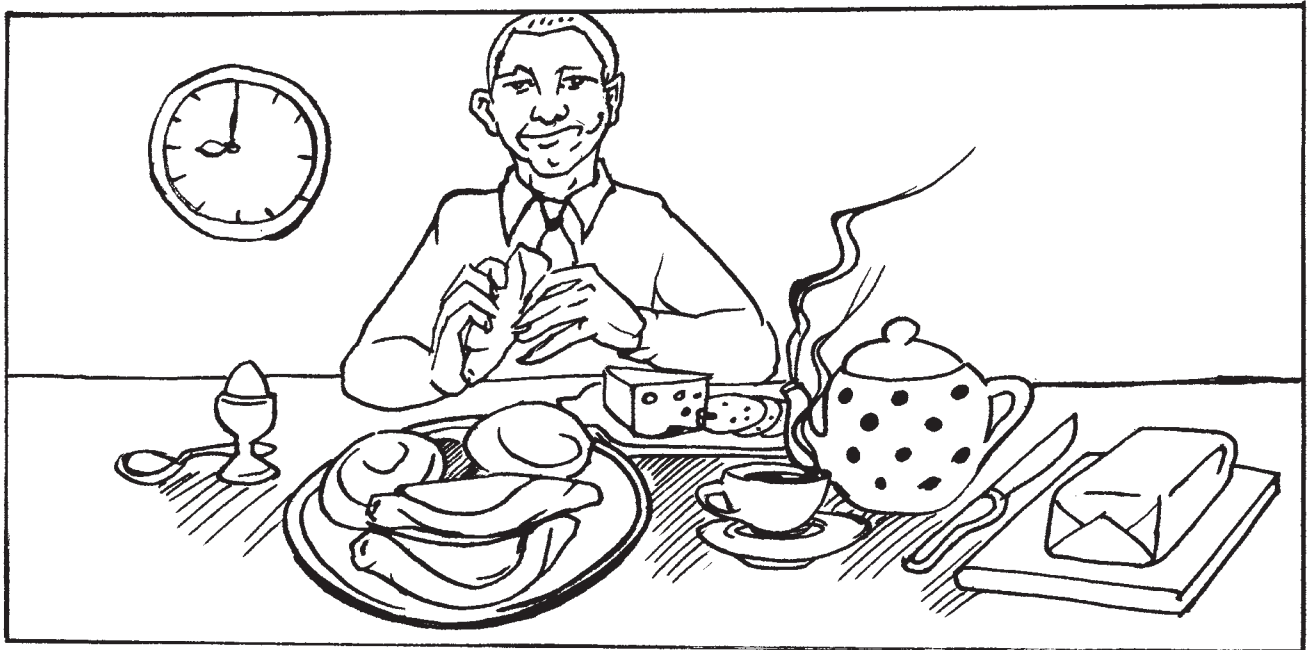

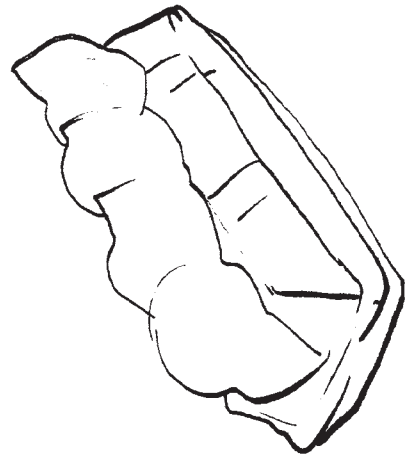
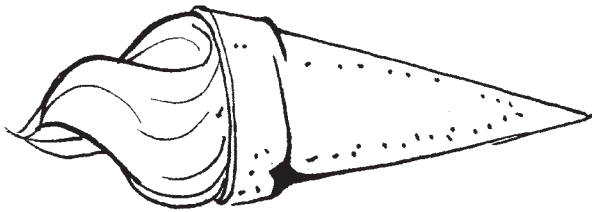
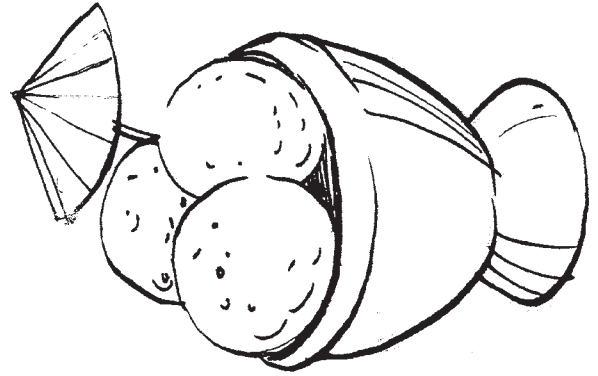
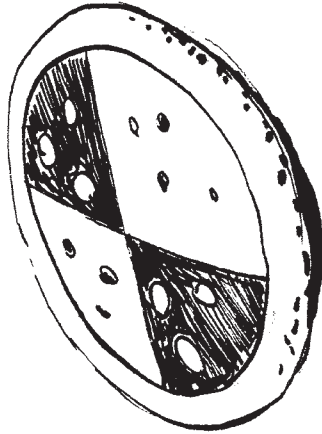
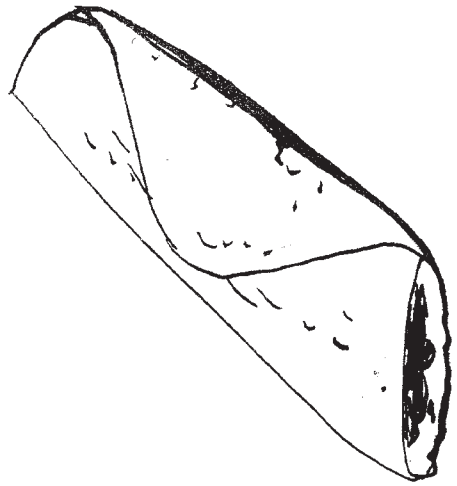
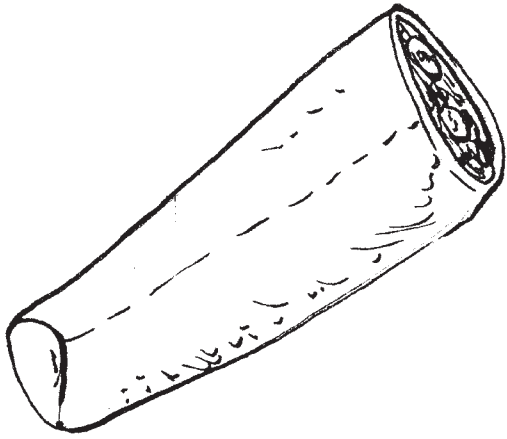







## JÍDELNÍ LÍSTEK

restaurace U Nováků

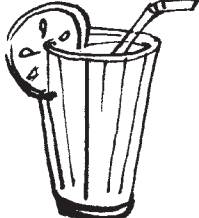
Polévky:	<p>Hovězí vývar          Kuřecí/drůbeží vývar          Bramborová polévka          Hrachová polévka          Gulášová polévka</p>		
Hlavní jídla:	<p>Hovězí guláš, knedlíky          Dušené hovězí, rýže          Vepřový řízek, brambory, zeleninová obloha          Pečené kuře, bramborová kaše, kompot          Pečená husa, bramborové knedlíky, zelí          Hovězí s rajskou omáčkou, houskové knedlíky          Karbanátek, bramborová kaše          Hovězí, brambory, špenát          Svíčková pečeně na smetaně, houskové knedlíky</p>		
Bezmasá jídla:	<p>Smažený sýr, brambory, tatarská omáčka          Omeleta s hráškem, brambory          Omeleta se žampiony, brambory          Špagety se sýrem          Dušená zelenina s vejcem, brambory          Ovocné knedlíky</p>		
Saláty:	<p>Zelný salát          Okurkový salát          Mrkvový salát          Míchaný salát          Šopský salát</p>		
Dezerty /zákusky:	<p>Čokoládový dort          Jablečný závin          Rakvička se šlehačkou          Zmrzlinový pohár          Ovocný pohár          Palačinky s ovocem a čokoládou</p>		
Teplé nápoje:	<p>Turecká káva          Espresso          Vídeňská káva          Čaj (černý, zelený, ovocný)          Grog          Horká čokoláda</p>		
Studené nápoje:	<p>Coca – cola, Sprite, 7 UP          Minerálka          Džus (pomerančový, jablečný, multivitamin)          Pivo          Červené víno          Bílé víno</p>		

#### Houskové knedlíky

Potřebujeme: 40 dkg mouky, 2 dkg másla, 1 vejce, 0.25 l mléka, 5 g soli, 3 housky

Nádobí: mísa, hrnec, prkýnko, nůž, lžíce

Housky nakrájíme na kostky. Do mísy dáme mouku, mléko, vejce, sůl a uděláme těsto. Nakonec tam dáme housky a zamícháme do těsta. Z těsta uděláme dva dlouhé knedlíky. Knedlíky dáme do vařící vody a vaříme 25 min. Hotové knedlíky vyndáme z vody a nakrájíme.

#### Houskové knedlíky

Potřebujeme: 40 dkg mouky, 2 dkg másla, 1 vejce, 0.25 l mléka, 5 g soli, 3 housky

Nádobí: mísa, hrnec, prkýnko, nůž, lžíce

Housky nakrájíme na kostky. Do mísy dáme mouku, mléko, vejce, sůl a uděláme těsto. Nakonec tam dáme housky a zamícháme do těsta. Z těsta uděláme dva dlouhé knedlíky. Knedlíky dáme do vařící vody a vaříme 25 min. Hotové knedlíky vyndáme z vody a nakrájíme.

#### Houskové knedlíky

Potřebujeme: 40 dkg mouky, 2 dkg másla, 1 vejce, 0.25 l mléka, 5 g soli, 3 housky

Nádobí: mísa, hrnec, prkýnko, nůž, lžíce

Housky nakrájíme na kostky. Do mísy dáme mouku, mléko, vejce, sůl a uděláme těsto. Nakonec tam dáme housky a zamícháme do těsta. Z těsta uděláme dva dlouhé knedlíky. Knedlíky dáme do vařící vody a vaříme 25 min. Hotové knedlíky vyndáme z vody a nakrájíme.

#### Houskové knedlíky

Potřebujeme: 40 dkg mouky, 2 dkg másla, 1 vejce, 0.25 l mléka, 5 g soli, 3 housky

Nádobí: mísa, hrnec, prkýnko, nůž, lžíce

Housky nakrájíme na kostky. Do mísy dáme mouku, mléko, vejce, sůl a uděláme těsto. Nakonec tam dáme housky a zamícháme do těsta. Z těsta uděláme dva dlouhé knedlíky. Knedlíky dáme do vařící vody a vaříme 25 min. Hotové knedlíky vyndáme z vody a nakrájíme.



JET nebo JÍT?

1. Dnes večer ..... do restaurace. (já)
2. V pátek ..... do Brna. (my)
3. Kdy ..... vlakem na výlet? (ty)
4. Petr a Pavel ..... do kina.
5. Jak ..... do Bratislavy? Vlakem nebo autobusem? (vy)
6. Martin ..... na oběd do restaurace.
7. Kdo ..... na policii.
8. Večer ne ..... do kina, ale ..... na koncert. (já)
9. Tramvaj ne ....., musíme ..... pěšky. (my)
10. V kolik hodin ..... vlak do Ostravy?

JET nebo JÍT?

11. Dnes večer ..... do restaurace. (já)
12. V pátek ..... do Brna. (my)
13. Kdy ..... vlakem na výlet? (ty)
14. Petr a Pavel ..... do kina.
15. Jak ..... do Bratislavy? Vlakem nebo autobusem? (vy)
16. Martin ..... na oběd do restaurace.
17. Kdo ..... na policii.
18. Večer ne ..... do kina, ale ..... na koncert. (já)
19. Tramvaj ne ....., musíme ..... pěšky. (my)
20. V kolik hodin ..... vlak do Ostravy?

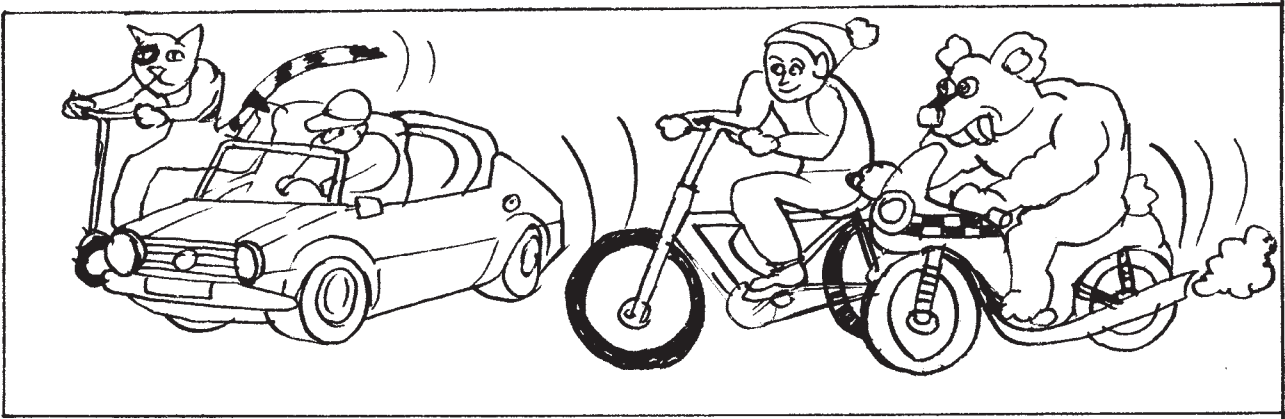



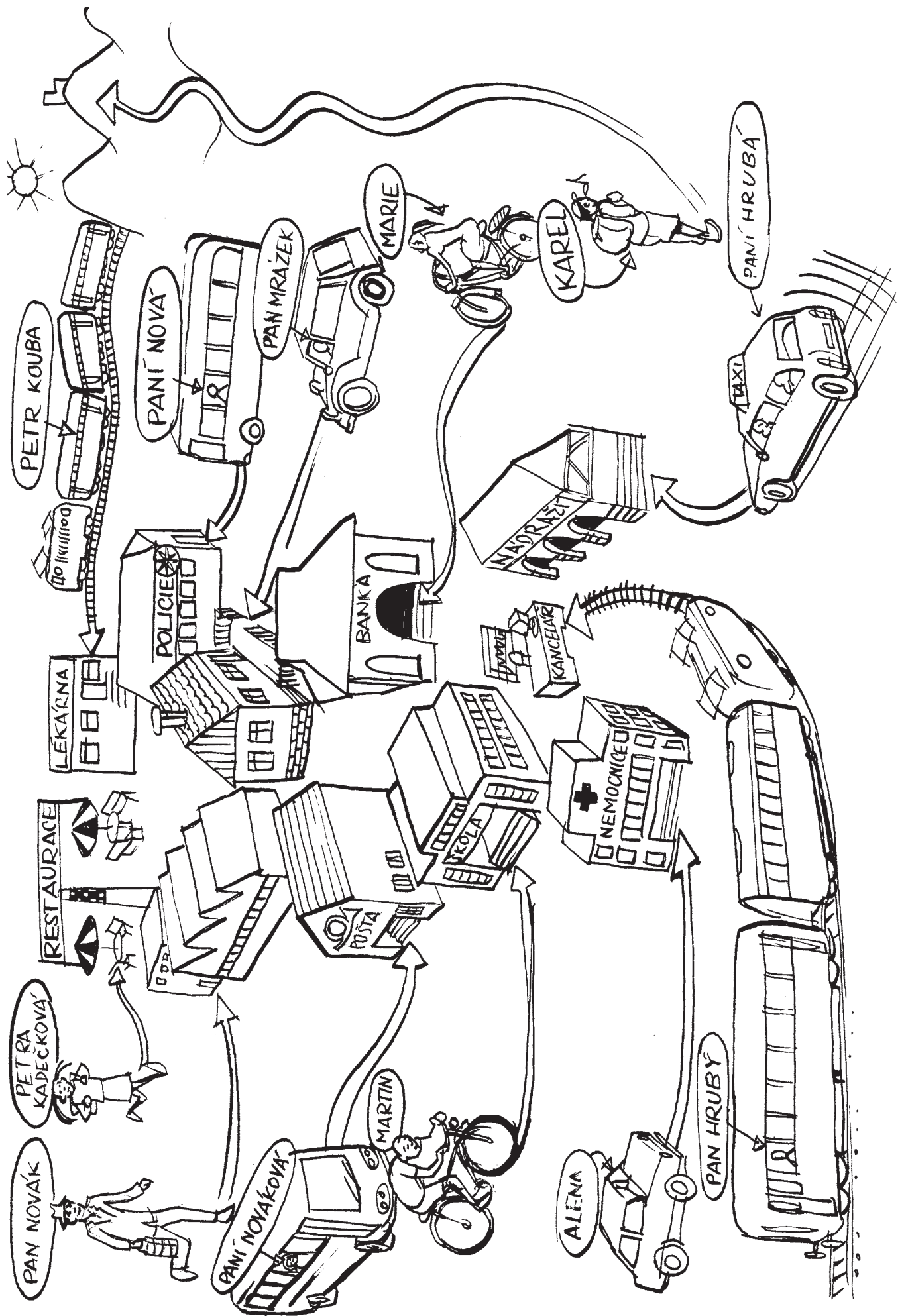

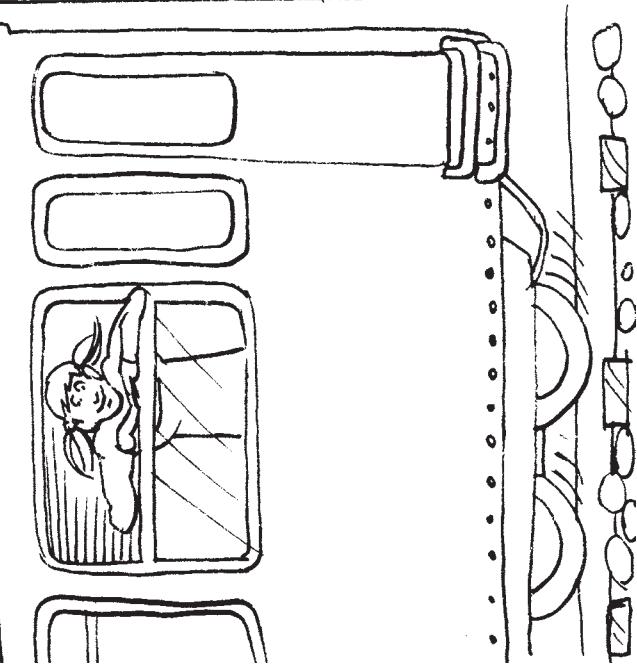
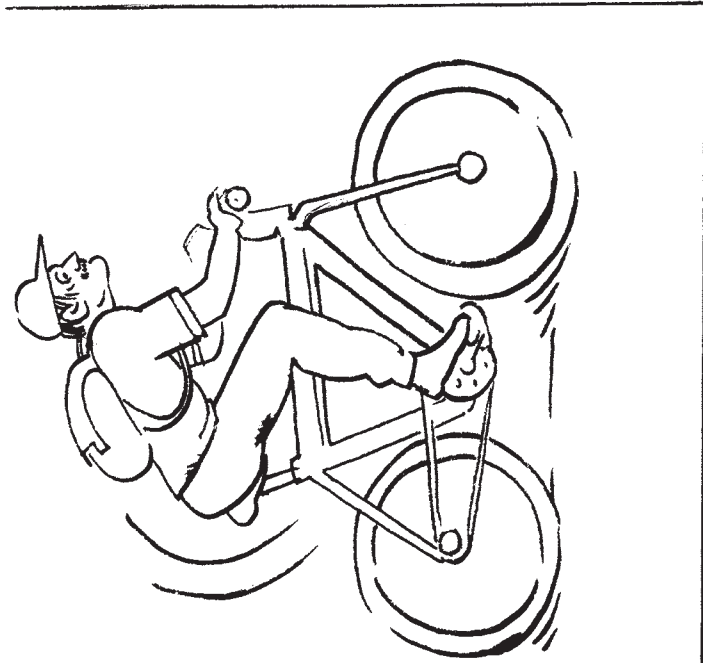
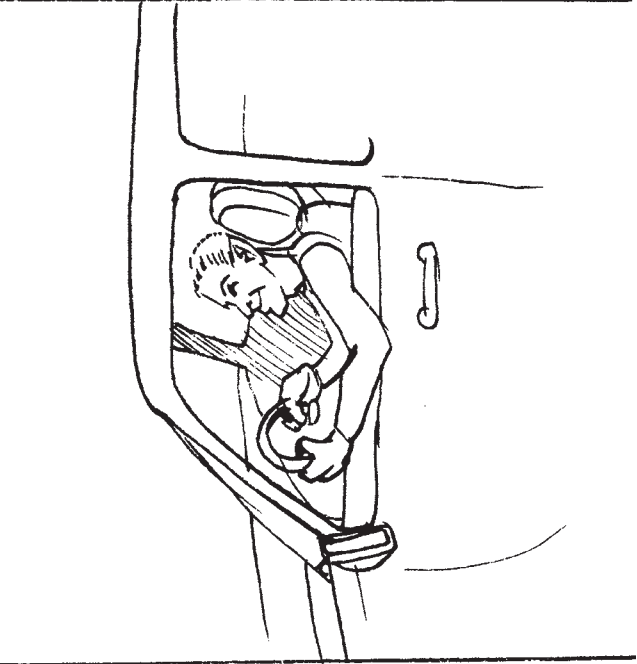
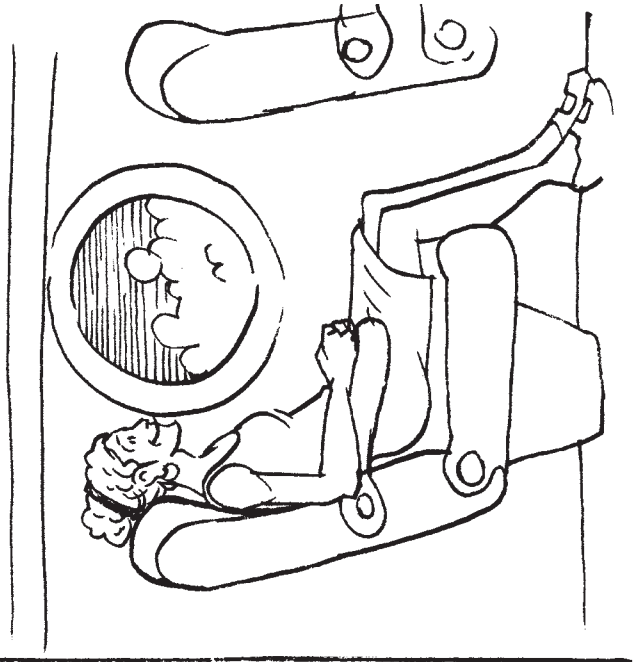
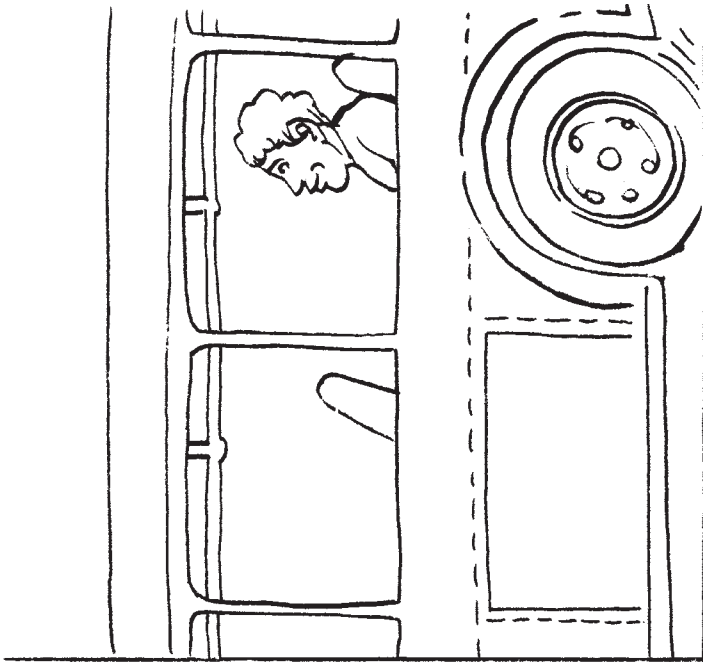

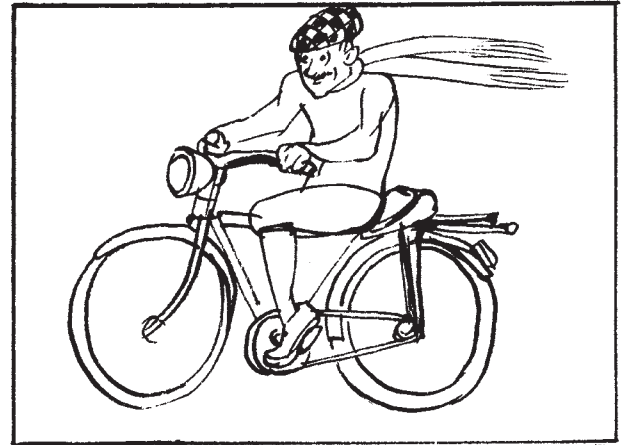
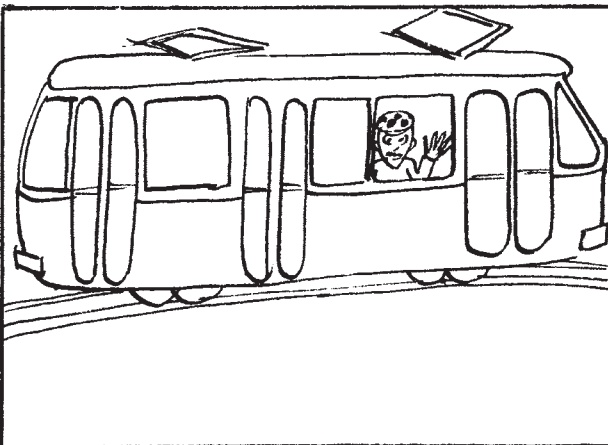
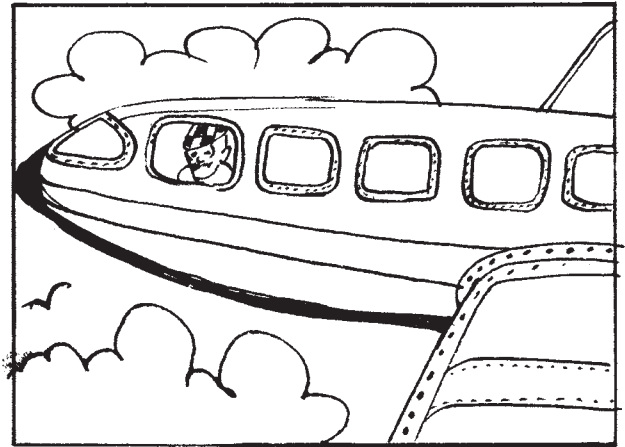
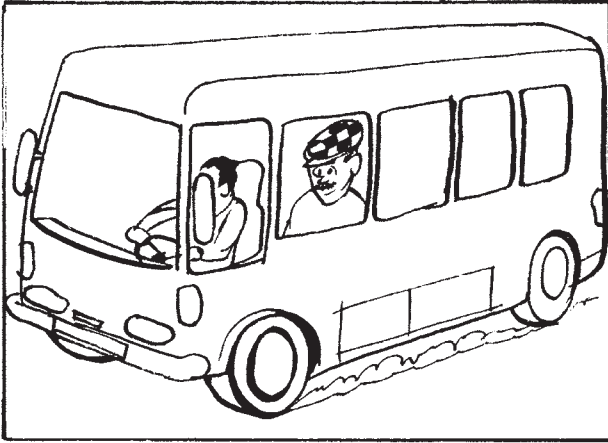
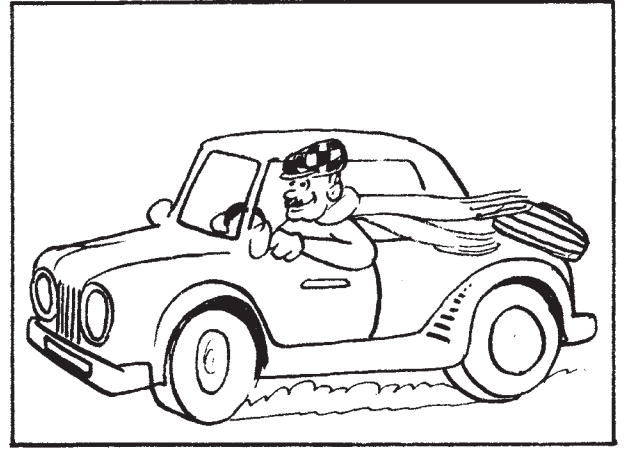
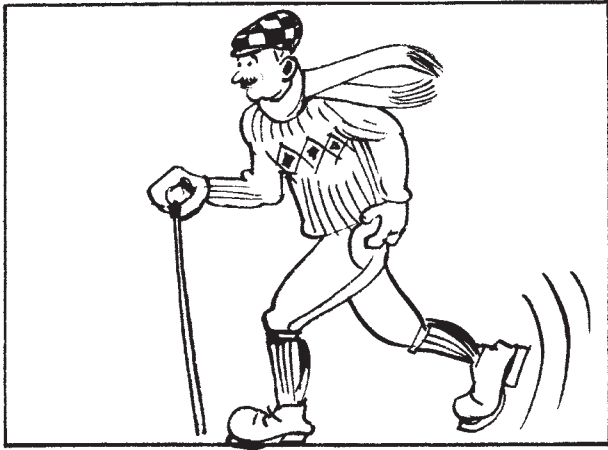

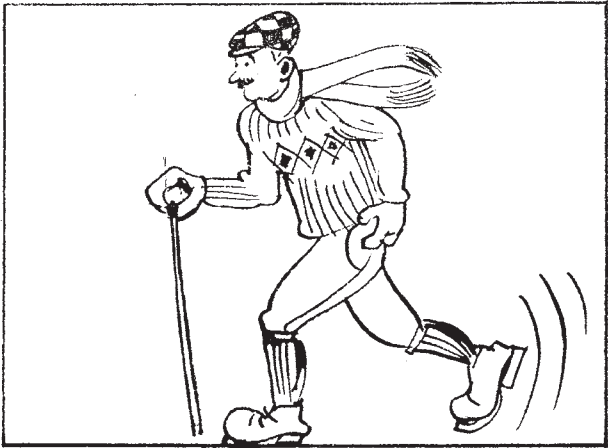

JDE PĚŠKY

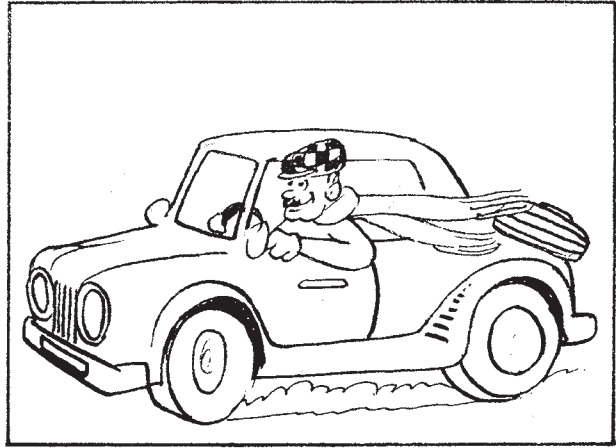

JEDE AUTEM

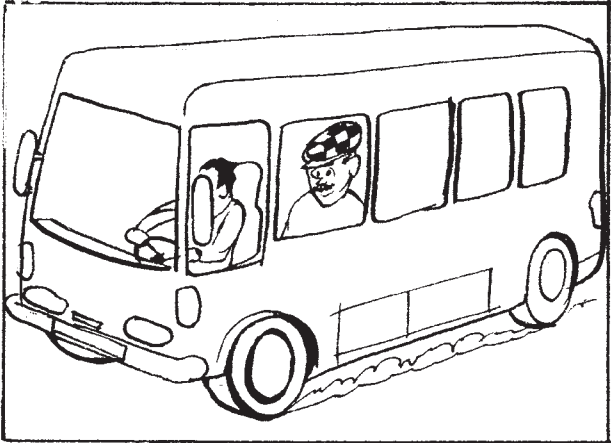

JEDE AUTOBUSEM



JEDE VLAKEM



JEDE TAXIKEM

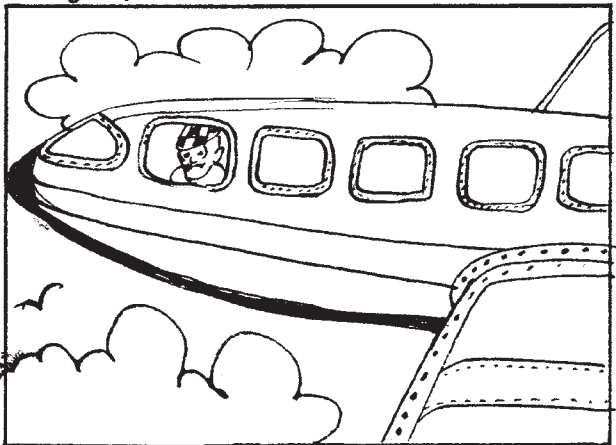

LETÍ LETADLEM

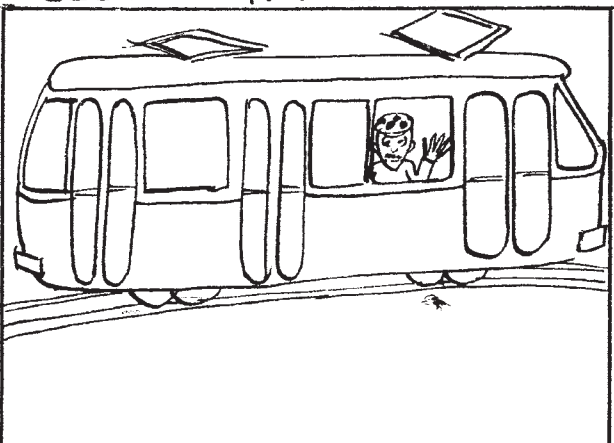

JEDE TRAMVAJÍ

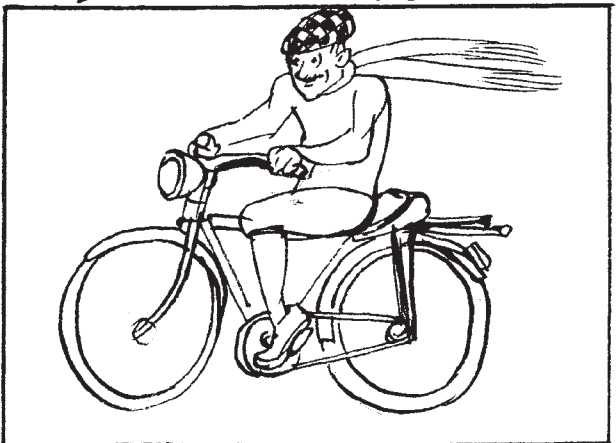

JEDE NA KOLE

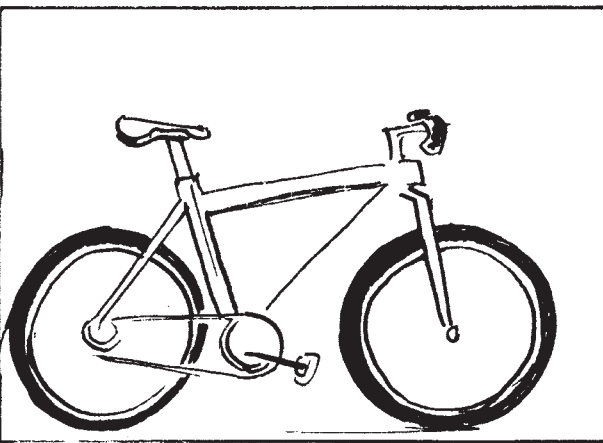
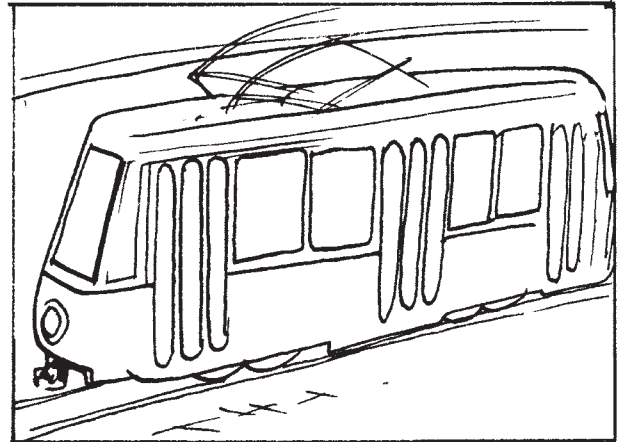
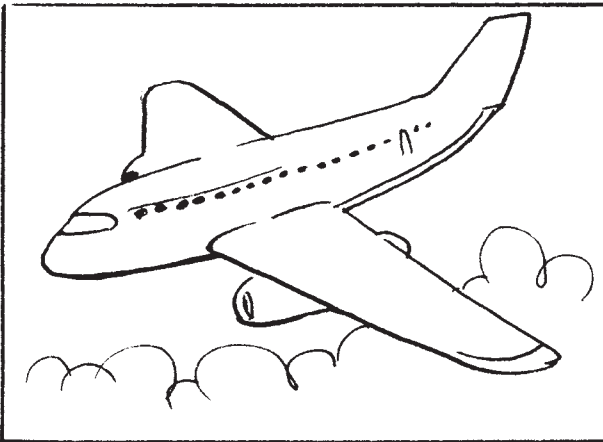
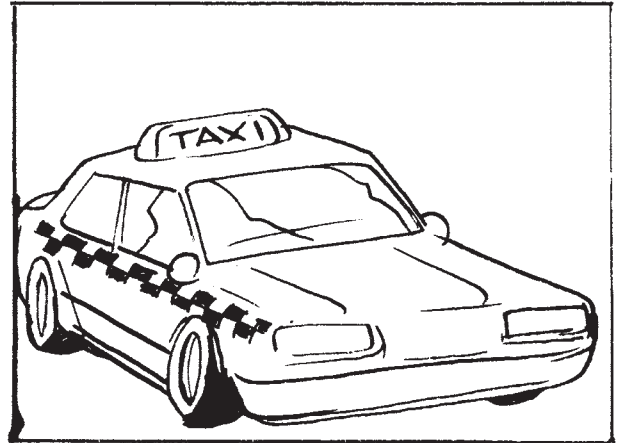
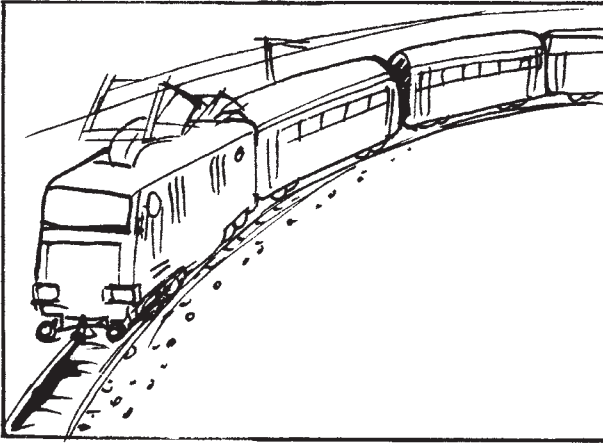
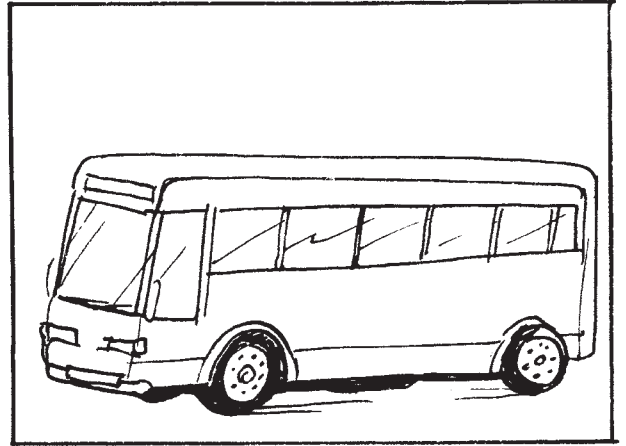
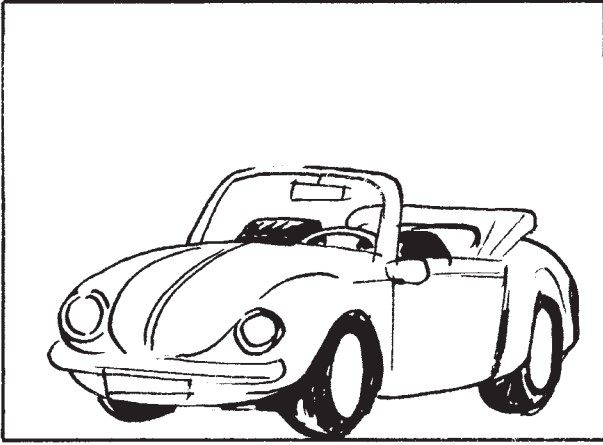



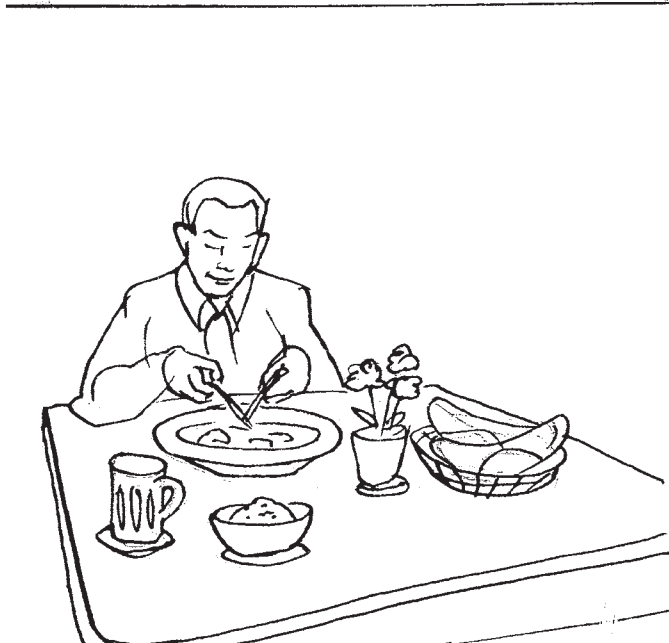
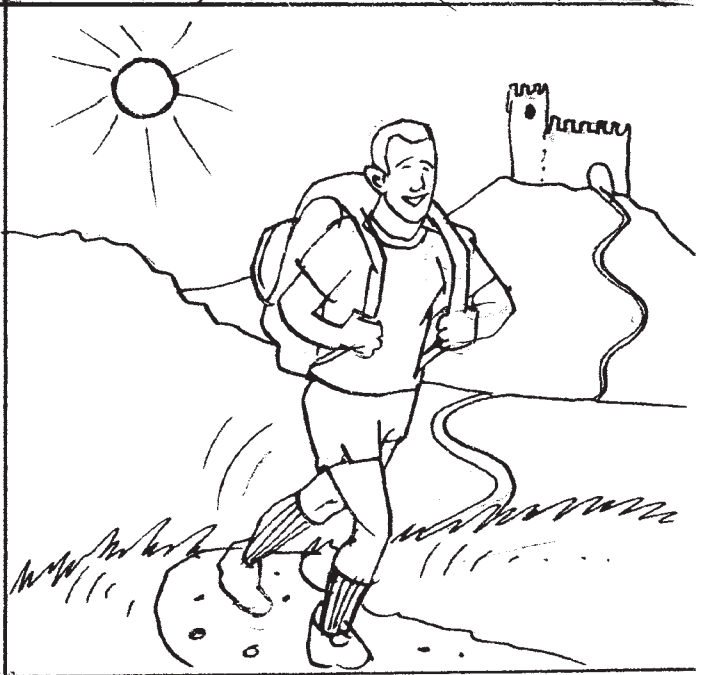

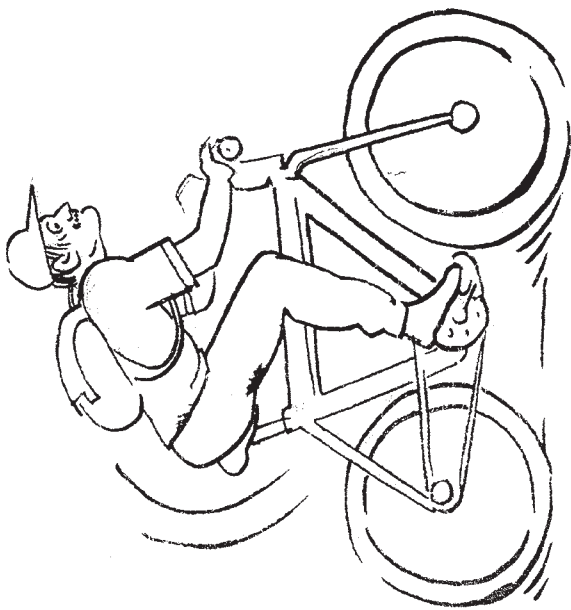

JEDE NA KOLE

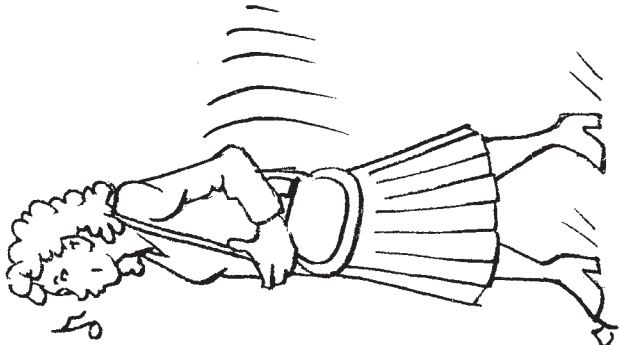

JDE PĚŠKY

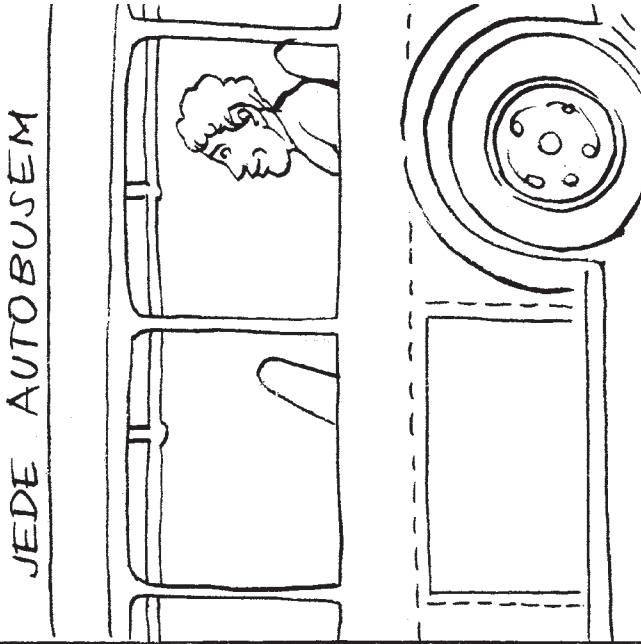

JEDE AUTOBUSEM



JEDE VLAKEM

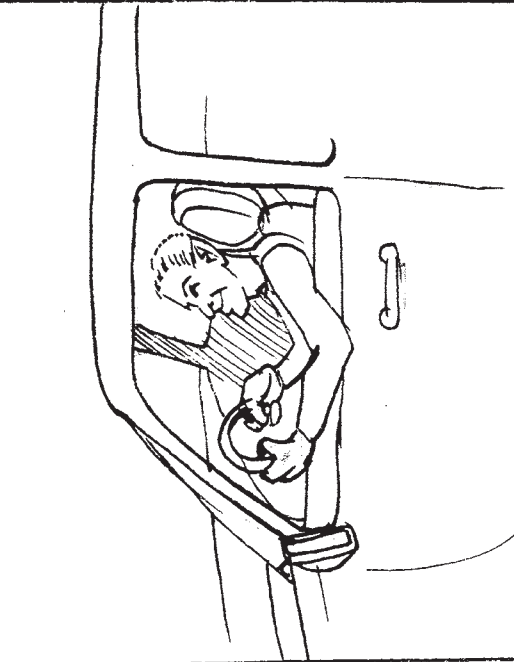

JEDE AUTEM

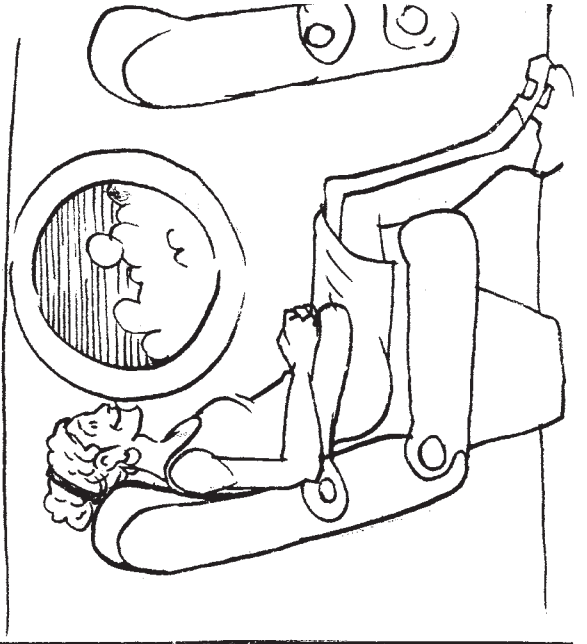

LETÍ LETADLEM

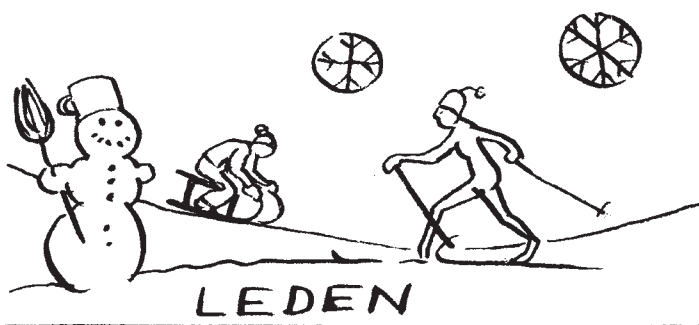

LEDEN

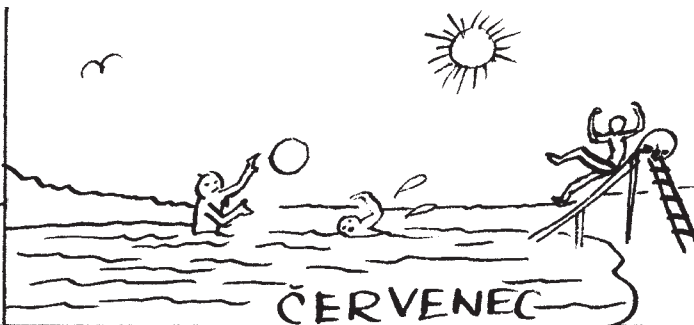

ČERVENEC

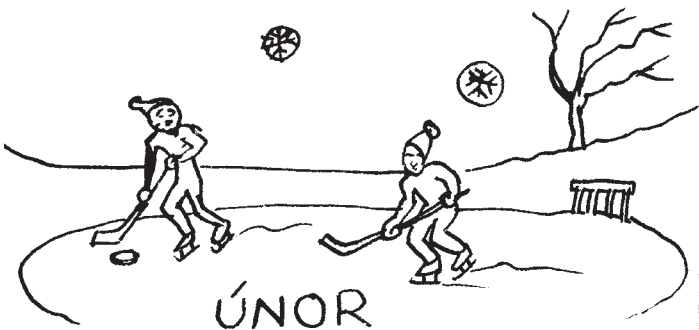

ÚNOR

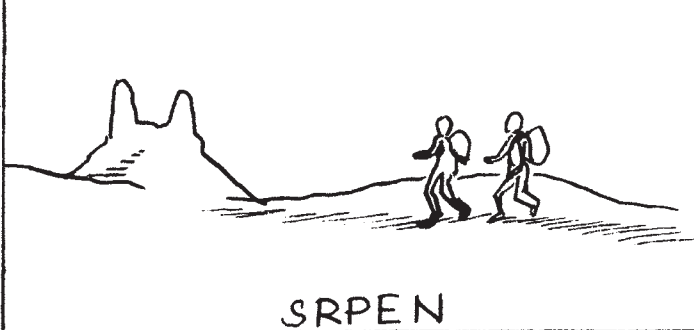

SRPEN

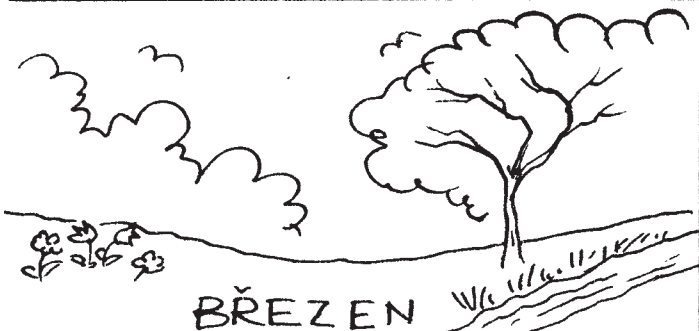

BŘEZEN

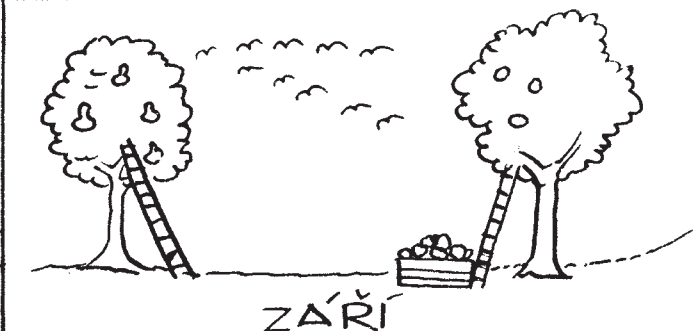

ZÁŘÍ

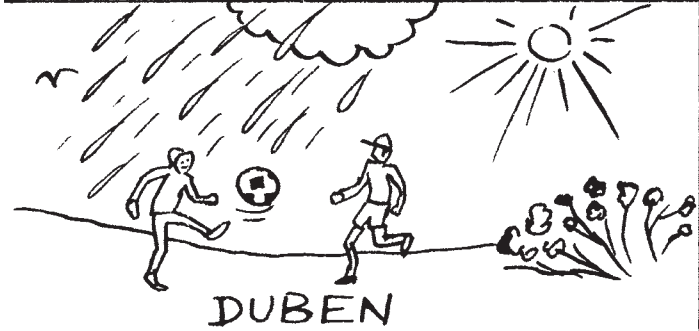

DUBEN



ŘÍJEN

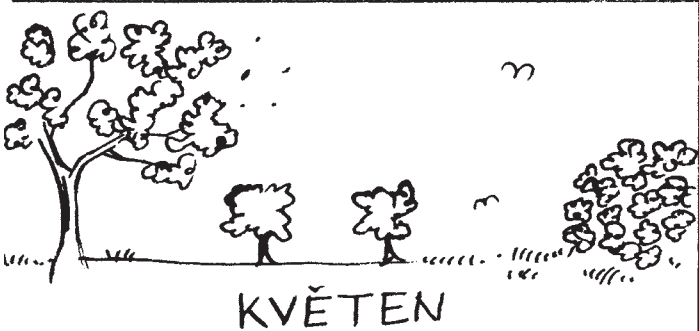

KVĚTEN



LISTOPAD

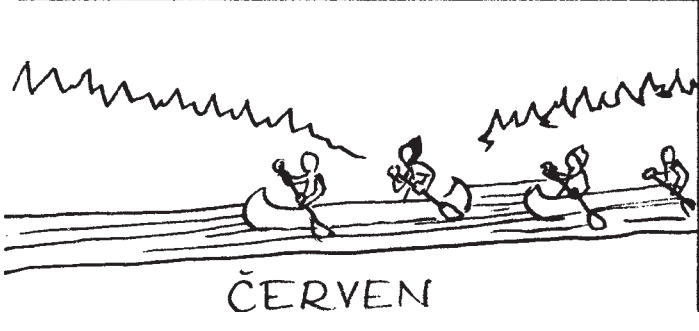

ČERVEN

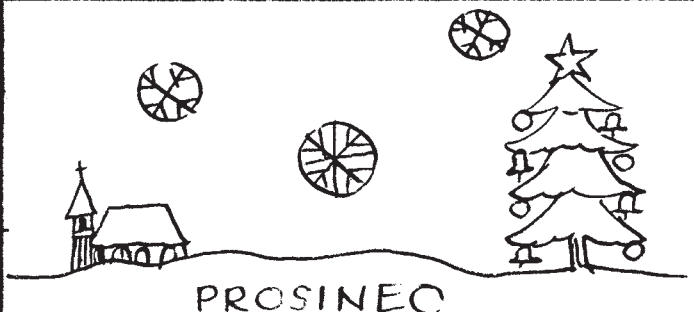

PROSINEC



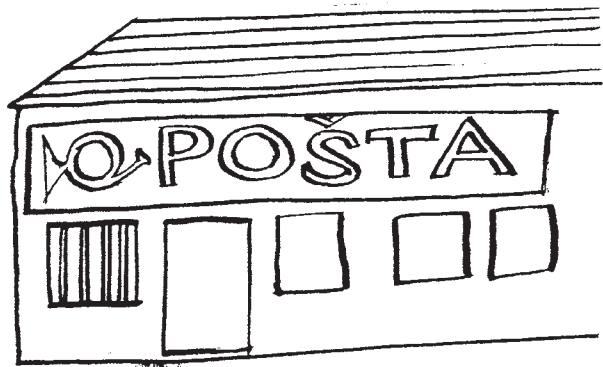
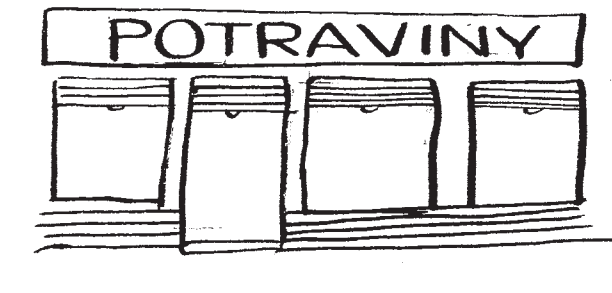
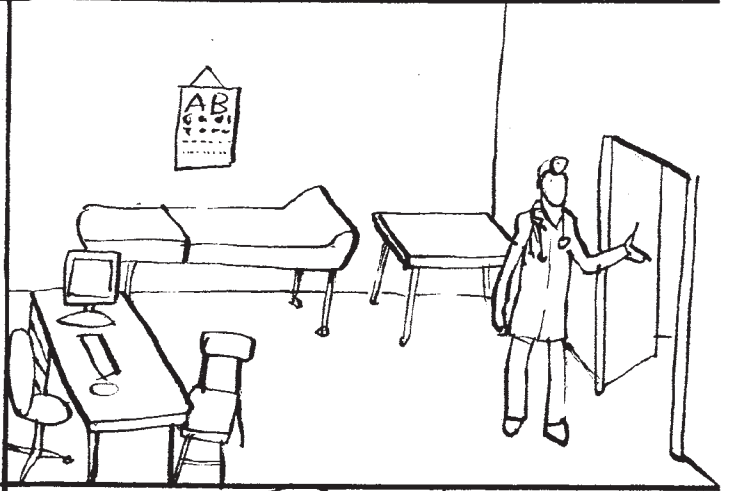
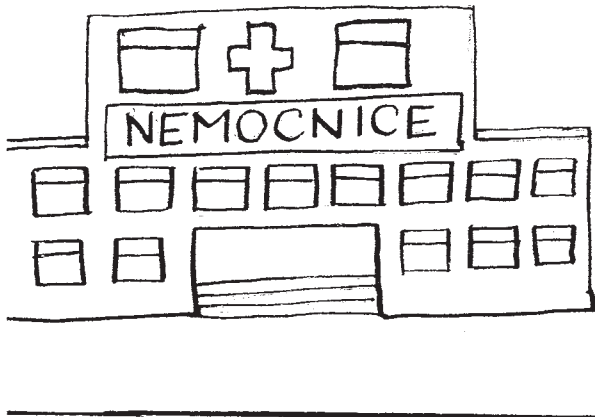

Narodil jsem se 10. 1. 1971 v Mostě. V roce 1977 jsem šel poprvé do školy. V Mostě jsem chodil do školy jenom jeden rok. Potom jsme se stěhovali do Kolína. V Kolíně jsem chodil na základní školu do roku 1985. Potom jsem studoval gymnázium od roku 1985 do roku 1989. V roce 1989 jsem dělal maturitu. Od roku 1990 do roku 1996 jsem studoval angličtinu a němčinu na Karlově univerzitě v Praze. Od roku 1997 pracuju jako učitel. Bydlím v Praze, jsem ženatý a mám dvě děti.

Narodil jsem se 10. 1. 1971 v Mostě. V roce 1977 jsem šel poprvé do školy. V Mostě jsem chodil do školy jenom jeden rok. Potom jsme se stěhovali do Kolína. V Kolíně jsem chodil na základní školu do roku 1985. Potom jsem studoval gymnázium od roku 1985 do roku 1989. V roce 1989 jsem dělal maturitu. Od roku 1990 do roku 1996 jsem studoval angličtinu a němčinu na Karlově univerzitě v Praze. Od roku 1997 pracuju jako učitel. Bydlím v Praze, jsem ženatý a mám dvě děti.

Narodil jsem se 10. 1. 1971 v Mostě. V roce 1977 jsem šel poprvé do školy. V Mostě jsem chodil do školy jenom jeden rok. Potom jsme se stěhovali do Kolína. V Kolíně jsem chodil na základní školu do roku 1985. Potom jsem studoval gymnázium od roku 1985 do roku 1989. V roce 1989 jsem dělal maturitu. Od roku 1990 do roku 1996 jsem studoval angličtinu a němčinu na Karlově univerzitě v Praze. Od roku 1997 pracuju jako učitel. Bydlím v Praze, jsem ženatý a mám dvě děti.

Narodil jsem se 10. 1. 1971 v Mostě. V roce 1977 jsem šel poprvé do školy. V Mostě jsem chodil do školy jenom jeden rok. Potom jsme se stěhovali do Kolína. V Kolíně jsem chodil na základní školu do roku 1985. Potom jsem studoval gymnázium od roku 1985 do roku 1989. V roce 1989 jsem dělal maturitu. Od roku 1990 do roku 1996 jsem studoval angličtinu a němčinu na Karlově univerzitě v Praze. Od roku 1997 pracuju jako učitel. Bydlím v Praze, jsem ženatý a mám dvě děti.

<b>kdo</b>	<b>nikdo</b>	Kdo mluví španělsky?	<b>NI -</b> <b>Nikdo</b> nemluví španělsky.
<b>jaký</b>	<b>žádný</b>	Jaký máte slovník?	<b>Nemám žádný</b> slovník.
<b>co</b>	<b>nic</b>	Co děláte večer?	<b>Nedělám nic.</b>
<b>kde</b>	<b>nikde</b>	Kde jste byla/la včera?	<b>Nebyl/la</b> jsem <b>nikde.</b>
<b>kam</b>	<b>nikam</b>	Kam jedete v sobotu?	<b>Nejedu nikam.</b>
<b>kdy</b>	<b>nikdy</b>	Kdy pijete alkohol?	<b>Nikdy nepiju</b> alkohol.

<b>kdo</b>	<b>někdo</b>	<b>NĚ-</b> Je tady <b>někdo</b> ?	<b>NI -</b> Ne, <b>nikdo</b> tady <b>není.</b>
<b>jaký</b>	<b>nějaký</b>	Máte <b>nějaký</b> slovník?	Ne, <b>nemám žádný</b> slovník.
<b>co</b>	<b>něco</b>	Víte už <b>něco</b> ?	Ne, <b>nevím nic.</b>
<b>kde</b>	<b>někde</b>	Je tady <b>někde</b> můj sešit?	Ne, <b>nikde</b> tady <b>není.</b>
<b>kam</b>	<b>někam</b>	Jedete <b>někam</b> v sobotu?	Ne, <b>nejedu nikam.</b>
<b>kdy</b>	<b>někdy</b>	Pijete <b>někdy</b> alkohol?	Ne, <b>nikdy nepiju</b> alkohol.

*Odpovídejte:*

*Máte nějaký časopis? Ne, nemáme žádný časopis.*

- Máte nějaký slovník? Ne,.....
- Víte už něco? Ne,.....
- Posloucháte někdy rock? Ne, .....
- Jedete někde v sobotu? Ne, .....
- Je tady někde můj slovník? Ne,.....
- Čtete nějakou knihu? Ne,.....
- Potřebujete něco? Ne,.....
- Jede Tomáš někde? Ne, .....
- Je tady někdo? Ne, .....
- Čekáte na někoho? Ne,.....



### 1. Převeďte věty do minulého času.

A.

1. Dnes snídám v 8 hodin.
2. Zítra jedeme do Prahy.
3. Čekáte na autobus?
4. Tento víkend nakupujeme v obchodním centru.
5. Pracuješ zítra?
6. Dnes ráno píšu dopis.
7. Potřebuješ ten slovník?
8. Co děláte dnes večer?
9. Tento pátek hraju tenis.
10. Dnes večer jsme doma, posloucháme hudbu a pijeme víno.

B.

1. Máš dnes volno?
2. Dnes večer jíme v restauraci.
3. Zítra jdu na koncert.
4. Chcete bydlet v České republice?
5. V neděli čtu knihu a dívám se na televizi.
6. Dnes nemáme čas.
7. Jíš čínské jídlo?
8. Chci studovat v Praze.
9. Dnes večer jdeme do kina.
10. Nečtu noviny, protože na to nemám čas.

C.

1. Kde pracuješ tento rok?
2. Monika hraje badminton.
3. Dnes si dám pizzu a pivo.
4. Pan Novák má zítra narozeniny.
5. Děti si hrajou venku.
6. Vstáváme v 7 hodin a snídáme v 7.30.
7. Dnes je čtvrtek.
8. Mluvíte s panem Horákem?
9. Karel a Jana přijdou zítra večer.
10. Paní Vránová potřebuje nový svetr.

Moje rodina.

Dobrý den. Jmenuju se Dana. Jsem učitelka češtiny. Tohle je moje rodina. Vepředu jsem já, můj bratr Petr a moje sestra Hana. Petr je programátor a Hana je doktorka. Já a sestra nejsme vdané, jsme svobodné. Bratr už je ženatý. Jeho žena Alice je prodavačka. Uprostřed je moje matka Alena a otec Pavel. Matka pracuje na úřadě a otec je právník. Matka má bratra. To je strýc Karel. On a jeho manželka – teta Lenka jsou vlevo. Strýc Karel je inženýr, teta Lenka pracuje na poště. Vpravo je teta Eva. Můj otec je její bratr. Teta Eva je ekonomka. Byla vdaná, ale teď je rozvedená. Vzadu vlevo jsou babička Zuzana a dědeček Martin. Moje matka a strýc Karel jsou jejich děti. Vzadu vpravo je babička Tereza. Babička je vdova - dědeček Václav už umřel.

Moje rodina.

Dobrý den. Jmenuju se Dana. Jsem učitelka češtiny. Tohle je moje rodina. Vepředu jsem já, můj bratr Petr a moje sestra Hana. Petr je programátor a Hana je doktorka. Já a sestra nejsme vdané, jsme svobodné. Bratr už je ženatý. Jeho žena Alice je prodavačka. Uprostřed je moje matka Alena a otec Pavel. Matka pracuje na úřadě a otec je právník. Matka má bratra. To je strýc Karel. On a jeho manželka – teta Lenka jsou vlevo. Strýc Karel je inženýr, teta Lenka pracuje na poště. Vpravo je teta Eva. Můj otec je její bratr. Teta Eva je ekonomka. Byla vdaná, ale teď je rozvedená. Vzadu vlevo jsou babička Zuzana a dědeček Martin. Moje matka a strýc Karel jsou jejich děti. Vzadu vpravo je babička Tereza. Babička je vdova - dědeček Václav už umřel.

Moje rodina.

Dobrý den. Jmenuju se Dana. Jsem učitelka češtiny. Tohle je moje rodina. Vepředu jsem já, můj bratr Petr a moje sestra Hana. Petr je programátor a Hana je doktorka. Já a sestra nejsme vdané, jsme svobodné. Bratr už je ženatý. Jeho žena Alice je prodavačka. Uprostřed je moje matka Alena a otec Pavel. Matka pracuje na úřadě a otec je právník. Matka má bratra. To je strýc Karel. On a jeho manželka – teta Lenka jsou vlevo. Strýc Karel je inženýr, teta Lenka pracuje na poště. Vpravo je teta Eva. Můj otec je její bratr. Teta Eva je ekonomka. Byla vdaná, ale teď je rozvedená. Vzadu vlevo jsou babička Zuzana a dědeček Martin. Moje matka a strýc Karel jsou jejich děti. Vzadu vpravo je babička Tereza. Babička je vdova - dědeček Václav už umřel.

Moje rodina.

Dobrý den. Jmenuju se Dana. Jsem učitelka češtiny. Tohle je moje rodina. Vepředu jsem já, můj bratr Petr a moje sestra Hana. Petr je programátor a Hana je doktorka. Já a sestra nejsme vdané, jsme svobodné. Bratr už je ženatý. Jeho žena Alice je prodavačka. Uprostřed je moje matka Alena a otec Pavel. Matka pracuje na úřadě a otec je právník. Matka má bratra. To je strýc Karel. On a jeho manželka – teta Lenka jsou vlevo. Strýc Karel je inženýr, teta Lenka pracuje na poště. Vpravo je teta Eva. Můj otec je její bratr. Teta Eva je ekonomka. Byla vdaná, ale teď je rozvedená. Vzadu vlevo jsou babička Zuzana a dědeček Martin. Moje matka a strýc Karel jsou jejich děti. Vzadu vpravo je babička Tereza. Babička je vdova - dědeček Václav už umřel.

KDO	JMÉNO	ZAMĚŠTNÁNÍ	RODINNÝ STAV	DĚTI (ano – ne)
já				
↳ jeho manželka		programátor		
	Hana		vdaná	
		na úřadě		
otec			ženatý	
	Lenka			
strýc				
		ekonomka		
	Zuzana			
dědeček				
	Tereza			

KDO	JMÉNO	ZAMĚŠTNÁNÍ	RODINNÝ STAV	DĚTI (ano – ne)
já				
↳ jeho manželka		programátor		
	Hana		vdaná	
		na úřadě		
otec			ženatý	
	Lenka			
strýc				
		ekonomka		
	Zuzana			
dědeček				
	Tereza			

KDO	JMÉNO	ZAMĚŠTNÁNÍ	RODINNÝ STAV	DĚTI (ano – ne)
já				
↳ jeho manželka		programátor		
	Hana		vdaná	
		na úřadě		
otec			ženatý	
	Lenka			
strýc				
		ekonomka		
	Zuzana			
dědeček				
	Tereza			



### 1. Doplňte komparativ:

Zelený čaj je dobrý, ale černý čaj je .....  
Mám velký dům, ale můj bratr má ..... dům.  
V Praze je špatné počasí, ale v Liberci je .....  
Máš malý telefon, ale já mám .....  
Šel jsem domů brzo, ale Jana šla domů .....  
Mám hodně peněz, ale vy máte .....  
Přišli jsme pozdě, ale oni přišli .....

### 2. Doplňte superlativ.

Rusko je ..... stát na světě.  
Čína má ..... lidí na světě.  
Vatikán je ..... stát na světě.  
Česká republika má ..... pivo na světě.  
Musíme tam přijít ..... v 8 hodin. (pozdě)  
Včera jsem měl ..... den v životě. (špatný)  
Můžu přijet ..... v 6 hodin. (brzo)

### 3. Doplňte komparativ nebo superlativ

Ted' mám (velký) ..... auto než (brzo) .....  
Příští rok chci mít (hodně) ..... volného času než tento rok.  
Wang je (dobrý) ..... student než Ahmed, ale Alexej je (dobrý)  
..... student ze všech.  
Praha je (velký) ..... město v České republice.  
Brno je (malý) ..... než Praha, ale je to (velké) ..... město na  
Moravě.  
Ted' piju (hodně) ..... kávy než (brzo) .....  
Sandra je moje (dobrý) ..... kamarádka.  
Ten film je (špatný) ..... než ten, který jsme viděli včera.

### 4. Doplňte komparativ nebo superlativ

Jana je (hezký) ..... než Monika.  
Monika má (krátký) ..... vlasy než Tereza, ale Veronika má (krátký)  
..... vlasy ze všech.  
Řeka Labe je (dlouhý) ..... než řeka Vltava, je to (dlouhý) .....  
řeka v České republice.  
Jablko je (levný) ..... než pomeranč.  
Tvůj počítač je (drahý) ..... než můj.

### 5. Porovnejte následující dvojice.

Česká republika – Rusko, víno – pivo, Čína – Slovensko, babička – vnučka, tramvaj – auto,  
hovězí maso – kuřecí maso, čaj – káva, měsíc – týden



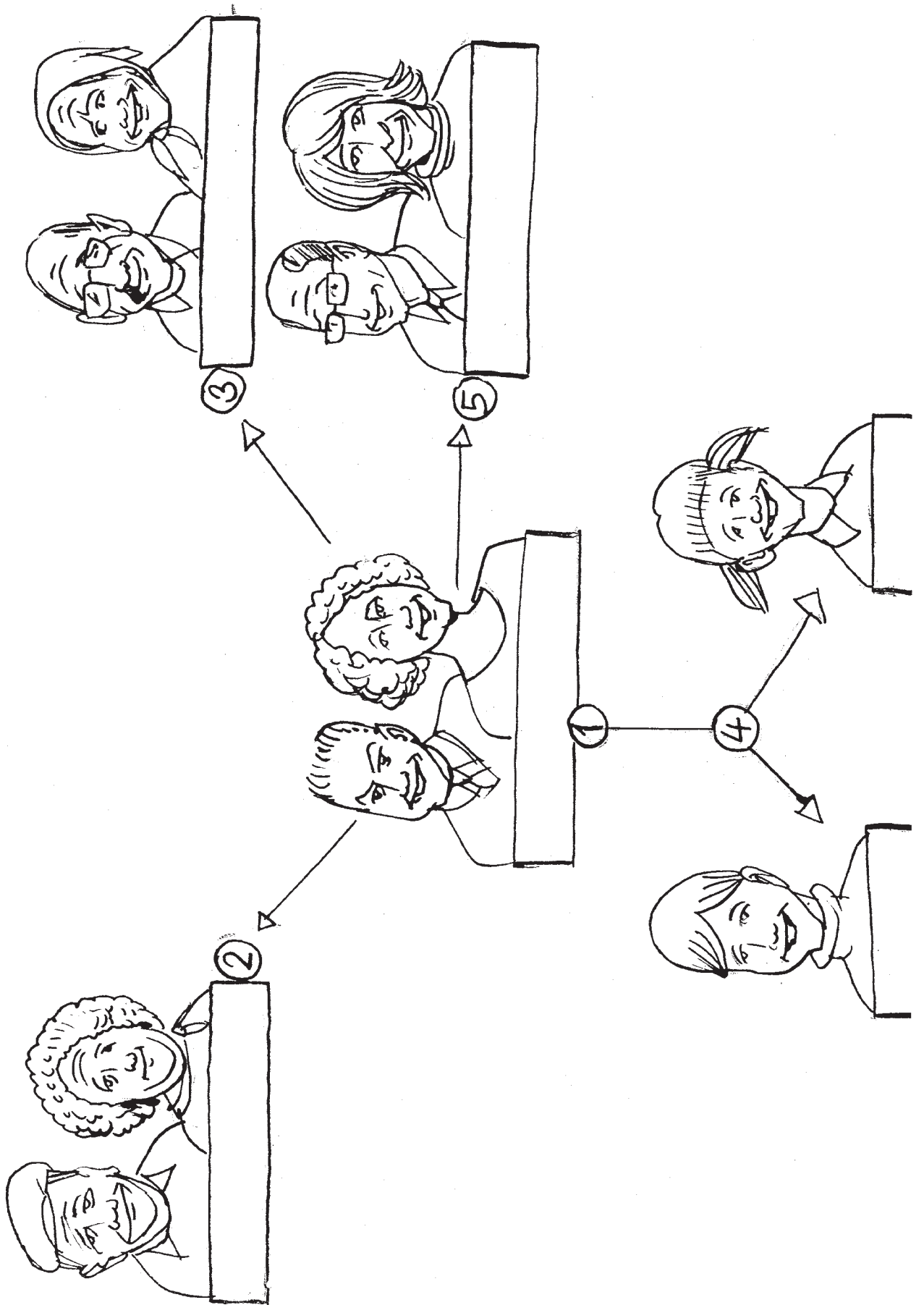

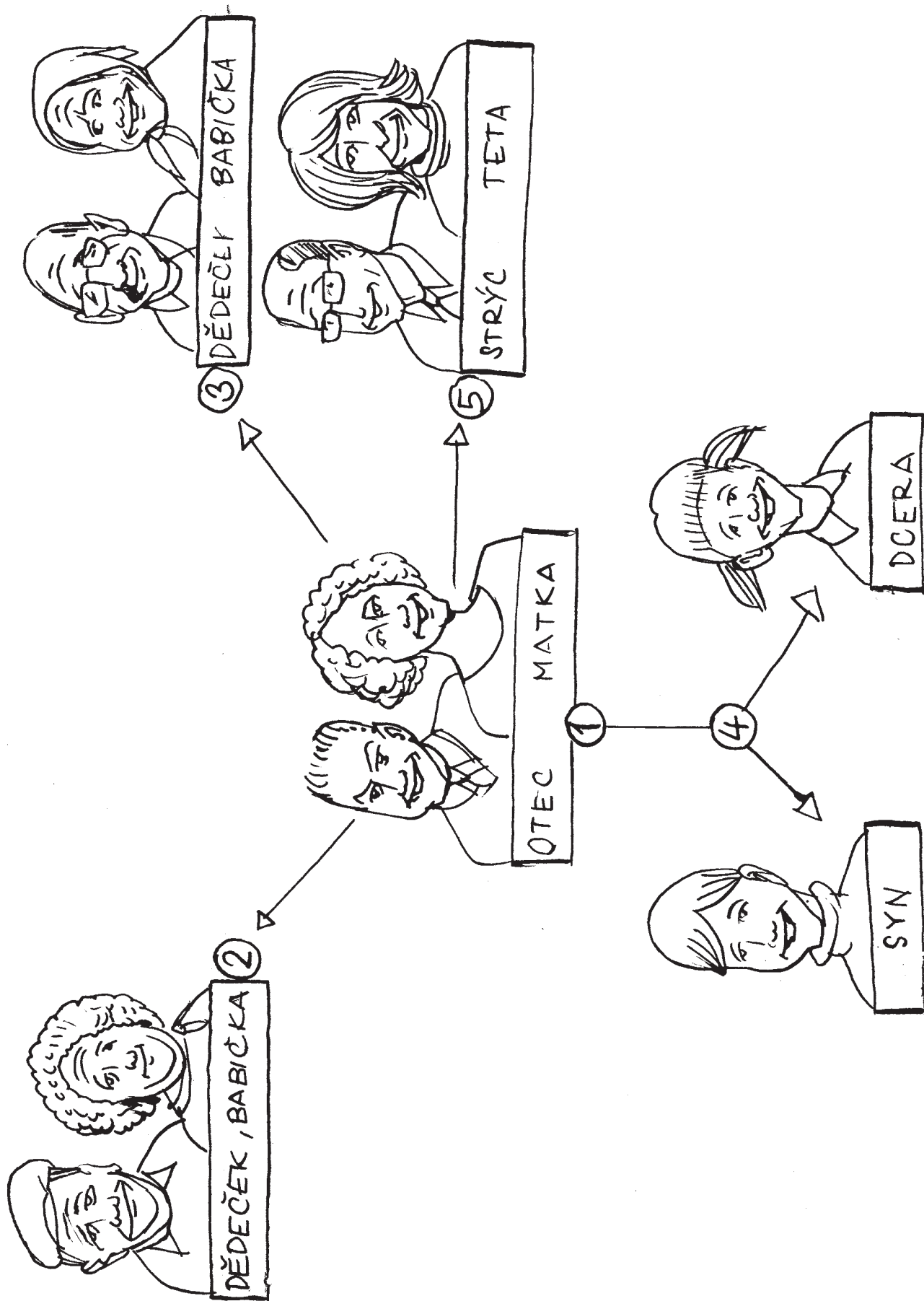

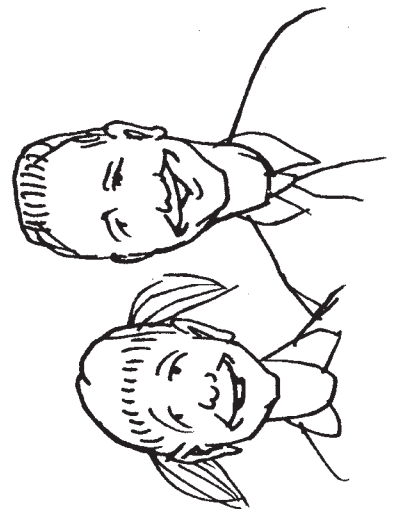

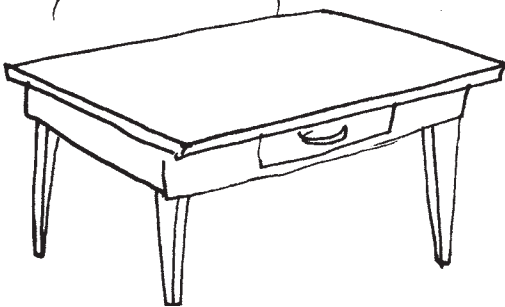
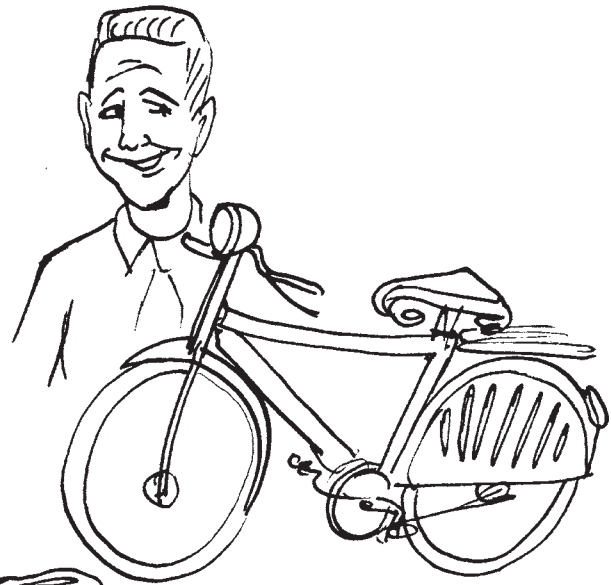
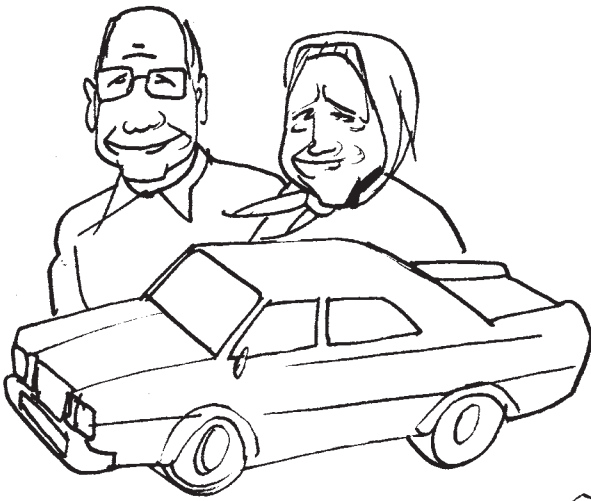

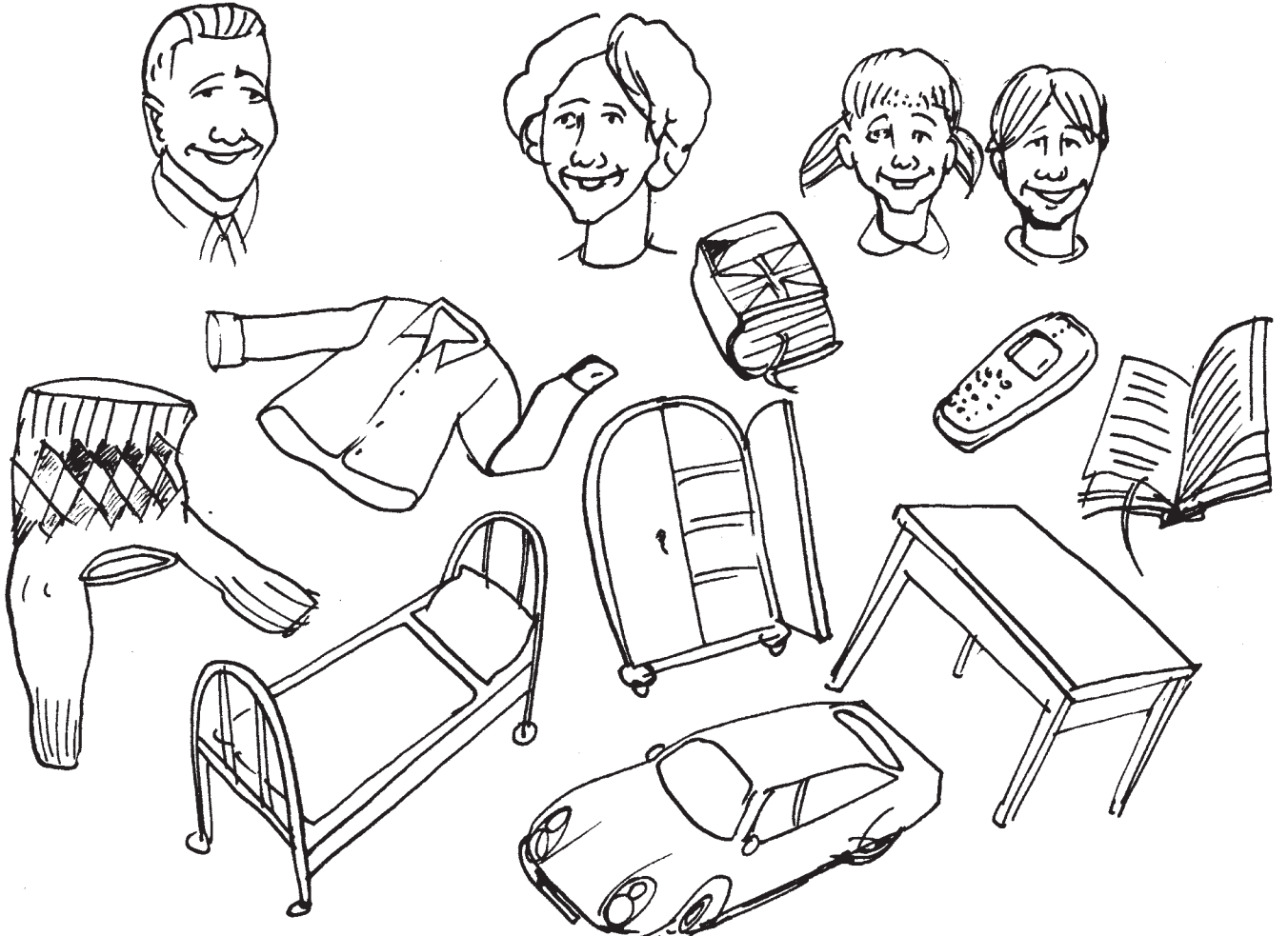
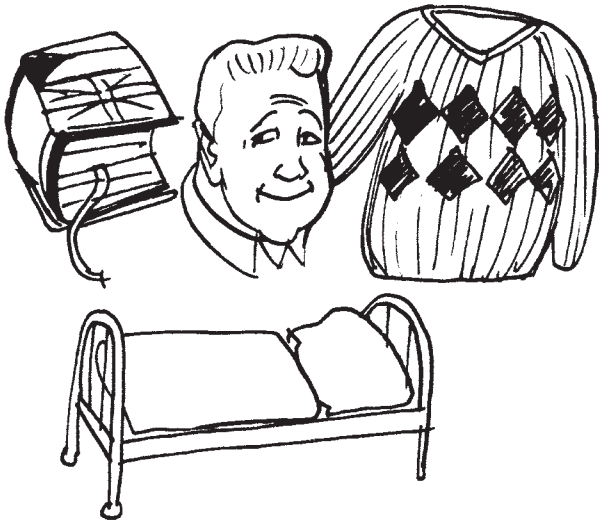



SVOBODNÝ / SVOBODNÁ



ŽENATÝ / VDANÁ



VDOVEC / VDOVA

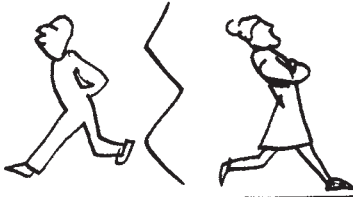

ROZVEDENÝ / ROZVEDENÁ

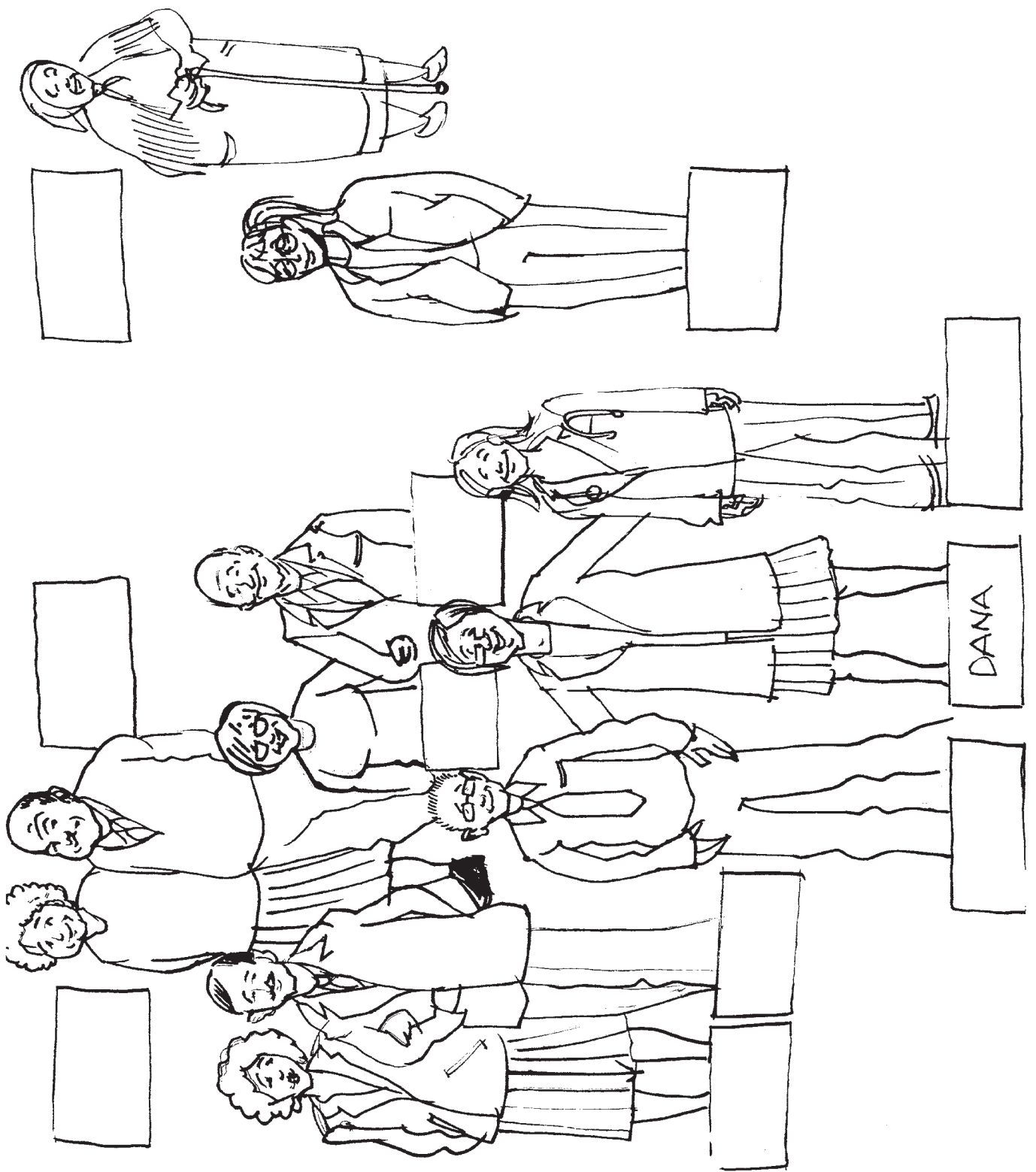

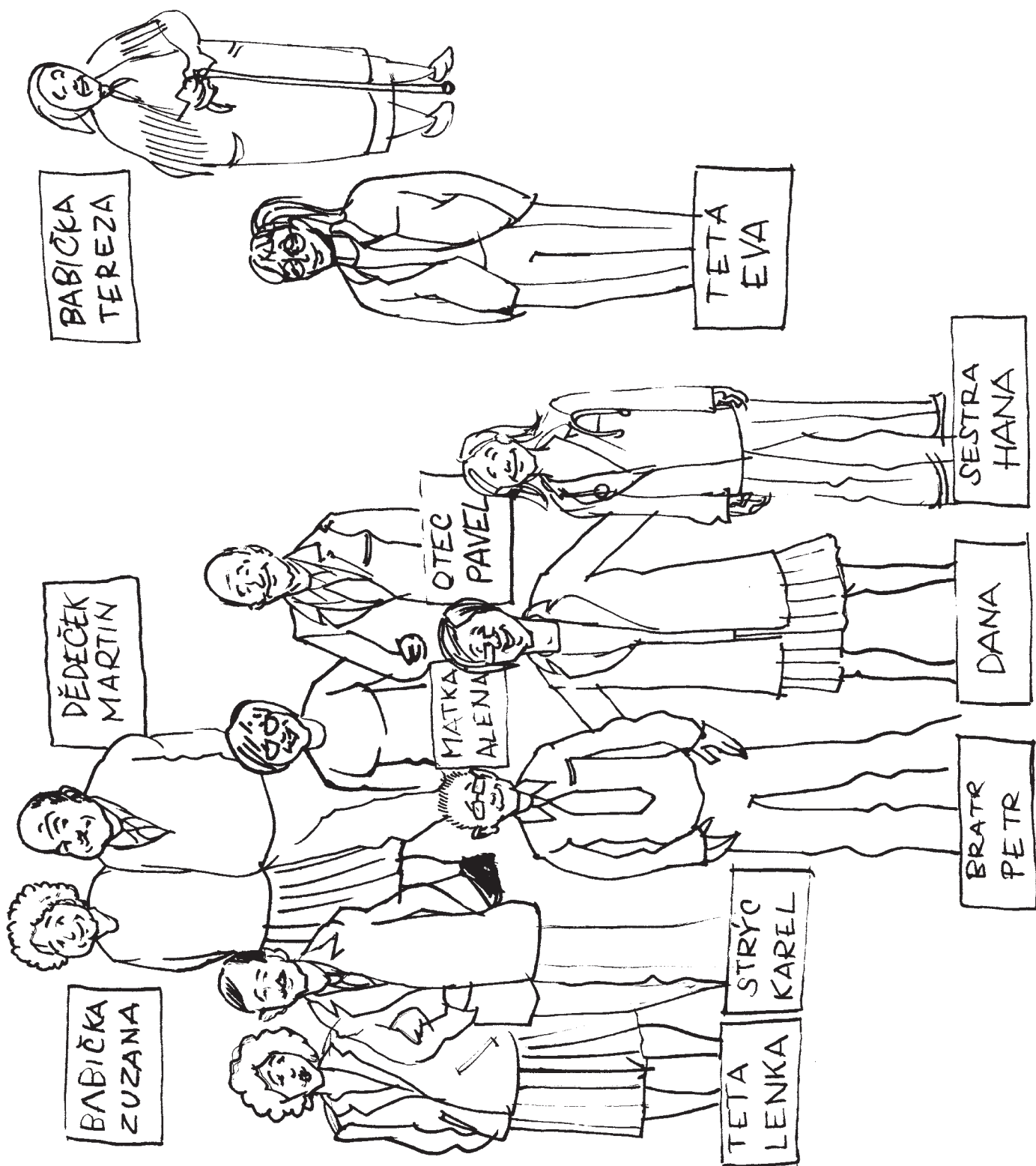



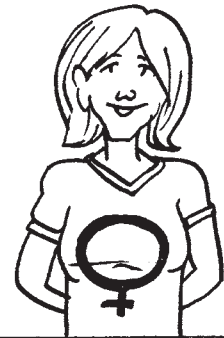

MA'M RA'D  
BANA'NY

MA'M RA'DA  
BANA'NY



MA'M RA'D  
ZMRZLINU

MA'M RA'DA  
ZMRZLINU

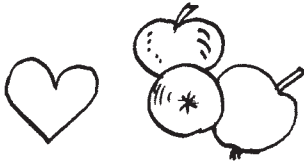

MA'M RA'D  
JABLKA

MA'M RA'DA  
JABLKA

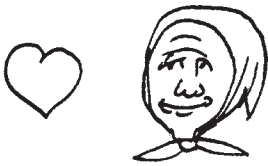

MA'M RA'D  
BABIČKU

MA'M RA'DA  
BABIČKU

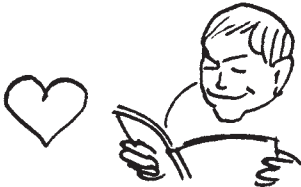

RA'D ČTU

RA'DA ČTU

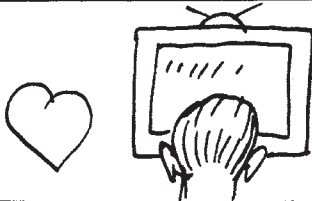

RA'D SE DÍVA'M  
NA TELEVIZI

RA'DA SE DÍVA'M  
NA TELEVIZI



RA'D VAŘÍM

RA'DA VAŘÍM



RA'D HRAJU  
FOTBAL

RA'DA HRAJU  
FOTBAL

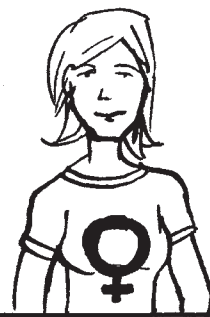

MA'M RA'D  
ZELENINU

MA'M RA'DA  
ZELENINU



MA'M RA'D  
CIGARETY

MA'M RA'DA  
CIGARETY

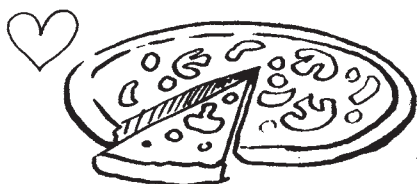

RA'D JIM  
PIZZU

RA'DA JIM  
PIZZU

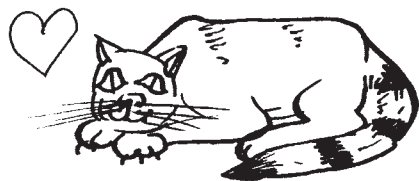

MA'M RA'D  
KOČKU

MA'M RA'DA  
KOČKU

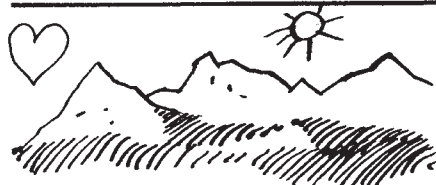

RA'D JEZDIM  
NA HORY

RA'DA JEZDIM  
NA HORY



MA'M RA'D  
KVĚTINY

MA'M RA'DA  
KVĚTINY



RA'D PIJI  
MLEKO

RA'DA PIJI  
MLEKO



MA'M RA'D  
PSA

MA'M RA'DA  
PSA



NEMA'M RA'D  
BANA'NY

NEMA'M RA'DA  
BANA'NY



NEMA'M RA'D  
ZMRZLINU

NEMA'M RA'DA  
ZMRZLINU

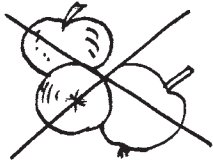

NEMA'M RA'D  
JABLKA

NEMA'M RA'DA  
JABLKA



NEMA'M RA'D  
BABIČKU

NEMA'M RA'DA  
BABIČKU



NERAD ČTU

NERADA ČTU

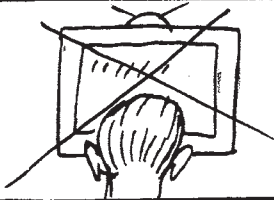

NERAD SE DÍVA'M  
NA TELEVIZI

NERADA SE DÍVA'M  
NA TELEVIZI



NERAD VAŘÍM

NERADA VAŘÍM



NERAD HRAJU  
FOTBAL

NERADA HRAJU  
FOTBAL



NEMÁM RA'D  
ZELENINU

NEMÁM RA'DA  
ZELENINU

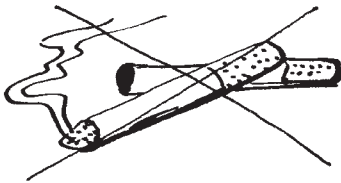

NEMÁM RA'D  
CIGARETY

NEMÁM RA'DA  
CIGARETY

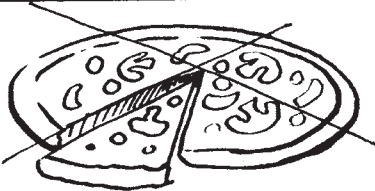

NERAD JÍM  
PIZZU

NERADA JÍM  
PIZZU

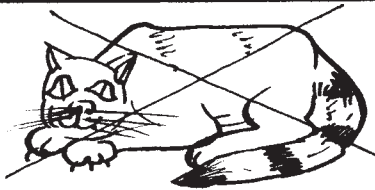

NEMÁM RA'D  
KOČKU

NEMÁM RA'DA  
KOČKU

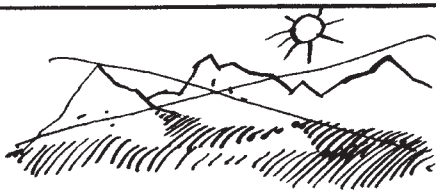

NERAD JEZDÍM  
NA HORY

NERADA JEZDÍM  
NA HORY

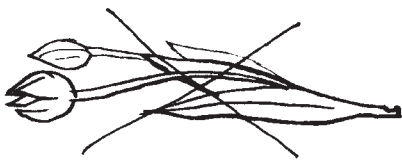

NEMÁM RA'D  
KVĚTINY

NEMÁM RA'DA  
KVĚTINY



NERAD PIJI  
MLEKO

NERADA PIJI  
MLEKO

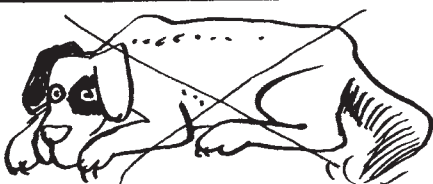

NEMÁM RA'D  
PSA

NEMÁM RA'DA  
PSA

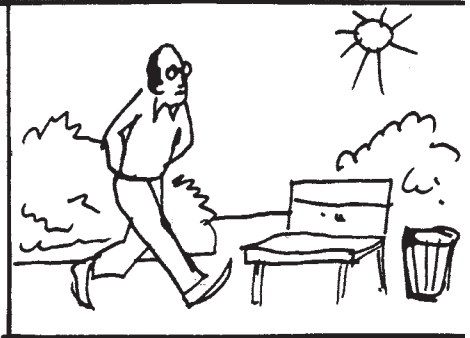
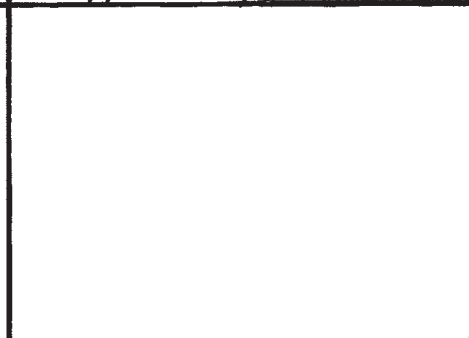
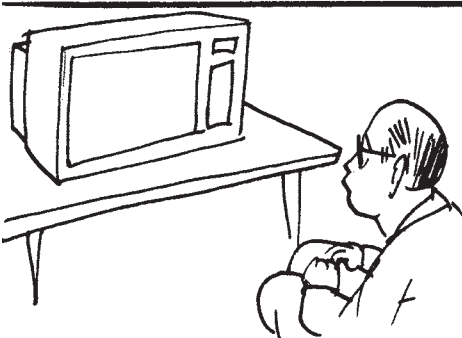
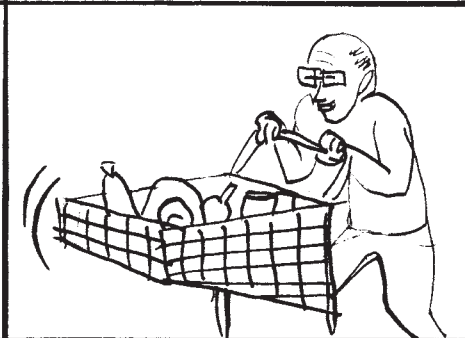
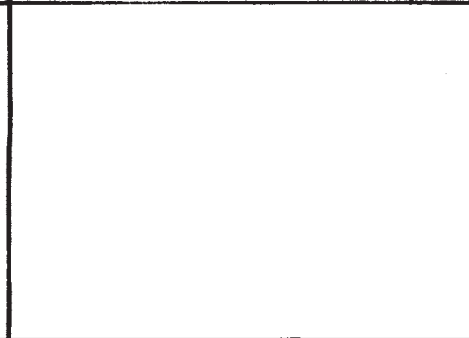
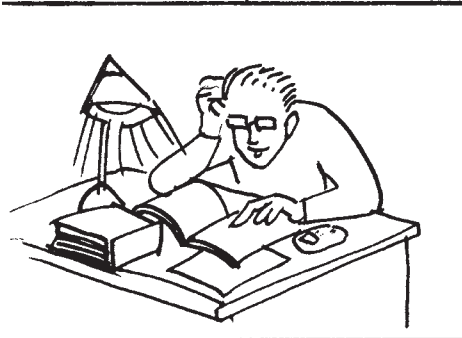





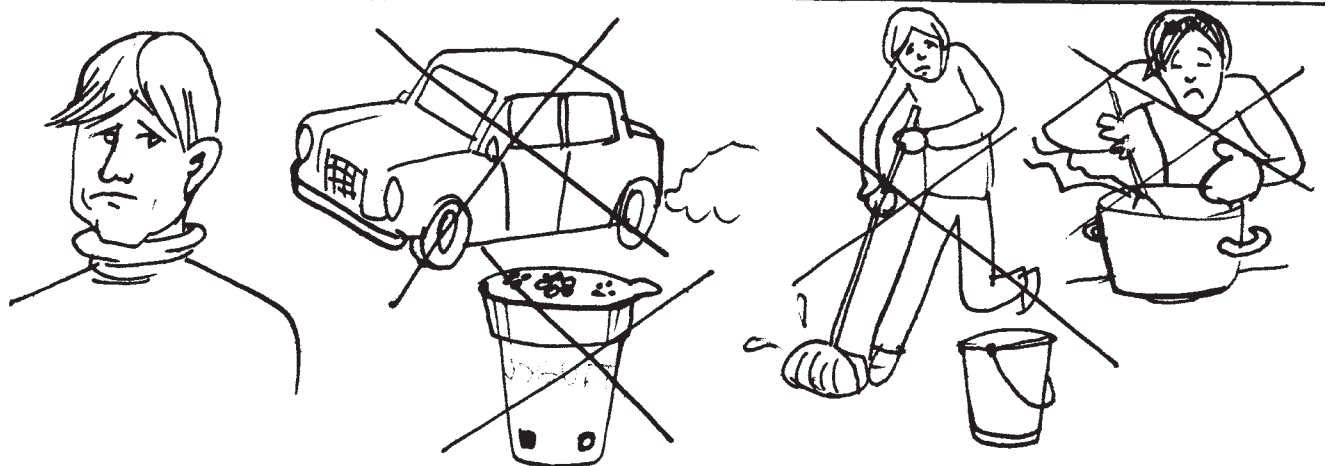
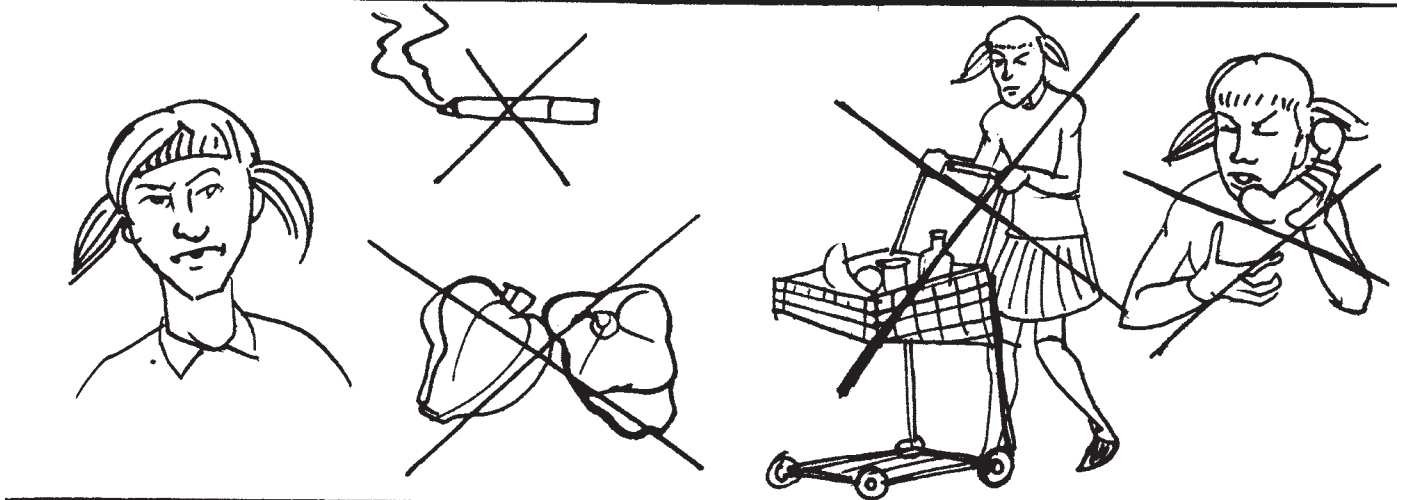
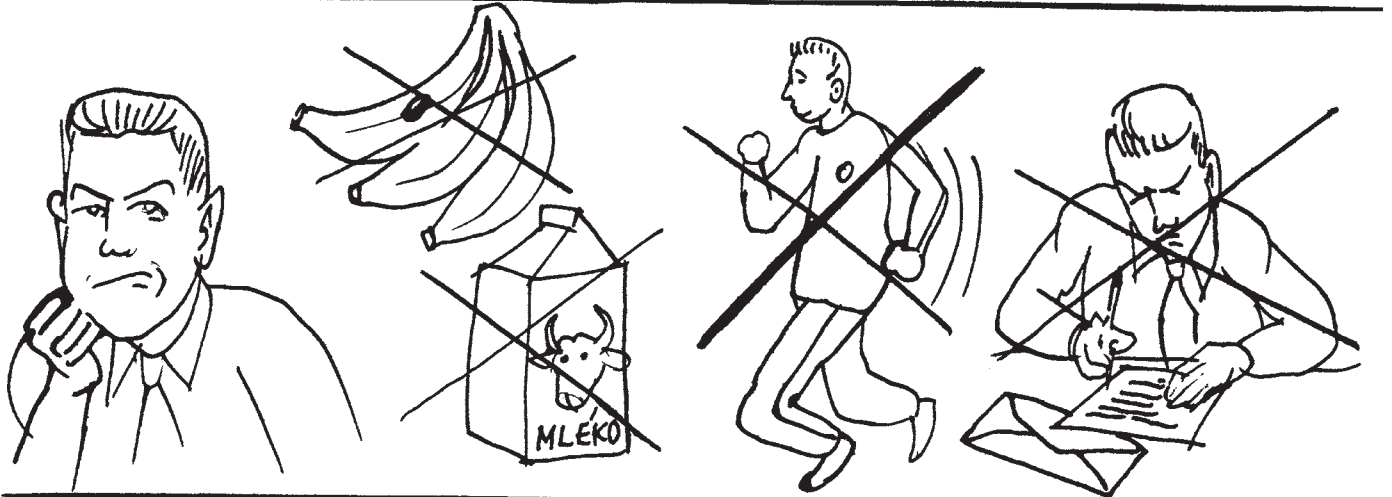
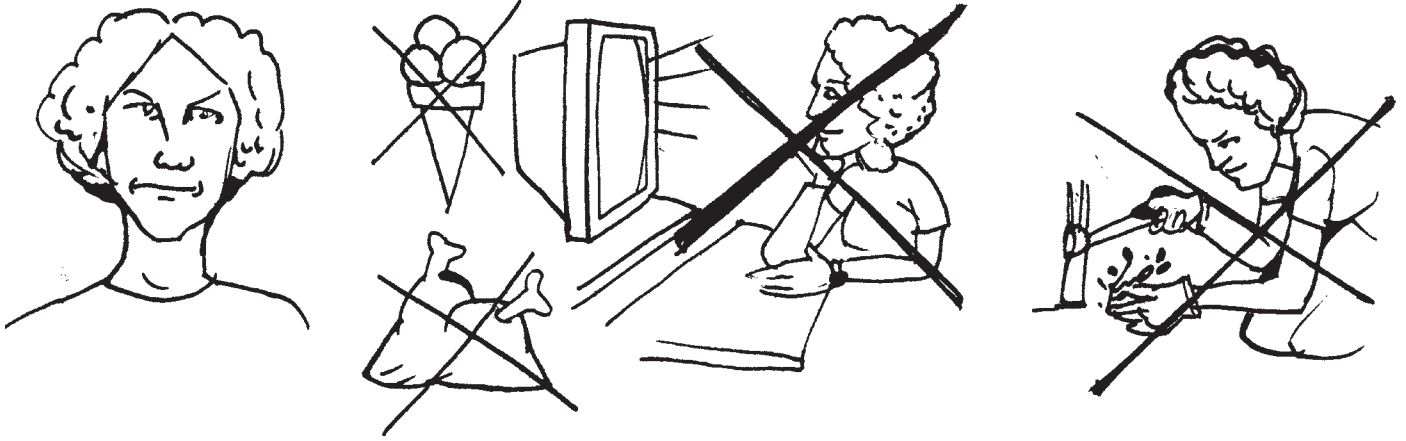

2351

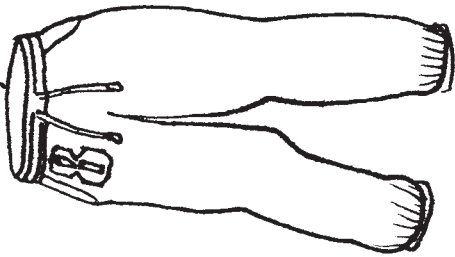

1501

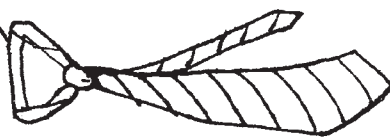

9801



7901

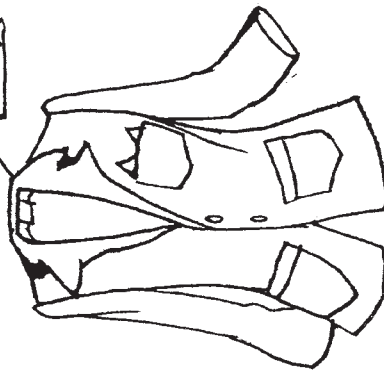

7301

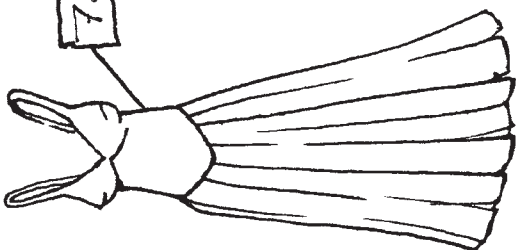

4201



9951

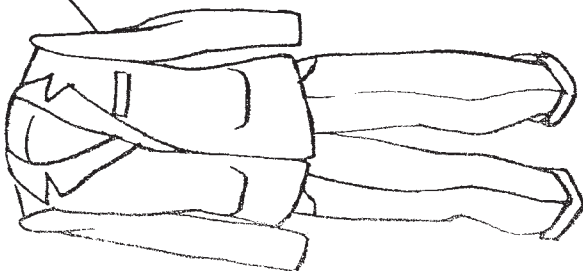

6501

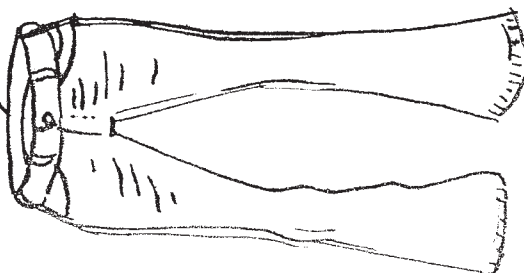



385

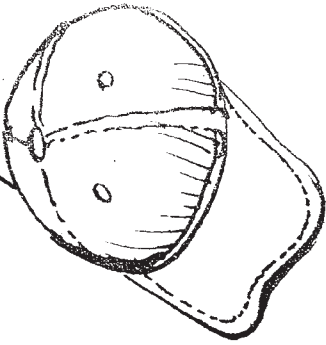

229

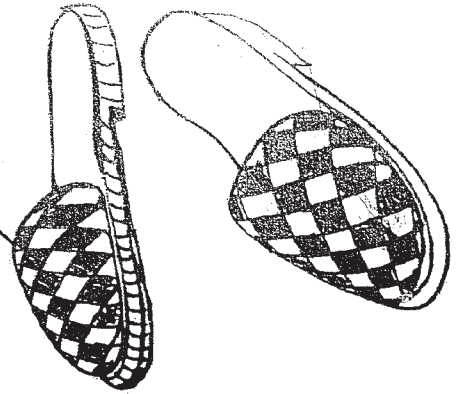

900

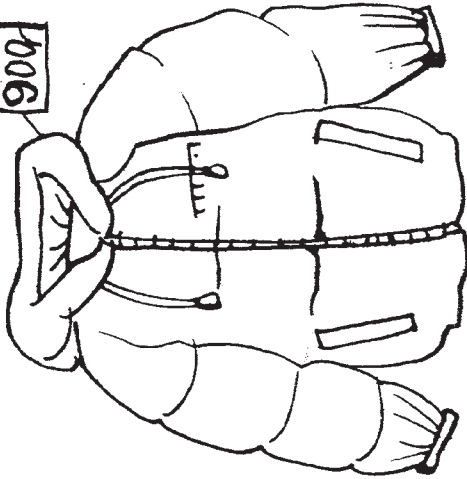

800

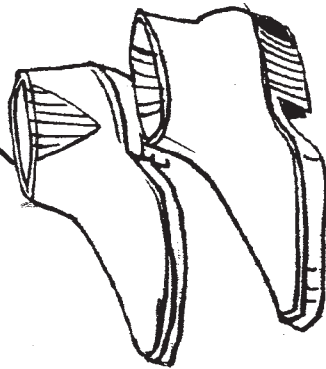

450

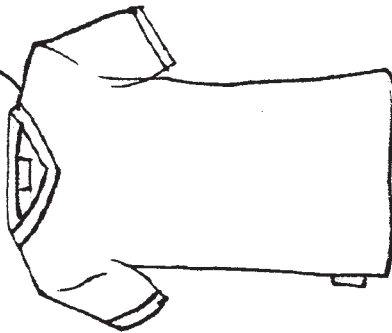

500

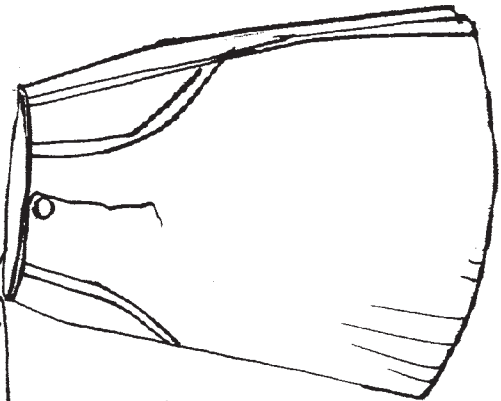

720

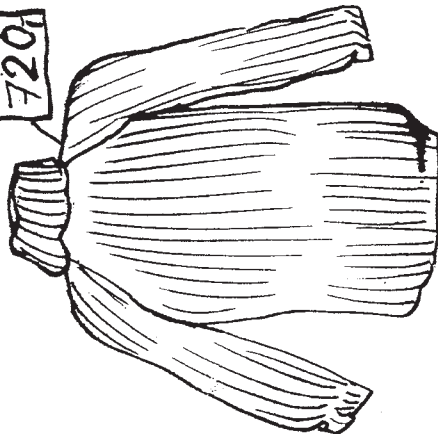

675

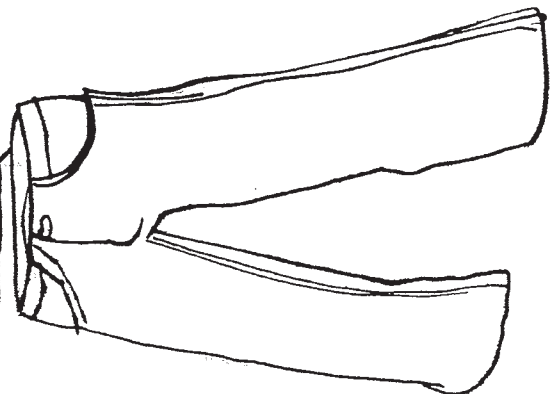

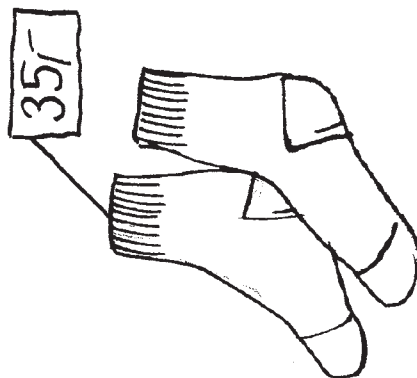
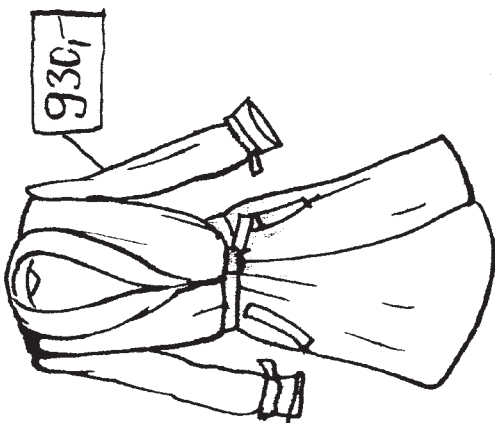
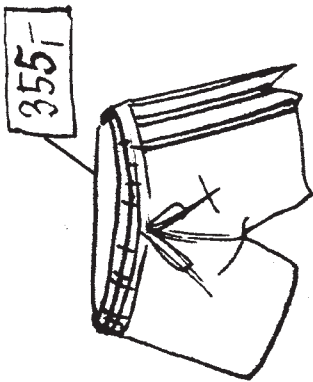
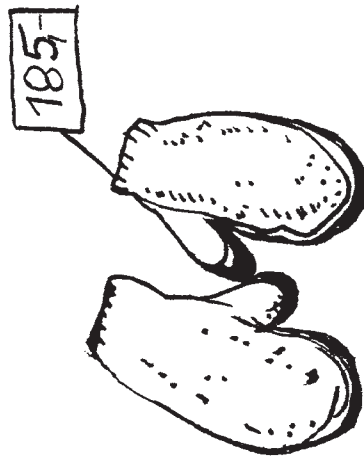
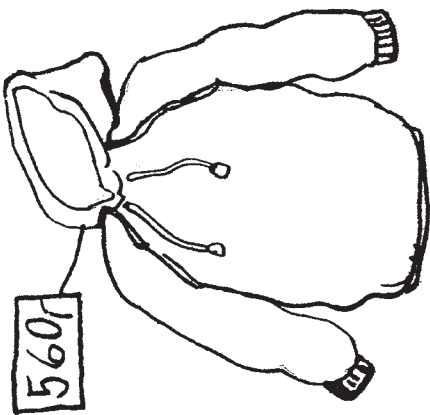

STUDENT

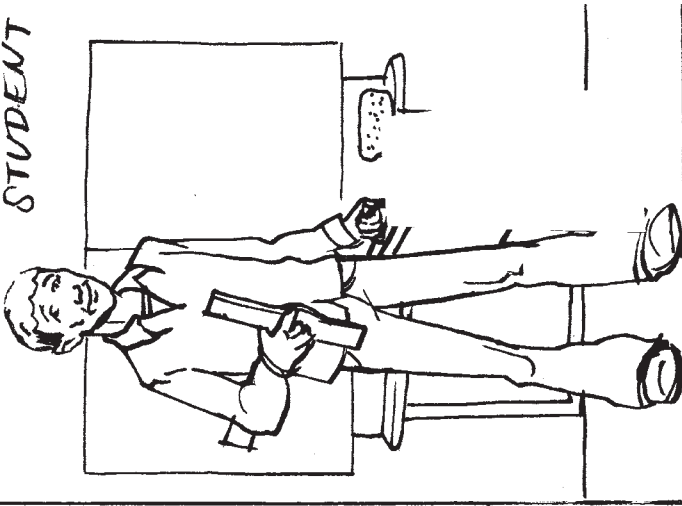

PETR



ČIŠŤNÍK

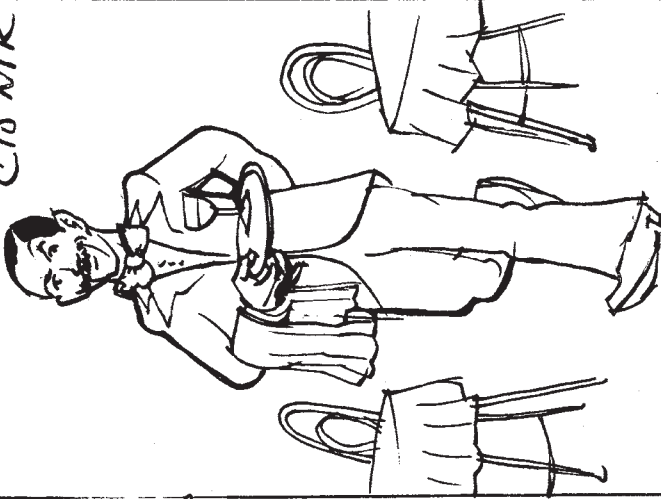

JANA

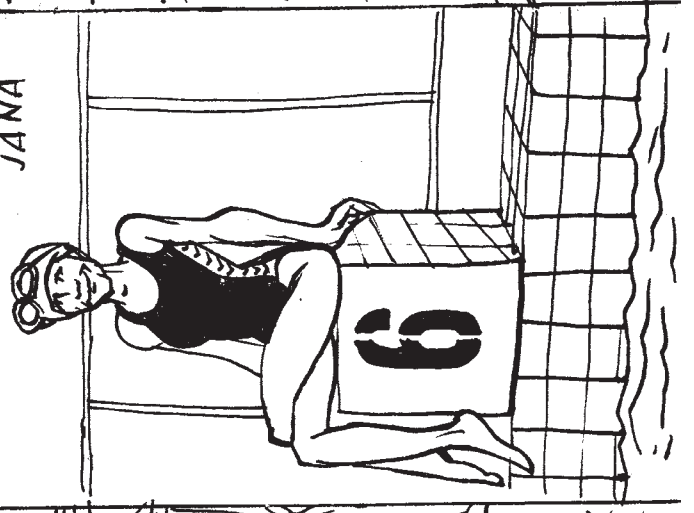

HONZA

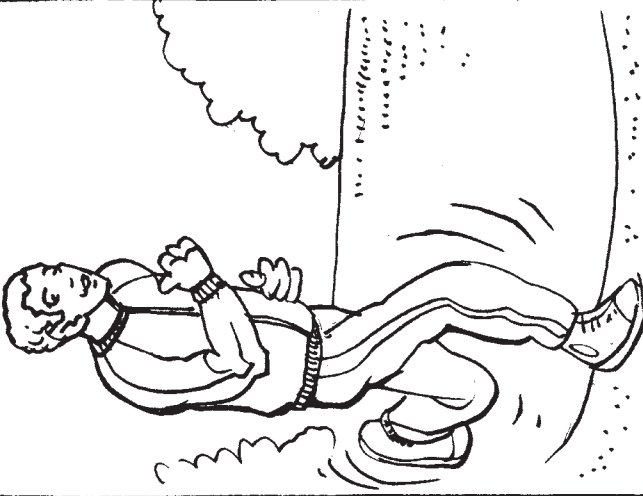

PANI NOVOTNÁ



PAN NOVAČEK

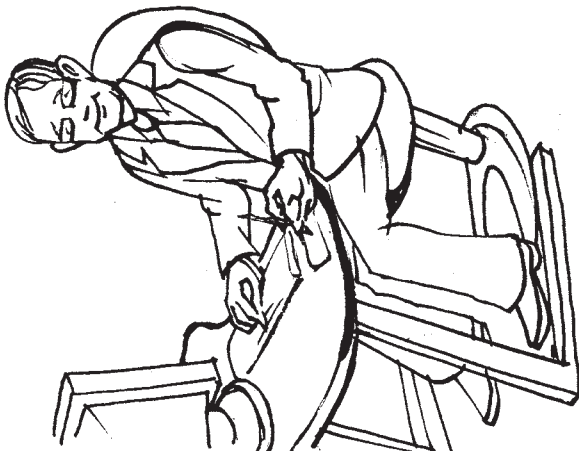

PANI HAVLÍKOVÁ

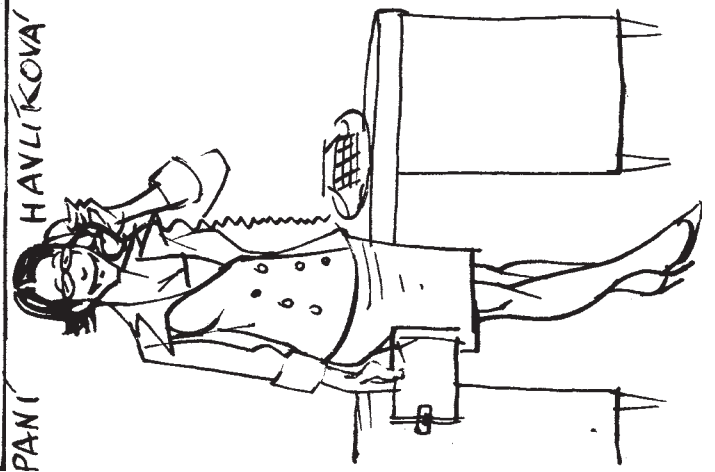



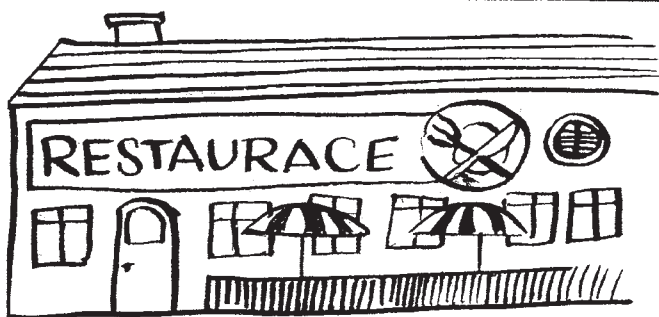
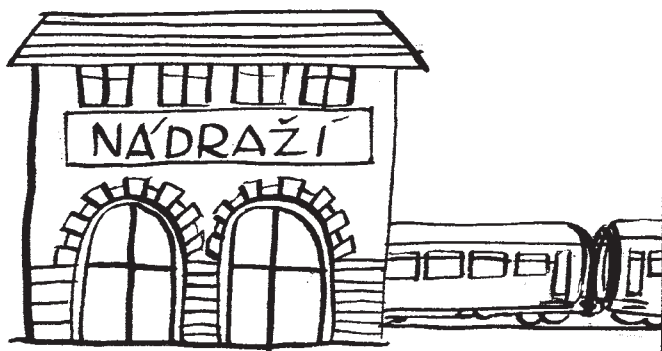
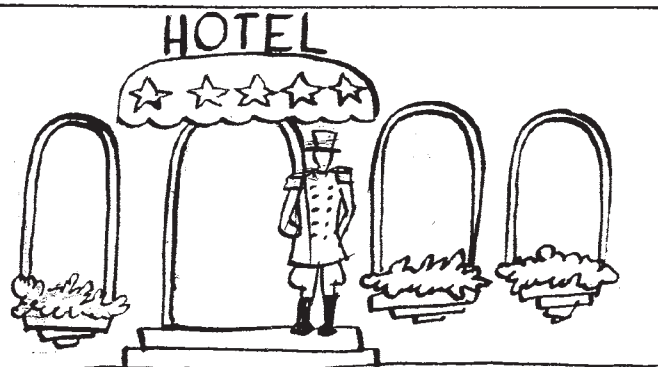
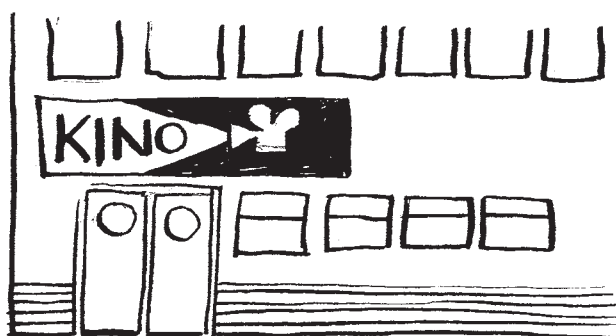
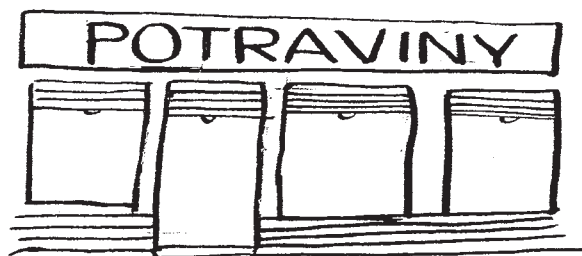
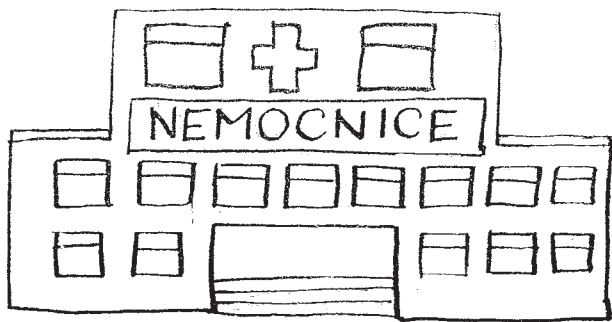

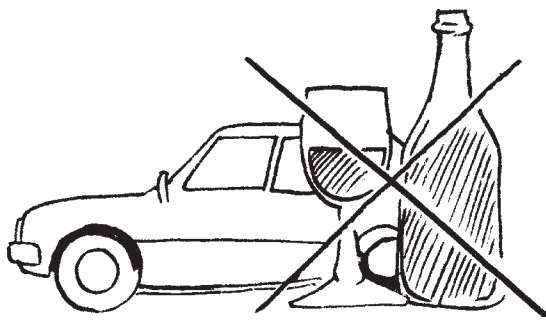

TADY NESMÍTE  
TELEFONOVAT.

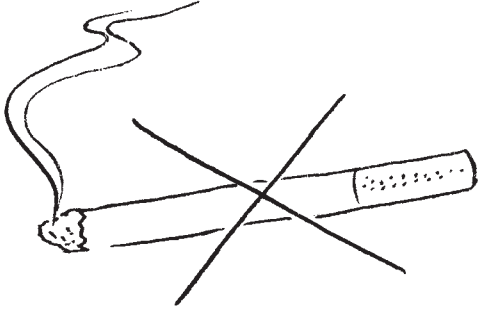

TADY NESMÍTE  
JET AUTEM.

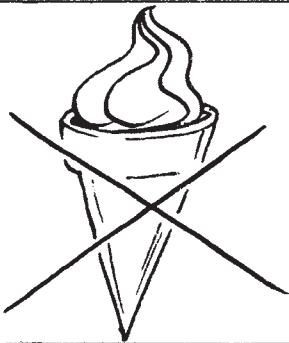

TADY NESMÍTE  
KOUŘIT.

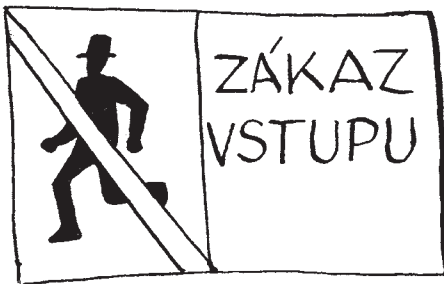

TADY NESMÍTE  
JÍST ZMRZLINU

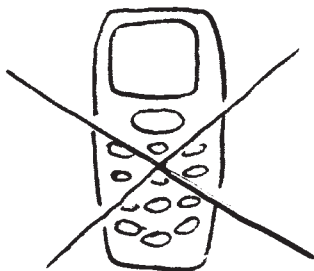

TAM NESMÍTE  
JÍT

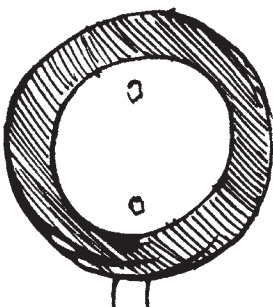

KDYŽ ŘÍDÍTE AUTO,  
NESMÍTE PÍT ALKOHOL.



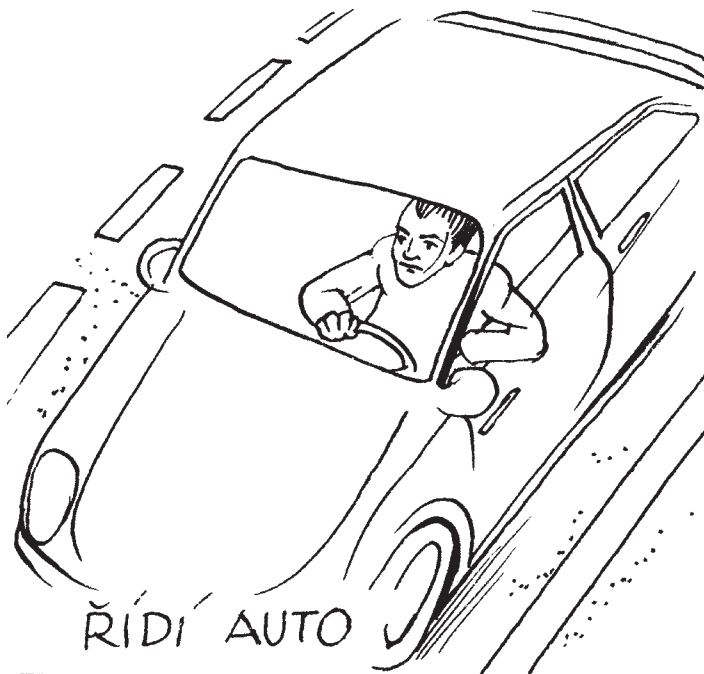

ŘÍDÍ AUTO

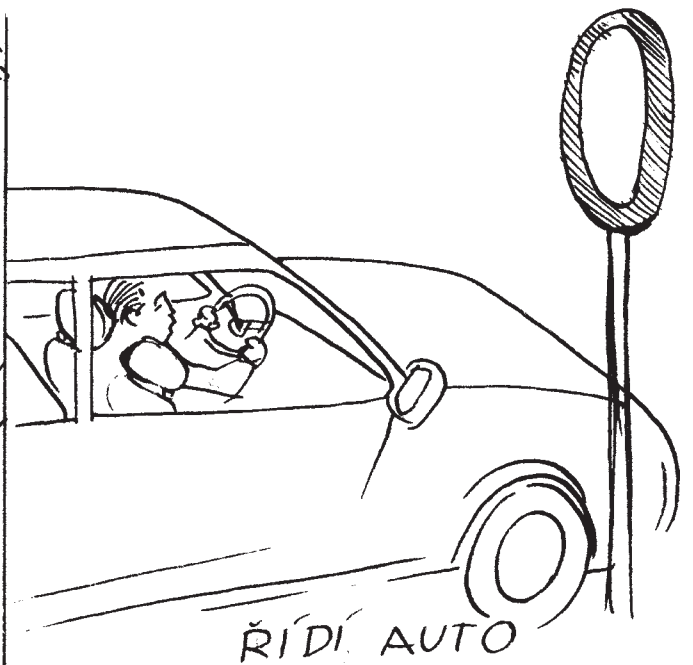

ŘÍDÍ AUTO

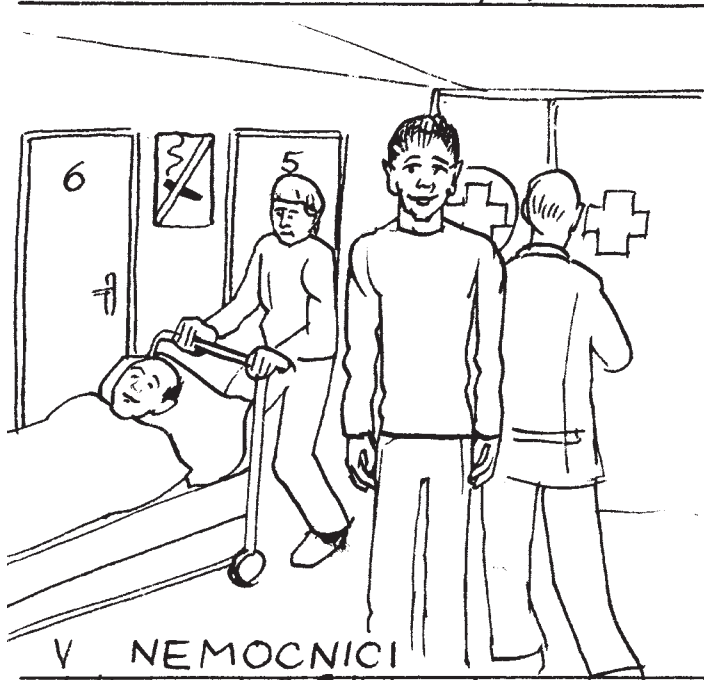

V NEMOCNICI

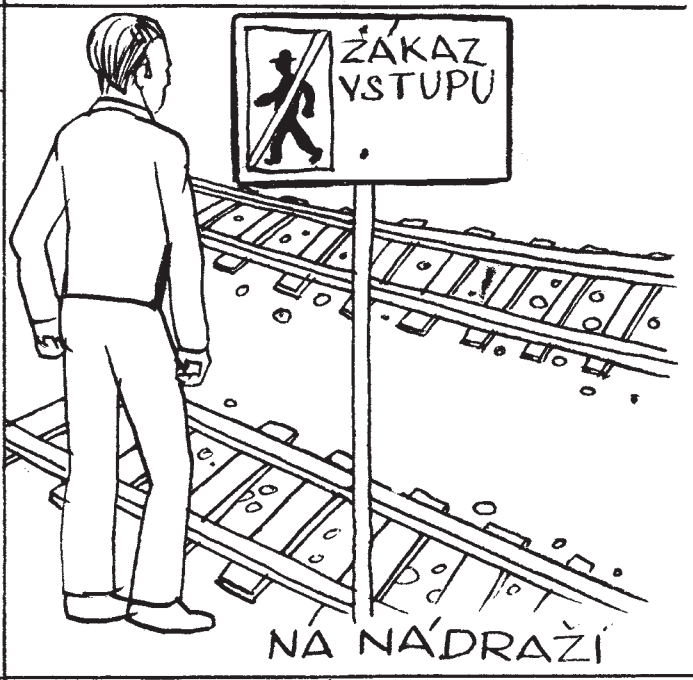

NA NÁDRAŽÍ



V OBCHODĚ

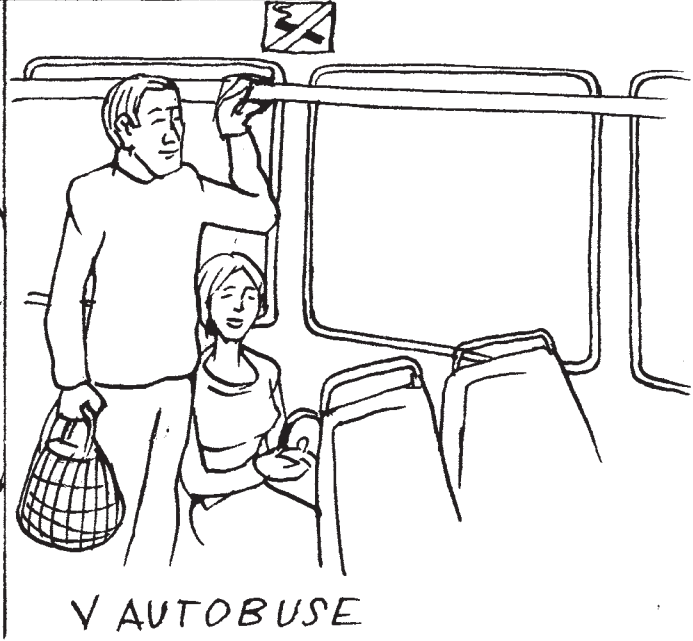

V AUTOBUSE



KDYŽ JE ČERVENÁ,  
MUSÍTE STAŤ.

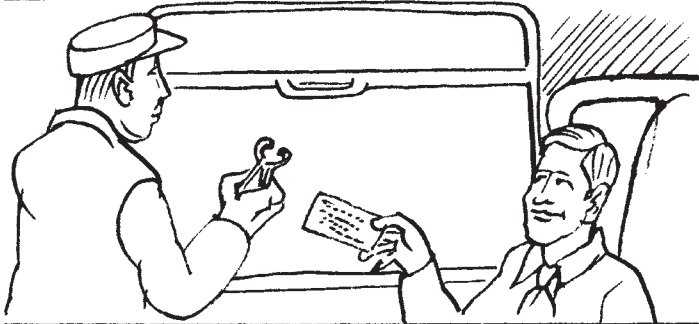

MUSÍTE VYPLNIT  
TEN FORMULÁŘ.

3	7
ÚNOR	8 ✓ PRÁCE
PO	9
	10

KDYŽ JSTE NEMOCNÝ,  
MUSÍTE BÝT V POSTELI



V OBCHODĚ MUSÍTE  
PLATIT.

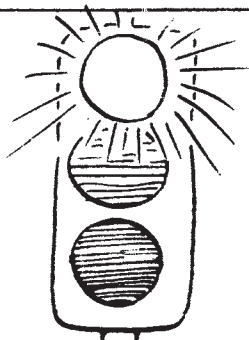

V PONDĚLÍ MUSÍTE  
BÝT V 8 HODIN V PRÁCI.

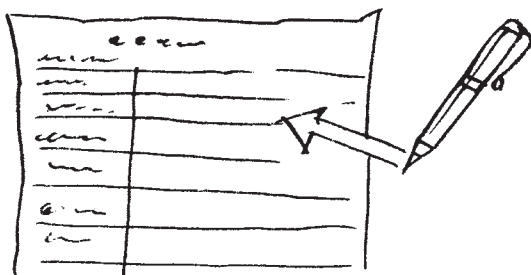

VE VLAKU MUSÍTE  
MÍT JÍZDENKU.





V INTERNETOVÉ KAVÁRNĚ

TADY MŮŽETE  
PÍT.



V JÍDELNÍM VOZE

TADY MŮŽETE  
POSLAT E-MAIL.



V KURÁČKEM VOZE

TADY MŮŽETE  
PARKOVAT.

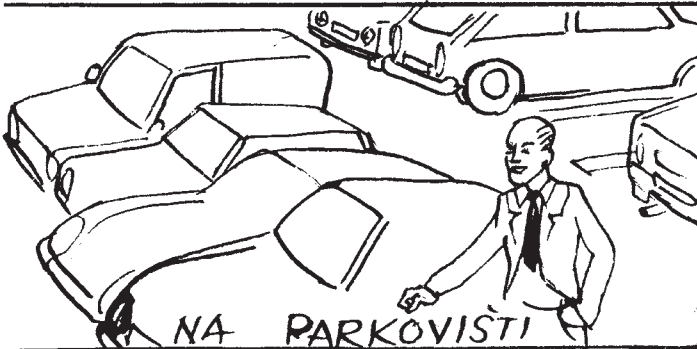

NA PARKOVIŠTI

TADY MŮŽETE  
KOUŘIT.

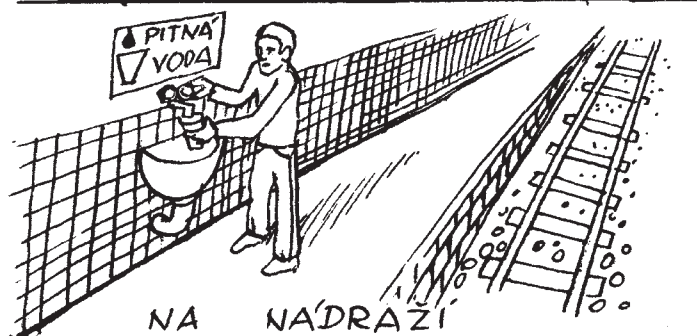

NA NÁDRAŽÍ

TADY MŮŽETE  
KOUPIŤ ZNAČKY.

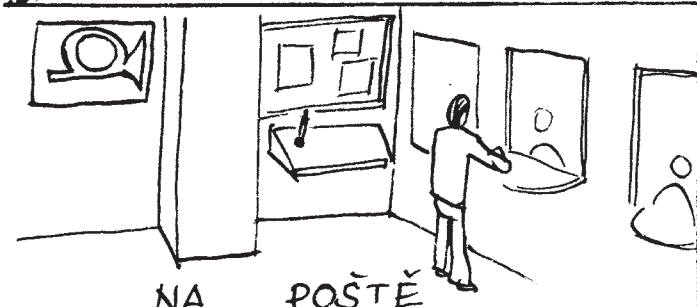

NA POŠTĚ

TADY MŮŽETE  
JÍST.

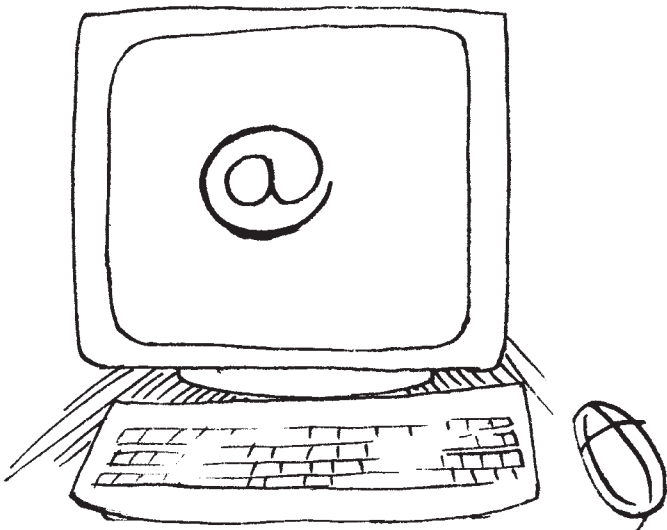
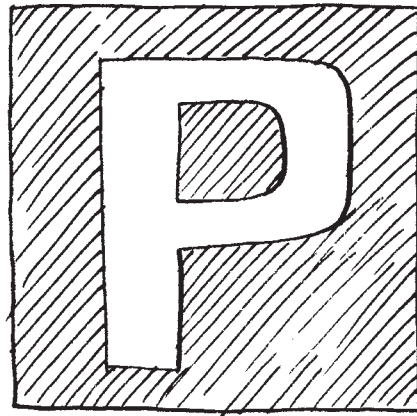
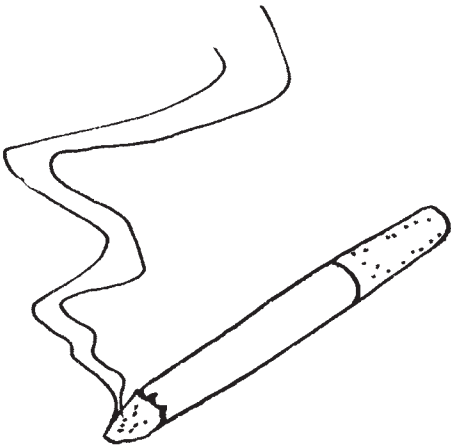
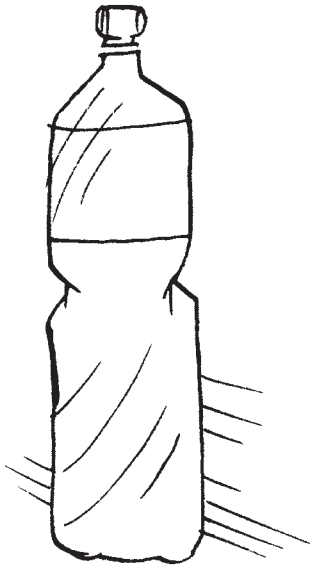

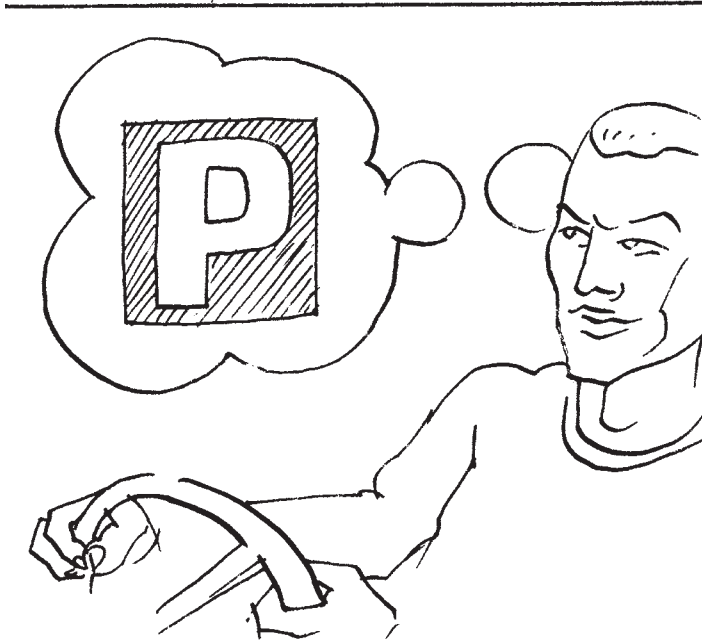
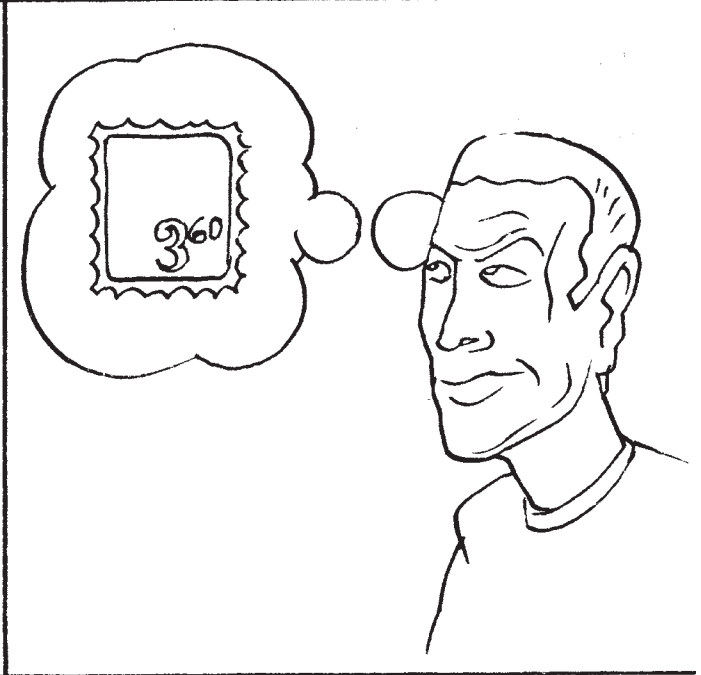

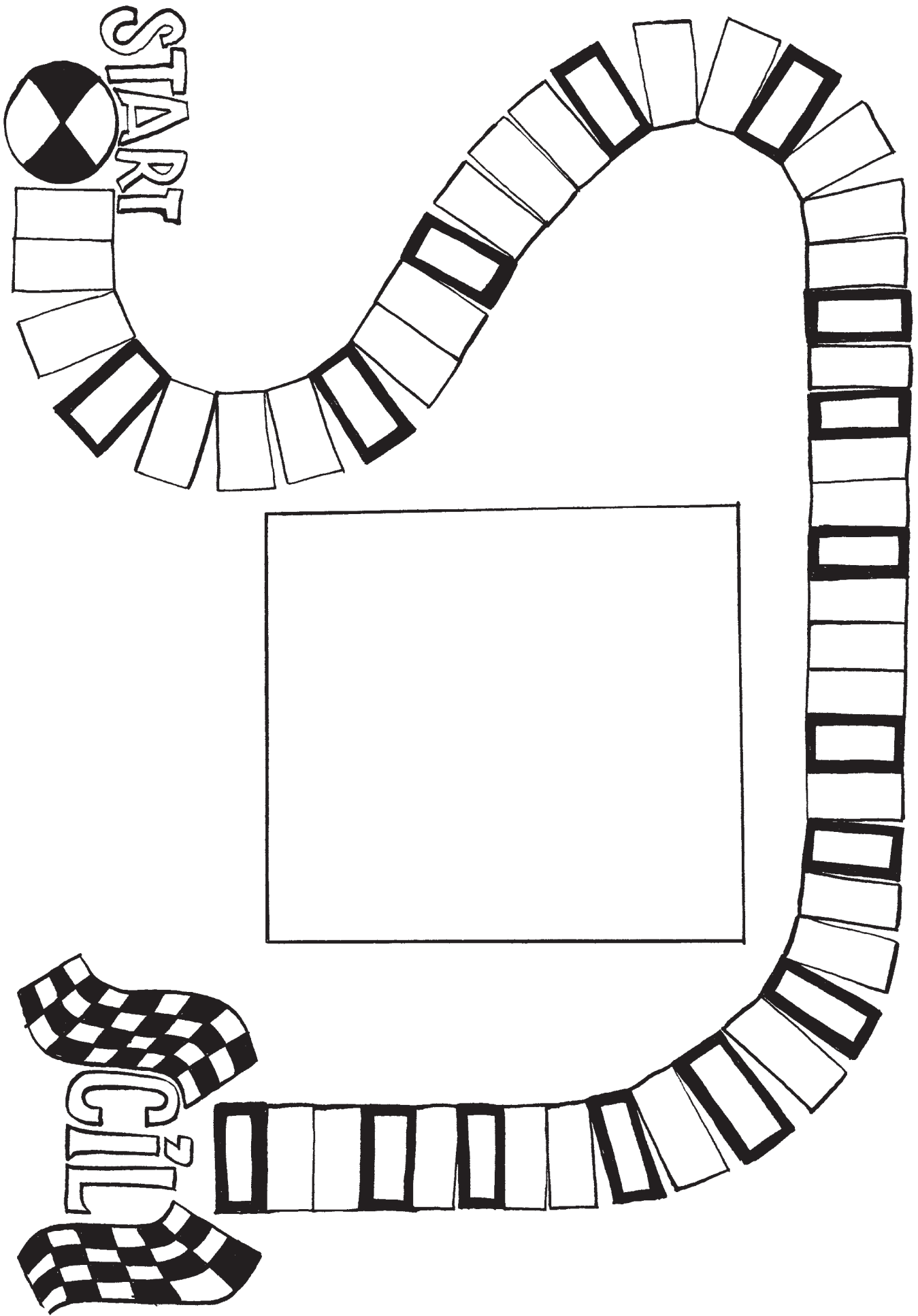

**Doplňte slovesa *mocet, chtít, smět a muset*:**

1. Zítra ..... (ty) brzo vstávat, protože tvoje letadlo letí v 8.30. 2. .... (já) dostat kávu, prosím? 3. .... (vy) čaj nebo kávu? 4. Tady ne..... kouřit, pane! 5. 6. Dnes večer ..... (já) jít na fotbal. 7. Dnes se ne..... učit, protože zítra nemám hodinu češtiny. 8. Děti se ne..... dívat na televizi, protože je pozdě a ..... jít spát. 9. .... (ty) , prosím tě, zavřít okno? 10. .... (vy) jít dnes večer do kina? 11. Můj kamarád ..... v létě cestovat, ale já ne..... jet s ním, protože ..... studovat na zkoušku. 12. Ne..... jet na výlet, protože nemám vůbec čas.

**Doplňte slovesa *mocet, chtít, smět a muset*:**

1. Zítra ..... (ty) brzo vstávat, protože tvoje letadlo letí v 8.30. 2. .... (já) dostat kávu, prosím? 3. .... (vy) čaj nebo kávu? 4. Tady ne..... kouřit, pane! 5. 6. Dnes večer ..... (já) jít na fotbal. 7. Dnes se ne..... učit, protože zítra nemám hodinu češtiny. 8. Děti se ne..... dívat na televizi, protože je pozdě a ..... jít spát. 9. .... (ty) , prosím tě, zavřít okno? 10. .... (vy) jít dnes večer do kina? 11. Můj kamarád ..... v létě cestovat, ale já ne..... jet s ním, protože ..... studovat na zkoušku. 12. Ne..... jet na výlet, protože nemám vůbec čas.

**Doplňte slovesa *mocet, chtít, smět a muset*:**

1. Zítra ..... (ty) brzo vstávat, protože tvoje letadlo letí v 8.30. 2. .... (já) dostat kávu, prosím? 3. .... (vy) čaj nebo kávu? 4. Tady ne..... kouřit, pane! 5. 6. Dnes večer ..... (já) jít na fotbal. 7. Dnes se ne..... učit, protože zítra nemám hodinu češtiny. 8. Děti se ne..... dívat na televizi, protože je pozdě a ..... jít spát. 9. .... (ty) , prosím tě, zavřít okno? 10. .... (vy) jít dnes večer do kina? 11. Můj kamarád ..... v létě cestovat, ale já ne..... jet s ním, protože ..... studovat na zkoušku. 12. Ne..... jet na výlet, protože nemám vůbec čas.

**Doplňte slovesa *mocet, chtít, smět a muset*:**

1. Zítra ..... (ty) brzo vstávat, protože tvoje letadlo letí v 8.30. 2. .... (já) dostat kávu, prosím? 3. .... (vy) čaj nebo kávu? 4. Tady ne..... kouřit, pane! 5. 6. Dnes večer ..... (já) jít na fotbal. 7. Dnes se ne..... učit, protože zítra nemám hodinu češtiny. 8. Děti se ne..... dívat na televizi, protože je pozdě a ..... jít spát. 9. .... (ty) , prosím tě, zavřít okno? 10. .... (vy) jít dnes večer do kina? 11. Můj kamarád ..... v létě cestovat, ale já ne..... jet s ním, protože ..... studovat na zkoušku. 12. Ne..... jet na výlet, protože nemám vůbec čas.



Tento manuál vznikl v rámci spolupráce  
s projektem Varianty – IKV, který realizuje  
Člověk v tísni – společnost při ČT, o. p. s.

---

Iniciativa Společenství  
**EQUAL**



Projekt je financován z prostředků iniciativy Equal a ze státního rozpočtu České republiky